

bathroom  
solutions

*Leci Line.*



Tem alguma dúvida?  
Fale já conosco



**ITALBOX®**

A pensar em si

e no seu conforto



**MACOLIDE**

**+351 211 633 633**

**www.macolide.pt | info@macolide.pt**

**Banho | Cozinha | Revestimento**

# Índice

Index

## Resguardos de Duche Shower Screens **05**

LECI A SC8	06
LECI A	08
LECI A X10	10
LECI A N20	12
LECI B SC8	14
LECI B4	16
LECI B	18
LECI S21	22
LECI C	24
LECI M85	28

## Bases de Duche Shower Tray **30**

STONESHALE	32
STONESHALE MINIMAL	34
STONESHALE PLUS	36

## Espelhos Mirror **38**

OVAL RETROILUMINADO NEP	40
REDONDO RETROILUMINADO NEP	41
RETROILUMINADO H NEP	42
ESPELHOS AUMENTO	44

## Acessórios Accessories **46**

TOALHEIROS ELECTRICOS	48
ACESSÓRIOS WC	52

**resguardos de duche**  
shower screen



# LECI A SC8



Anti-calcário  
Coating

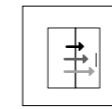

Fecho soft-close  
Soft-close system

Perfis em alumínio cromado.  
Vidro temperado de 6mm.  
Altura: 2000mm.  
Com tratamento anti-calcário.

Aluminium chromed profiles.  
6mm tempered glass.  
Height: 2000mm.  
With coating treatment.

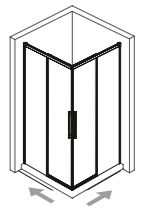

## Acabamentos . Finish

Perfil  
Profile



Cromado  
Chromed

Vidro  
Glass

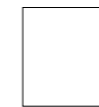

Transparente  
Transparent

Perfil  
Profile

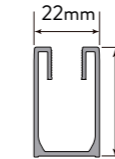

Perfil Vedação  
Floor Profile

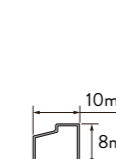

Puxador  
Handle

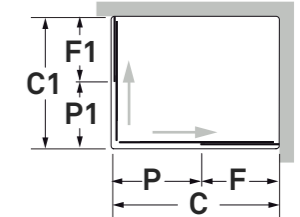
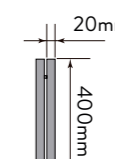

Referências Reference	Dimensões C x C1 (mm) Dimensions C x C1 (mm)	Afinações Adjustment	Preço Price
LCASC87070-V00C01	700 x 700	680-700 x 680-700	<b>420 €</b>
LCASC87075-V00C01	700 x 750	680-700 x 730-750	<b>425 €</b>
LCASC87080-V00C01	700 x 800	680-700 x 780-800	<b>430 €</b>
LCASC87090-V00C01	700 x 900	680-700 x 880-900	<b>435 €</b>
LCASC870100-V00C01	700 x 1000	680-700 x 980-1000	<b>445 €</b>
LCASC870120-V00C01	700 x 1200	680-700 x 1180-1200	<b>460 €</b>
LCASC87575-V00C01	750 x 750	730-750 x 730-750	<b>430 €</b>
LCASC87580-V00C01	750 x 800	730-750 x 780-800	<b>435 €</b>
LCASC87590-V00C01	750 x 900	730-750 x 880-900	<b>440 €</b>
LCASC875100-V00C01	750 x 1000	730-750 x 980-1000	<b>450 €</b>
LCASC875120-V00C01	750 x 1200	730-750 x 1180-1200	<b>465 €</b>
LCASC88080-V00C01	800 x 800	780-800 x 780-800	<b>440 €</b>
LCASC88090-V00C01	800 x 900	780-800 x 880-900	<b>445 €</b>
LCASC880100-V00C01	800 x 1000	780-800 x 980-1000	<b>455 €</b>
LCASC880120-V00C01	800 x 1200	780-800 x 1180-1200	<b>470 €</b>
LCASC89090-V00C01	900 x 900	880-900 x 880-900	<b>450 €</b>
LCASC890100-V00C01	900 x 1000	880-900 x 980-1000	<b>460 €</b>
LCASC890120-V00C01	900 x 1200	880-900 x 1180-1200	<b>475 €</b>
LCASC81010-V00C01	1000 x 1000	980-1000 x 980-1000	<b>470 €</b>
LCASC81012-V00C01	1000 x 1200	980-1000 x 1180-1200	<b>485 €</b>
LCASC81212-V00C01	1200 x 1200	1180-1200 x 1180-1200	<b>500 €</b>

	70	75	80	90	100	120
70	<b>420 €</b>	-	-	-	-	-
75	<b>425 €</b>	<b>430 €</b>	-	-	-	-
80	<b>430 €</b>	<b>435 €</b>	<b>440 €</b>	-	-	-
90	<b>435 €</b>	<b>440 €</b>	<b>445 €</b>	<b>450 €</b>	-	-
100	<b>445 €</b>	<b>450 €</b>	<b>455 €</b>	<b>460 €</b>	<b>470 €</b>	-
120	<b>460 €</b>	<b>465 €</b>	<b>470 €</b>	<b>475 €</b>	<b>485 €</b>	<b>500 €</b>



Perfis em alumínio cromado.  
Vidro temperado de 6mm.  
Altura: 2000mm.  
Com tratamento anti-calcário.

Aluminium chromed profiles.  
6mm tempered glass.  
Height: 2000mm.  
With coating treatment.

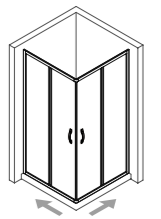

### Acabamentos . Finish

Perfil  
Profile



Cromado  
Chromed

Vidro  
Glass



Transparente  
Transparent

Perfil  
Profile

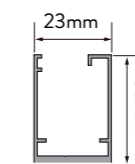

Perfil União  
Union Profile

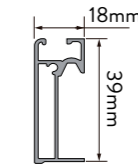

Puxador  
Handle

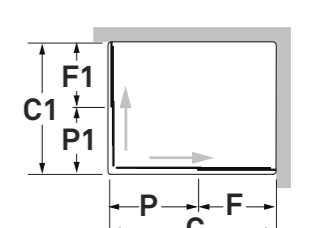
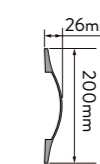

Referências Reference	Dimensões C x C1 (mm) Dimensions C x C1 (mm)	Afinações Adjustment	Preço Price
LCA7070-V00C01	700 x 700	680 - 700 x 680 - 700	<b>360€</b>
LCA7075-V00C01	700 x 750	680 - 700 x 730 - 750	<b>360€</b>
LCA7080-V00C01	700 x 800	680 - 700 x 780 - 800	<b>365€</b>
LCA7090-V00C01	700 x 900	680 - 700 x 880 - 900	<b>370€</b>
LCA70100-V00C01	700 x 1000	680 - 700 x 980 - 1000	<b>380€</b>
LCA70120-V00C01	700 x 1200	680 - 700 x 1180 - 1200	<b>395€</b>
LCA7575-V00C01	750 x 750	730 - 750 x 730 - 750	<b>360€</b>
LCA7580-V00C01	750 x 800	730 - 750 x 780 - 800	<b>365€</b>
LCA7590-V00C01	750 x 900	730 - 750 x 880 - 900	<b>370€</b>
LCA75100-V00C01	750 x 1000	730 - 750 x 980 - 1000	<b>380€</b>
LCA75120-V00C01	750 x 1200	730 - 750 x 1180 - 1200	<b>395€</b>
LCA8080-V00C01	800 x 800	780 - 800 x 780 - 800	<b>370€</b>
LCA8090-V00C01	800 x 900	780 - 800 x 780 - 900	<b>375€</b>
LCA80100-V00C01	800 x 1000	780 - 800 x 980 - 1000	<b>385€</b>
LCA80120-V00C01	800 x 1200	780 - 800 x 1180 - 1200	<b>400€</b>
LCA9090-V00C01	900 x 900	880 - 900 x 880 - 900	<b>380€</b>
LCA90100-V00C01	900 x 1000	880 - 900 x 980 - 1000	<b>390€</b>
LCA90120-V00C01	900 x 1200	880 - 900 x 1180 - 1200	<b>405€</b>
LCA100100-V00C01	1000 x 1000	980 - 1000 x 980 - 1000	<b>400€</b>
LCA100120-V00C01	1000 x 1200	980 - 1000 x 1180 - 1200	<b>415€</b>
LCA120120-V00C01	1200 x 1200	1180 - 1200 x 1180 - 1200	<b>430€</b>

	70	75	80	90	100	120
70	<b>360€</b>	-	-	-	-	-
75	<b>360€</b>	<b>360€</b>	-	-	-	-
80	<b>365€</b>	<b>365€</b>	<b>370€</b>	-	-	-
90	<b>370€</b>	<b>370€</b>	<b>375€</b>	<b>380€</b>	-	-
100	<b>380€</b>	<b>380€</b>	<b>385€</b>	<b>390€</b>	<b>400€</b>	-
120	<b>395€</b>	<b>395€</b>	<b>400€</b>	<b>405€</b>	<b>415€</b>	<b>430€</b>

# LECI A X10

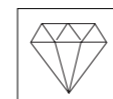

Anti-calcário  
Coating

Perfis em alumínio cromado.  
Vidro temperado de 6mm.  
Altura: 2000mm.  
Com tratamento anti-calcário.

Aluminium chromed profiles.  
6mm tempered glass.  
Height: 2000mm.  
With coating treatment.

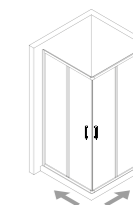

## Acabamentos . Finish

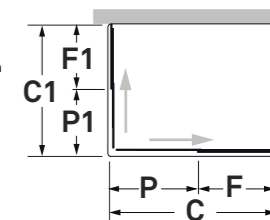
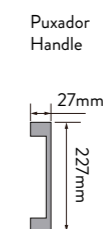
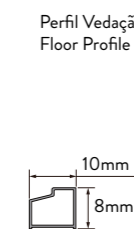
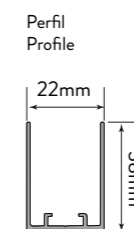

Referências (Cromado) Reference (Chromed)	Referências (Preto) Reference (Black)	Dimensões C x C1 (mm) Dimensions C x C1 (mm)	Afinações Adjustment	Preço Price
LCAX7070-V00C01	LCAX7070-V00P03	700 x 700	680 - 700 x 680 - 700	<b>340€</b>
LCAX7075-V00C01	LCAX7075-V00P03	700 x 750	680 - 700 x 730 - 750	<b>340€</b>
LCAX7080-V00C01	LCAX7080-V00P03	700 x 800	680 - 700 x 780 - 800	<b>340€</b>
LCAX7090-V00C01	LCAX7090-V00P03	700 x 900	680 - 700 x 880 - 900	<b>350€</b>
LCAX70100-V00C01	LCAX70100-V00P03	700 x 1000	680 - 700 x 980 - 1000	<b>355€</b>
LCAX70120-V00C01	LCAX70120-V00P03	700 x 1200	680 - 700 x 1180 - 1200	<b>360€</b>
LCAX7575-V00C01	LCAX7575-V00P03	750 x 750	730 - 750 x 730 - 750	<b>340€</b>
LCAX7580-V00C01	LCAX7580-V00P03	750 x 800	730 - 750 x 780 - 800	<b>340€</b>
LCAX7590-V00C01	LCAX7590-V00P03	750 x 900	730 - 750 x 880 - 900	<b>350€</b>
LCAX75100-V00C01	LCAX75100-V00P03	750 x 1000	730 - 750 x 980 - 1000	<b>355€</b>
LCAX75120-V00C01	LCAX75120-V00P03	750 x 1200	730 - 750 x 1180 - 1200	<b>360€</b>
LCAX8080-V00C01	LCAX8080-V00P03	800 x 800	780 - 800 x 780 - 800	<b>340€</b>
LCAX8090-V00C01	LCAX8090-V00P03	800 x 900	780 - 800 x 780 - 900	<b>350€</b>
LCAX80100-V00C01	LCAX80100-V00P03	800 x 1000	780 - 800 x 980 - 1000	<b>355€</b>
LCAX80120-V00C01	LCAX80120-V00P03	800 x 1200	780 - 800 x 1180 - 1200	<b>360€</b>
LCAX9090-V00C01	LCAX9090-V00P03	900 x 900	880 - 900 x 880 - 900	<b>360€</b>
LCAX90100-V00C01	LCAX90100-V00P03	900 x 1000	880 - 900 x 980 - 1000	<b>365€</b>
LCAX90120-V00C01	LCAX90120-V00P03	900 x 1200	880 - 900 x 1180 - 1200	<b>370€</b>
LCAX100100-V00C01	LCAX100100-V00P03	1000 x 1000	980 - 1000 x 980 - 1000	<b>370€</b>
LCAX100120-V00C01	LCAX100120-V00P03	1000 x 1200	980 - 1000 x 1180 - 1200	<b>375€</b>
LCAX120120-V00C01	LCAX120120-V00P03	1200 x 1200	1180 - 1200 x 1180 - 1200	<b>380€</b>

	70	75	80	90	100	120
70	<b>340€</b>	-	-	-	-	-
75	<b>340€</b>	<b>340€</b>	-	-	-	-
80	<b>340€</b>	<b>340€</b>	<b>340€</b>	-	-	-
90	<b>350€</b>	<b>350€</b>	<b>350€</b>	<b>360€</b>	-	-
100	<b>355€</b>	<b>355€</b>	<b>355€</b>	<b>365€</b>	<b>370€</b>	-
120	<b>360€</b>	<b>360€</b>	<b>360€</b>	<b>370€</b>	<b>375€</b>	<b>380€</b>

# LECI A N20



Perfis em alumínio cromado.  
Vidro temperado de 6mm.  
Altura: 2000mm.  
Com tratamento anti-calcário.

Aluminium chromed profiles.  
6mm tempered glass.  
Height: 2000mm.  
With coating treatment.

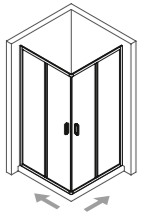

## Acabamentos . Finish

Perfil  
Profile



Cromado  
Chromed

Vidro  
Glass



Transparente  
Transparent

Perfil  
Profile

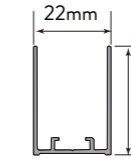

Perfil União  
Union Profile

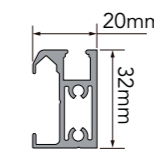

Puxador  
Handle

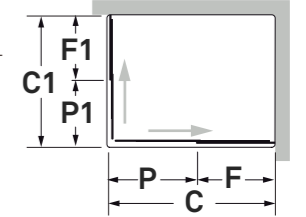
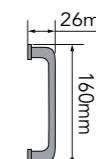

Referências Reference	Dimensões C x C1 (mm) Dimensions C x C1 (mm)	Afinações Adjustment	Preço Price
LCAN7070-V00C01	700 x 700	680 - 700 x 680 - 700	310€
LCAN7075-V00C01	700 x 750	680 - 700 x 730 - 750	310€
LCAN7080-V00C01	700 x 800	680 - 700 x 780 - 800	310€
LCAN7090-V00C01	700 x 900	680 - 700 x 880 - 900	315€
LCAN70100-V00C01	700 x 1000	680 - 700 x 980 - 1000	325€
LCAN70120-V00C01	700 x 1200	680 - 700 x 1180 - 1200	330€
LCAN7575-V00C01	750 x 750	730 - 750 x 730 - 750	310€
LCAN7580-V00C01	750 x 800	730 - 750 x 780 - 800	310€
LCAN7590-V00C01	750 x 900	730 - 750 x 880 - 900	315€
LCAN75100-V00C01	750 x 1000	730 - 750 x 980 - 1000	325€
LCAN75120-V00C01	750 x 1200	730 - 750 x 1180 - 1200	330€
LCAN8080-V00C01	800 x 800	780 - 800 x 780 - 800	310€
LCAN8090-V00C01	800 x 900	780 - 800 x 780 - 900	315€
LCAN80100-V00C01	800 x 1000	780 - 800 x 980 - 1000	325€
LCAN80120-V00C01	800 x 1200	780 - 800 x 1180 - 1200	330€
LCAN9090-V00C01	900 x 900	880 - 900 x 880 - 900	320€
LCAN90100-V00C01	900 x 1000	880 - 900 x 980 - 1000	330€
LCAN90120-V00C01	900 x 1200	880 - 900 x 1180 - 1200	335€
LCAN100100-V00C01	1000 x 1000	980 - 1000 x 980 - 1000	340€
LCAN100120-V00C01	1000 x 1200	980 - 1000 x 1180 - 1200	345€
LCAN120120-V00C01	1200 x 1200	1180 - 1200 x 1180 - 1200	350€

	70	75	80	90	100	120
70	310€	-	-	-	-	-
75	310€	310€	-	-	-	-
80	310€	310€	310€	-	-	-
90	315€	315€	315€	320€	-	-
100	325€	325€	325€	330€	340€	-
120	330€	330€	330€	335€	345€	350€

# LECI B SC8

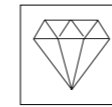

Anti-calcário  
Coating

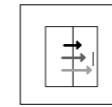

Fecho soft-close  
Soft-close system

Perfis em alumínio cromado.  
Vidro temperado de 6mm.  
Altura: 2000mm.  
Com tratamento anti-calcário.

Aluminium chromed profiles.  
6mm tempered glass.  
Height: 2000mm.  
With coating treatment.

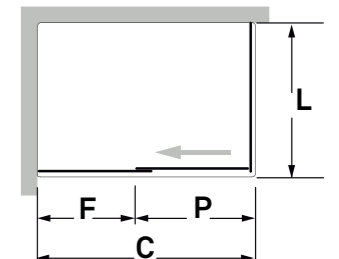
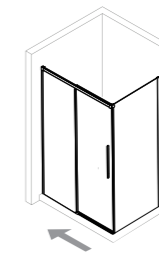
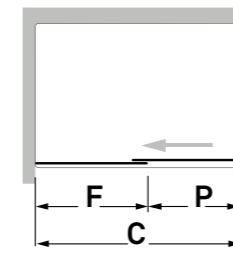
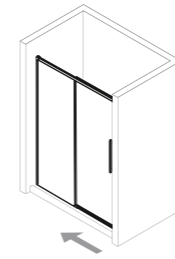

## Acabamentos . Finish

Perfil  
Profile



Cromado  
Chromed

Vidro  
Glass



Transparente  
Transparent

Perfil  
Profile

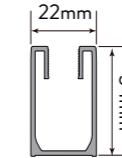

Perfil Vedação  
Floor Profile

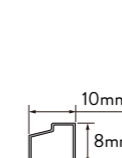

Puxador  
Handle

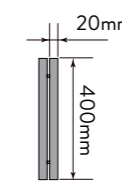

Referências Reference	Dimensões C (mm) Dimensions C (mm)	Afinações Adjustment	Preço Price
		Frontal Frontal	
LCBSC8120-V00C01	1200	1185-1200	<b>330€</b>
LCBSC8130-V00C01	1300	1285-1300	<b>340€</b>
LCBSC8140-V00C01	1400	1385-1400	<b>350€</b>
LCBSC8150-V00C01	1500	1485-1500	<b>360€</b>
LCBSC8160-V00C01	1600	1585-1600	<b>375€</b>
LCBSC8170-V00C01	1700	1685-1700	<b>385€</b>
LCBSC8180-V00C01	1800	1785-1800	<b>395€</b>
LCBSC8190-V00C01	1900	1885-1900	<b>460€</b>
LCBSC8200-V00C01	2000	1985-2000	<b>470€</b>
		Lateral   Side Panel	
		Dimensões L (mm) Dimensions L (mm)	
LCBSCL870-V00C01	700	685-700	<b>155€</b>
LCBSCL875-V00C01	750	735-750	<b>160€</b>
LCBSCL880-V00C01	800	785-800	<b>165€</b>
LCBSCL890-V00C01	900	885-900	<b>175€</b>

# LECI B4

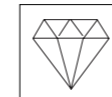

Anti-calcário  
Coating

Perfis em alumínio cromado.  
Vidro temperado de 6mm.  
Altura: 2000mm.  
Com tratamento anti-calcário.

Aluminium chromed profiles.  
6mm tempered glass.  
Height: 2000mm.  
With coating treatment.

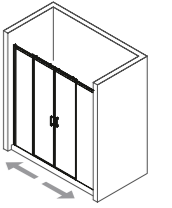

## Acabamentos . Finish

Perfil  
Profile



Cromado  
Chromed

Vidro  
Glass



Transparente  
Transparent

Perfil  
Profile

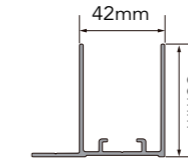

Perfil União  
Union Profile

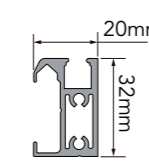

Puxador  
Handle

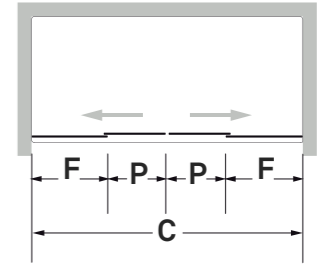
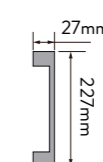

Referências Reference	Dimensões C (mm) Dimensions C (mm)	Afinações Adjustment	Preço Price
LCB4150-V00C01	1500	1460-1560	<b>340 €</b>
LCB4160-V00C01	1600	1560 - 1660	<b>345 €</b>
LCB4170-V00C01	1700	1660 - 1760	<b>350 €</b>
LCB4180-V00C01	1800	1760 - 1860	<b>360 €</b>
LCB4190-V00C01	1900	1860 - 1960	<b>370 €</b>
LCB4200-V00C01	2000	1960 - 2060	<b>380 €</b>

# LECI B



# LECI B



Perfis em alumínio cromado.  
Vidro temperado de 6mm.  
Altura: 2000mm.  
Com tratamento anti-calcário.

Aluminium chromed profiles.  
6mm tempered glass.  
Height: 2000mm.  
With coating treatment.

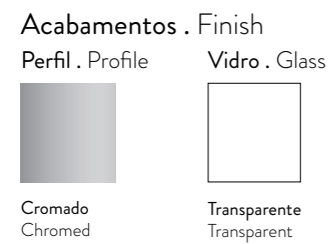
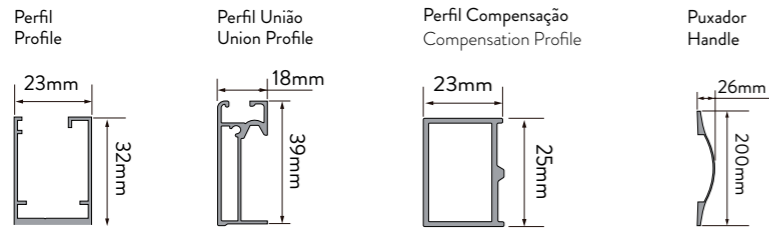
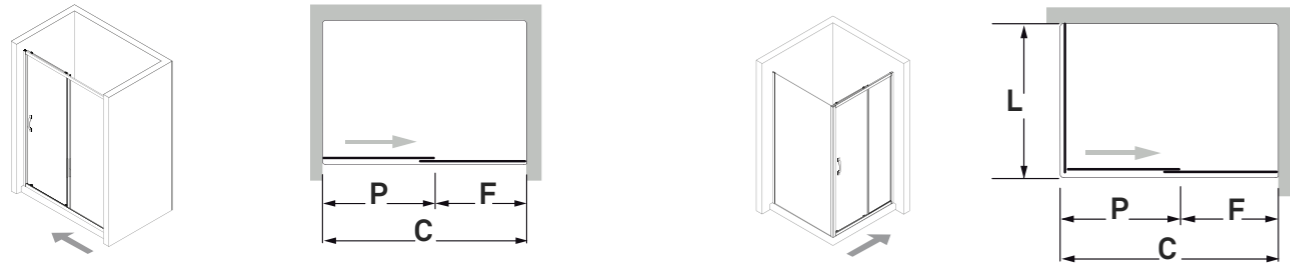

Referências Reference	Dimensões C (mm) Dimensions C (mm)	Afinações Adjustment		Preço Price
		Frontal (C) Frontal (C)	Frontal + Lateral ( C x L) Frontal + Side panel ( C x L)	
LCB100-V00C01	1000	970-1000	981-1011	<b>250 €</b>
LCB102-V00C01	(a)	970-1022	981-1033	<b>280 €</b>
LCB104-V00C01	(b)	970-1045	981-1055	<b>300 €</b>
LCB107-V00C01	(c)	1045-1075	1055-1085	<b>280 €</b>
LCB110-V00C01	1100	1070-1100	1081-1111	<b>260 €</b>
LCB112-V00C01	(a)	1070-1122	1081-1133	<b>290 €</b>
LCB114-V00C01	(b)	1070-1145	1081-1155	<b>315 €</b>
LCB117-V00C01	(c)	1145-1175	1155-1185	<b>290 €</b>
LCB120-V00C01	1200	1170-1200	1181-1211	<b>270 €</b>
LCB122-V00C01	(a)	1170-1222	1181-1233	<b>300 €</b>
LCB124-V00C01	(b)	1170-1245	1181-1255	<b>325 €</b>
LCB127-V00C01	(c)	1245-1275	1255-1285	<b>300 €</b>
LCB130-V00C01	1300	1270-1300	1281-1311	<b>280 €</b>
LCB132-V00C01	(a)	1270-1322	1281-1333	<b>310 €</b>
LCB134-V00C01	(b)	1270-1345	1281-1355	<b>335 €</b>
LCB137-V00C01	(c)	1245-1375	1355-1385	<b>310 €</b>
LCB140-V00C01	1400	1370-1400	1371-1411	<b>290 €</b>
LCB142-V00C01	(a)	1370-1422	1381-1433	<b>320 €</b>
LCB144-V00C01	(b)	1370-1445	1381-1455	<b>345 €</b>
LCB147-V00C01	(c)	1445-1475	1455-1485	<b>320 €</b>
LCB150-V00C01	1500	1470-1500	1481-1511	<b>300 €</b>
LCB152-V00C01	(a)	1470-1522	1481-1533	<b>330 €</b>
LCB154-V00C01	(b)	1470-1545	1481-1555	<b>355 €</b>
LCB157-V00C01	(c)	1545-1575	1555-1585	<b>330 €</b>
LCB160-V00C01	1600	1570-1600	1581-1611	<b>310 €</b>
LCB162-V00C01	(a)	1570-1622	1581-1633	<b>340 €</b>
LCB164-V00C01	(b)	1570-1645	1581-1655	<b>365 €</b>
LCB170-V00C01	1700	1670 - 1700	1681 - 1722	<b>320€</b>
LCB180-V00C01	1800	1770 - 1800	1781 - 1811	<b>330€</b>
Lateral   Side Panel	Dimensões L (mm) Dimensions L (mm)			
LCBL70-V00C01	700	688 - 700		<b>155 €</b>
LCBL80-V00C01	800	788 - 800		<b>160 €</b>
LCBL90-V00C01	900	888 - 900		<b>170 €</b>

(a) com um perfil de compensação 22,5mm (b) com dois perfis de compensação 22,5mm (c) com corte de 25mm ou fornecimento de travessas extras

# LECI B S21



Perfis em alumínio cromado.  
Vidro temperado de 6mm.  
Altura: 2000mm.  
Com tratamento anti-calcário.

Aluminium chromed profiles.  
6mm tempered glass.  
Height: 2000mm.  
With coating treatment.

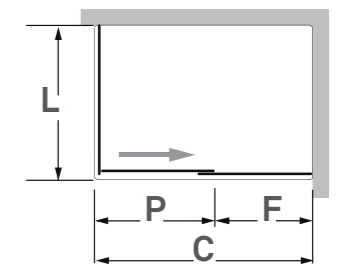
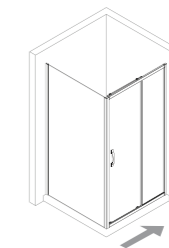
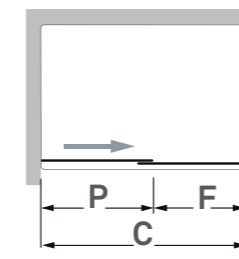

## Acabamentos . Finish

Perfil  
Profile



Cromado  
Chromed

Perfil  
Profile



Preto  
Black

Vidro  
Glass



Transparente  
Transparent

Perfil  
Profile

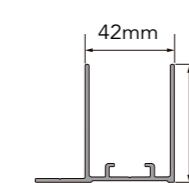

Perfil União  
Union Profile

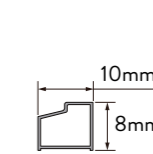

Perfil Compensação  
Compensation Profile

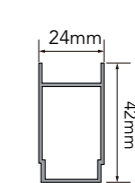

Puxador  
Handle

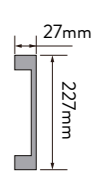

Referências (Cromado) Reference (Chromed)	Referências (Preto) Reference (Black)	Dimensões C (mm) Dimensions C (mm)	Afinações Adjustment	Preço Price
LCBS120-V00C01	LCBS120-V00P03	1200	1160-1260	<b>275 €</b>
LCBS130-V00C01	LCBS130-V00P03	1300	1260-1360	<b>280 €</b>
LCBS140-V00C01	LCBS140-V00P03	1400	1360-1460	<b>285 €</b>
LCBS150-V00C01	LCBS150-V00P03	1500	1460-1560	<b>295 €</b>
LCBS160-V00C01	LCBS160-V00P03	1600	1560-1660	<b>300 €</b>
LCBS170-V00C01	LCBS170-V00P03	1700	1660-1760	<b>310 €</b>
LCBS180-V00C01	LCBS180-V00P03	1800	1760-1860	<b>315 €</b>
Lateral   Side Panel		Dimensões L (mm) Dimensions L (mm)		
LCBSL70-V00C01	LCBSL70-V00P03	700	680 -700	<b>160 €</b>
LCBSL75-V00C01	LCBSL75-V00P03	750	730 -750	<b>160 €</b>
LCBSL80-V00C01	LCBSL80-V00P03	800	780 - 800	<b>165 €</b>
LCBSL90-V00C01	LCBSL90-V00P03	900	880 - 900	<b>170 €</b>

# LECI C



# LECI C

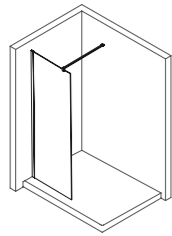

Perfis em alumínio cromado.  
Vidro temperado de 8mm.  
Altura: 2000mm.  
Com tratamento anti-calcário.

Aluminium chromed profiles.  
8mm tempered glass.  
Height: 2000mm.  
With coating treatment.

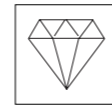

Anti-calcário  
Coating

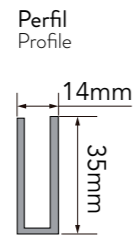
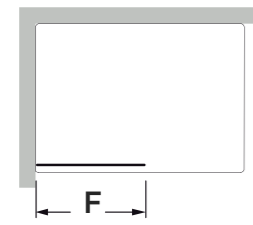

## Acabamentos . Finish

Perfil  
Profile



Cromado  
Chromed



Preto  
Black

Vidro  
Profile



Transparente  
Transparent

	Referências Reference	Dimensões F (mm) Dimensions F (mm)	Preço Price
Cromado Chromed	LCC80-V00C01	800	170 €
	LCC90-V00C01	900	185 €
	LCC100-V00C01	1000	195 €
	LCC110-V00C01	1100	205 €
	LCC120-V00C01	1200	215 €
Preto Black	LCC80-V00P03	800	170 €
	LCC90-V00P03	900	185 €
	LCC100-V00P03	1000	195 €
	LCC110-V00P03	1100	205 €
	LCC120-V00P03	1200	215 €

# LECI PAINEL MÓVEL



Anti-calcário  
Coating

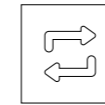

Reversível  
Reversible

Painel móvel reversível para  
ampliar ao modelo Leci C.  
Perfis em alumínio cromado.  
Vidro temperado de 8mm.  
Dimensões: 300 x2000mm.  
Com tratamento anti-calcário.

Reversible mobile panel  
for Leci C model.  
Aluminum chromed profiles.  
8mm tempered glass.  
Dimensions 300 x 2000mm.  
With coating treatment.

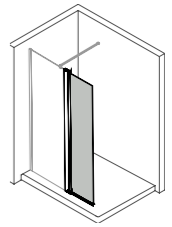

## Acabamentos . Finish

Perfil  
Profile



Cromado  
Chromed



Preto  
Black

Vidro  
Profile



Transparente  
Transparent

Perfil  
Profile

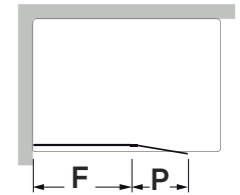
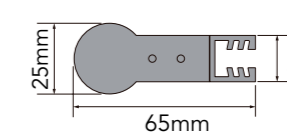

	Referências Reference	Dimensões P (mm) Dimensions P (mm)	Preço Price
Cromado Chromed	LCP30-V00C01	300	125€
Preto Black	LCP30-V00P03	300	125 €

# LECI M85

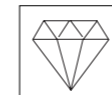

Anti-calcário  
Coating

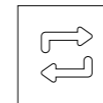

Reversível  
Reversible

Perfis em alumínio cromado.  
Vidro temperado de 6mm.  
Altura: 1500mm.  
Com tratamento anti-calcário.

Aluminium chromed profiles.  
6mm tempered glass.  
Height: 1500mm.  
With coating treatment.

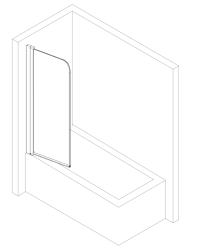

## Acabamentos . Finish

Perfil  
Profile



Cromado  
Chromed

Vidro  
Glass



Transparente  
Transparent

Perfil  
Profile

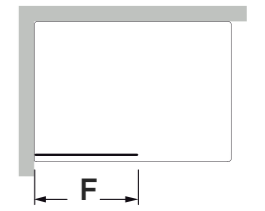
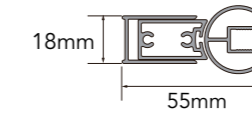

Referências  
Reference

Dimensões F (mm)  
Dimensions F (mm)

Preço  
Price

LCM85-V00C01

850

**125€**

**bases de duche**  
shower tray



# STONESHALE



Base de duche produzida em Termo fusão entre Gelcoat ISO/ NPG, com cargas minerais e resinas.  
Válvula, grelha e manual de aplicação/instalação incluído.  
Base em outras cores (carta RAL) acrescenta 50€/uni.  
Nas medidas intermédias o preço é sobre a medida maior (ex. 164x73= à medida 170 x 80) + custo corte.  
Corte para medidas intermédias 40€/uni.

Shower case in produced in thermofusion between Gelcoat ISO/ NPG, with mineral fillers and resins.  
Valve, grille and application/ installation manual included.  
Others colors (Ral) adds 50€/uni.  
In intermediate measures the price is on the largest measure (ex. 164 x 73= 170 x 80 measure) + cutting cost.  
Cut for intermediate measures 40€/uni.

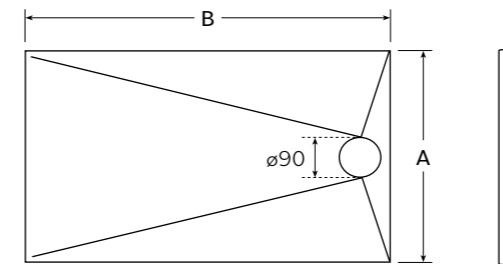

## Acabamentos . Finish



## Tolerância . Tolerance ± 2%

	70	75	80	90	100	120
70	<b>160 €</b>	-	-	-	-	-
80	<b>175 €</b>	<b>200 €</b>	<b>200 €</b>	-	-	-
90	<b>200 €</b>	<b>215 €</b>	<b>225 €</b>	<b>250 €</b>	-	-
100	<b>220 €</b>	<b>235 €</b>	<b>245 €</b>	<b>275 €</b>	<b>300 €</b>	-
110	<b>235 €</b>	<b>250 €</b>	<b>270 €</b>	<b>300 €</b>	<b>335 €</b>	-
120	<b>260 €</b>	<b>275 €</b>	<b>290 €</b>	<b>330 €</b>	<b>360 €</b>	<b>435 €</b>
130	<b>275 €</b>	<b>295 €</b>	<b>315 €</b>	<b>355 €</b>	<b>395 €</b>	<b>470 €</b>
140	<b>300 €</b>	<b>320 €</b>	<b>335 €</b>	<b>380 €</b>	<b>420 €</b>	<b>505 €</b>
150	<b>320 €</b>	<b>340 €</b>	<b>360 €</b>	<b>405 €</b>	<b>450 €</b>	<b>545 €</b>
160	<b>335 €</b>	<b>365 €</b>	<b>390 €</b>	<b>435 €</b>	<b>485 €</b>	<b>575 €</b>
170	<b>360 €</b>	<b>385 €</b>	<b>410 €</b>	<b>460 €</b>	<b>510 €</b>	<b>620 €</b>
180	<b>380 €</b>	<b>405 €</b>	<b>435 €</b>	<b>490 €</b>	<b>540 €</b>	<b>655 €</b>
190	<b>400 €</b>	<b>430 €</b>	<b>460 €</b>	<b>520 €</b>	<b>575 €</b>	<b>690 €</b>
200	<b>420 €</b>	<b>450 €</b>	<b>475 €</b>	<b>545 €</b>	<b>600 €</b>	<b>730 €</b>
210	<b>440 €</b>	<b>475 €</b>	<b>505 €</b>	<b>570 €</b>	<b>635 €</b>	<b>760 €</b>
215	<b>465 €</b>	<b>410 €</b>	<b>530 €</b>	<b>600 €</b>	<b>665 €</b>	<b>805 €</b>

# STONESHALE MINIMAL



Base de duche produzida em Termo fusão entre Gelcoat ISO/ NPG, com cargas minerais e resinas.  
Válvula, grelha e manual de aplicação/instalação incluído.  
Base em outras cores (carta RAL) acrescenta 50€/uni.  
Nas medidas intermédias o preço é sobre a medida maior (ex. 164x73= à medida 170 x 80) + custo corte.  
Corte para medidas intermédias 40€/uni.

Shower case in produced in thermofusion between Gelcoat ISO/ NPG, with mineral fillers and resins.  
Valve, grille and application/ installation manual included.  
Others colors (Ral) adds 50€/uni.  
In intermediate measures the price is on the largest measure (ex. 164 x 73= 170 x 80 measure) + cutting cost.  
Cut for intermediate measures 40€/uni.

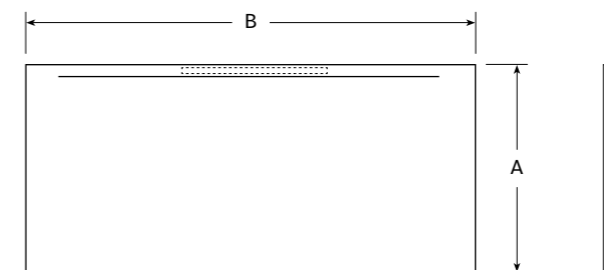

## Acabamentos . Finish

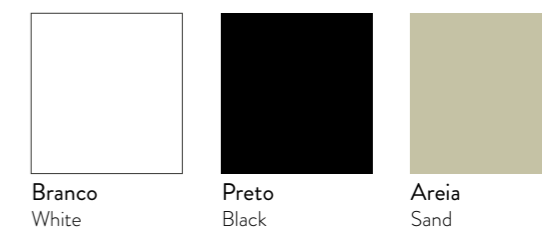

## Tolerância . Tolerance ± 2%

	70	80	90	100	120	140
70	260 €	-	-	-	-	-
80	285 €	285 €	-	-	-	-
90	285 €	315 €	355 €	-	-	-
100	315 €	325 €	365 €	500 €	-	-
110	345 €	355 €	415 €	535 €	-	-
120	355 €	365 €	425 €	545 €	685 €	-
130	380 €	415 €	485 €	615 €	805 €	-
140	390 €	445 €	500 €	630 €	805 €	1040 €
150	415 €	475 €	545 €	700 €	920 €	1160 €
160	445 €	510 €	555 €	720 €	920 €	1160 €
170	500 €	545 €	605 €	735 €	1040 €	1300 €
180	520 €	565 €	630 €	760 €	1040 €	1300 €
190	585 €	605 €	675 €	840 €	1170 €	1430 €
200	615 €	630 €	700 €	850 €	1170 €	1430 €
220	675 €	700 €	850 €	890 €	1430 €	1690 €
250	830 €	890 €	1125 €	1170 €	1560 €	1950 €
280	1180 €	1245 €	1480 €	1535 €	1950 €	2210 €

# STONESHALE PLUS



Base de duche produzida em Termo fusão entre Gelcoat ISO/ NPG, com cargas minerais e resinas.  
Válvula, grelha e manual de aplicação/instalação incluído.  
Base em outras cores (carta RAL) acrescenta 50€/uni.  
Nas medidas intermédias o preço é sobre a medida maior (ex. 164x73= à medida 170 x 80) + custo corte.  
Corte para medidas intermédias 40€/uni.

Shower case in produced in thermofusion between Gelcoat ISO/ NPG, with mineral fillers and resins.  
Valve, grille and application/ installation manual included.  
Others colors (Ral) adds 50€/uni.  
In intermediate measures the price is on the largest measure (ex. 164 x 73= 170 x 80 measure) + cutting cost.  
Cut for intermediate measures 40€/uni.

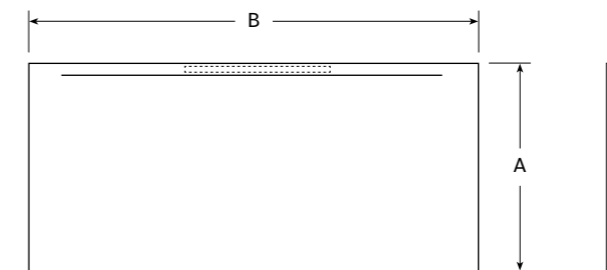

## Acabamentos . Finish

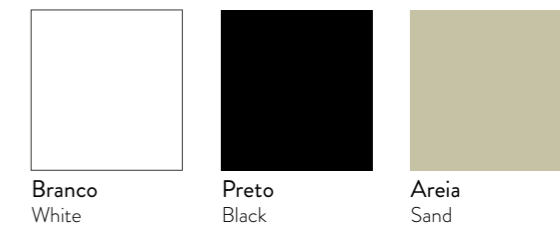

## Tolerância . Tolerance ± 2%

	70	80	90
80	-	<b>270 €</b>	-
90	-	-	<b>300 €</b>
100	<b>270 €</b>	<b>300 €</b>	<b>335 €</b>
110	<b>290 €</b>	<b>335 €</b>	<b>365 €</b>
120	<b>320 €</b>	<b>365 €</b>	<b>400 €</b>
130	<b>335 €</b>	<b>385 €</b>	<b>435 €</b>
140	<b>360 €</b>	<b>410 €</b>	<b>465 €</b>
150	<b>400 €</b>	<b>450 €</b>	<b>500 €</b>
160	<b>420 €</b>	<b>465 €</b>	<b>535 €</b>
170	<b>450 €</b>	<b>500 €</b>	<b>565 €</b>
180	<b>465 €</b>	<b>535 €</b>	<b>600 €</b>
190	<b>500 €</b>	<b>565 €</b>	<b>635 €</b>
200	<b>535 €</b>	<b>600 €</b>	<b>665 €</b>
210	<b>565 €</b>	<b>635 €</b>	<b>700 €</b>

**espelhos**  
mirrors



**ITALBOX<sup>®</sup>**

# OVAL RETROILUMINADO NEP



Material: Estrutura em alumínio + cobertura;  
Espelho prateado sem cobre (5 mm)  
Interrutor tátil on/off, função de desembaciador;  
IP44;  
Temperatura de cor do led: 2700K;  
Interruptores separados para controlar a iluminação e o desembaciador;

Material: aluminium frame+pc cover  
Copper free silver mirror (5mm)  
On/off touch switch, defogger function,  
IP44;  
Led color temperature: 2700K;  
Separate switches to control lighting and defogger;

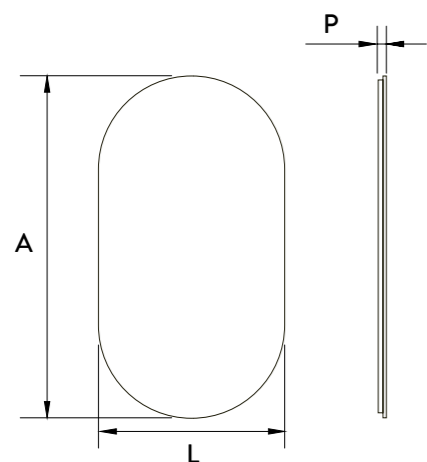

Referências Reference	Dimensões L x A x P (mm) Dimensions L x A x P (mm)	Preço Price
OM11-067C01	600 x 1000 x 40	<b>220€</b>

# REDONDO RETROILUMINADO NEP



Material: Estrutura em alumínio + cobertura;  
Espelho prateado sem cobre (5 mm)  
Interrutor tátil on/off, função de desembaciador;  
IP44;  
Temperatura de cor do led: 2700K;  
Interruptores separados para controlar a iluminação e o desembaciador;

Material: aluminium frame+pc cover  
Copper free silver mirror (5mm)  
On/off touch switch, defogger function,  
IP44;  
Led color temperature: 2700K;  
Separate switches to control lighting and defogger;

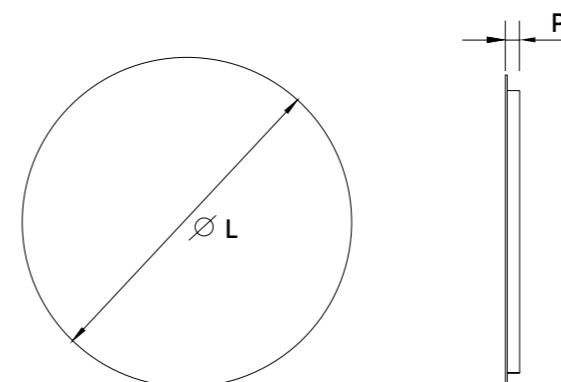

Referências Reference	Dimensões L x P (mm) Dimensions L x P (mm)	Preço Price
OM11-083C01	600 X 40	<b>165€</b>
OM11-107C01	800 X 40	<b>220€</b>

# RETROILUMINADO H NEP



Material: Estrutura em alumínio + cobertura;  
 Espelho prateado sem cobre (5 mm)  
 Interruptor tátil on/off, função de desembaciador;  
 IP44;  
 Temperatura de cor do led: 2700K;  
 Interruptores separados para controlar a iluminação e o desembaciador;

Material: aluminium frame+pc cover  
 Copper free silver mirror (5mm)  
 On/off touch switch, defogger function,  
 IP44;  
 Led color temperature: 2700K;  
 Separate switches to control lighting and defogger;

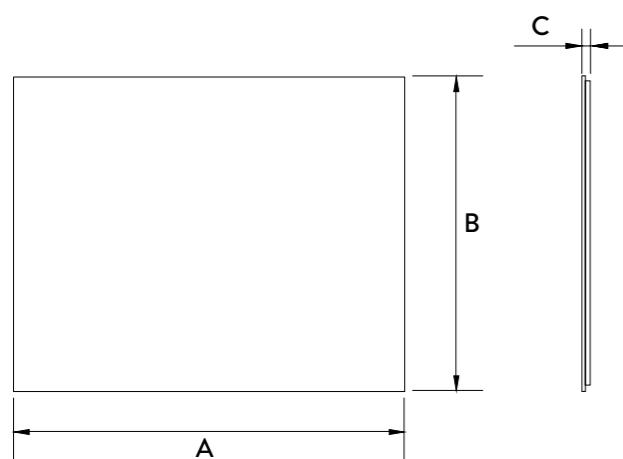

Referências Reference	Dimensões AxBxC (mm) Dimensions AxBxC (mm)	Preço Price
OM11-080C01	600 x 800 x 40	<b>195€</b>
OM11-089C01	700 x 800 x 40	<b>200€</b>
OM11-085C01	800 x 800 x 40	<b>210€</b>
OM11-090C01	900 x 800 x 40	<b>220€</b>
OM11-073C01	1000 x 800 x 40	<b>225€</b>
OM11-074C01	1200 x 800 x 40	<b>245€</b>
OM11-091C01	1300 x 800 x 40	<b>250€</b>
OM11-092C01	1400 x 800 x 40	<b>260€</b>

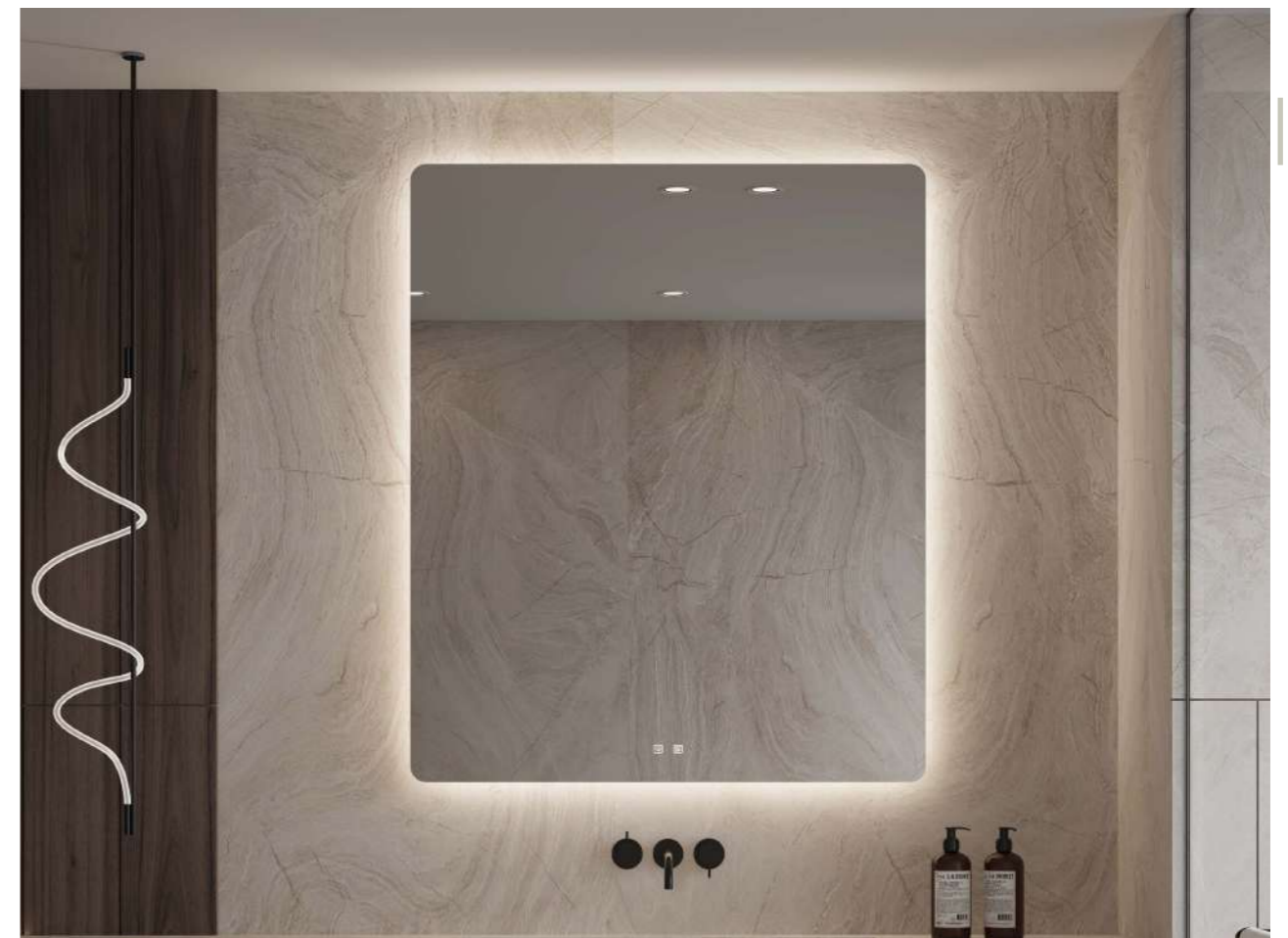

# HBY3006

Espelho simples de aumento . Amplified mirror

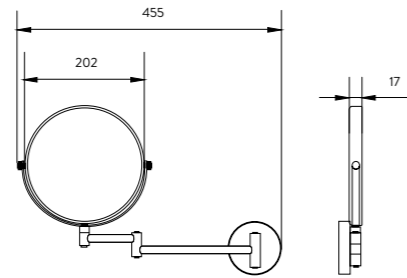

- Espelhos simples de aumento
- Amplificação até 3x
- Ajuste de ângulo rotativo de 360°

Cromado    Preto  
Chromed    Black

35€

# HBY1010

Espelho aumento com Led . Amplified mirror

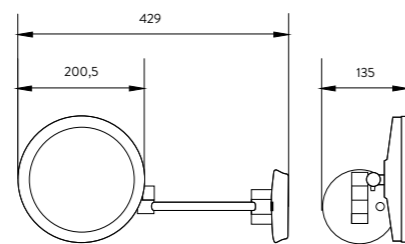

- Espelho de aumento com Led
- Interruptor touch
- Amplificação até 3x
- Ajuste de ângulo rotativo de 360°

Cromado    Preto  
Chromed    Black

110€

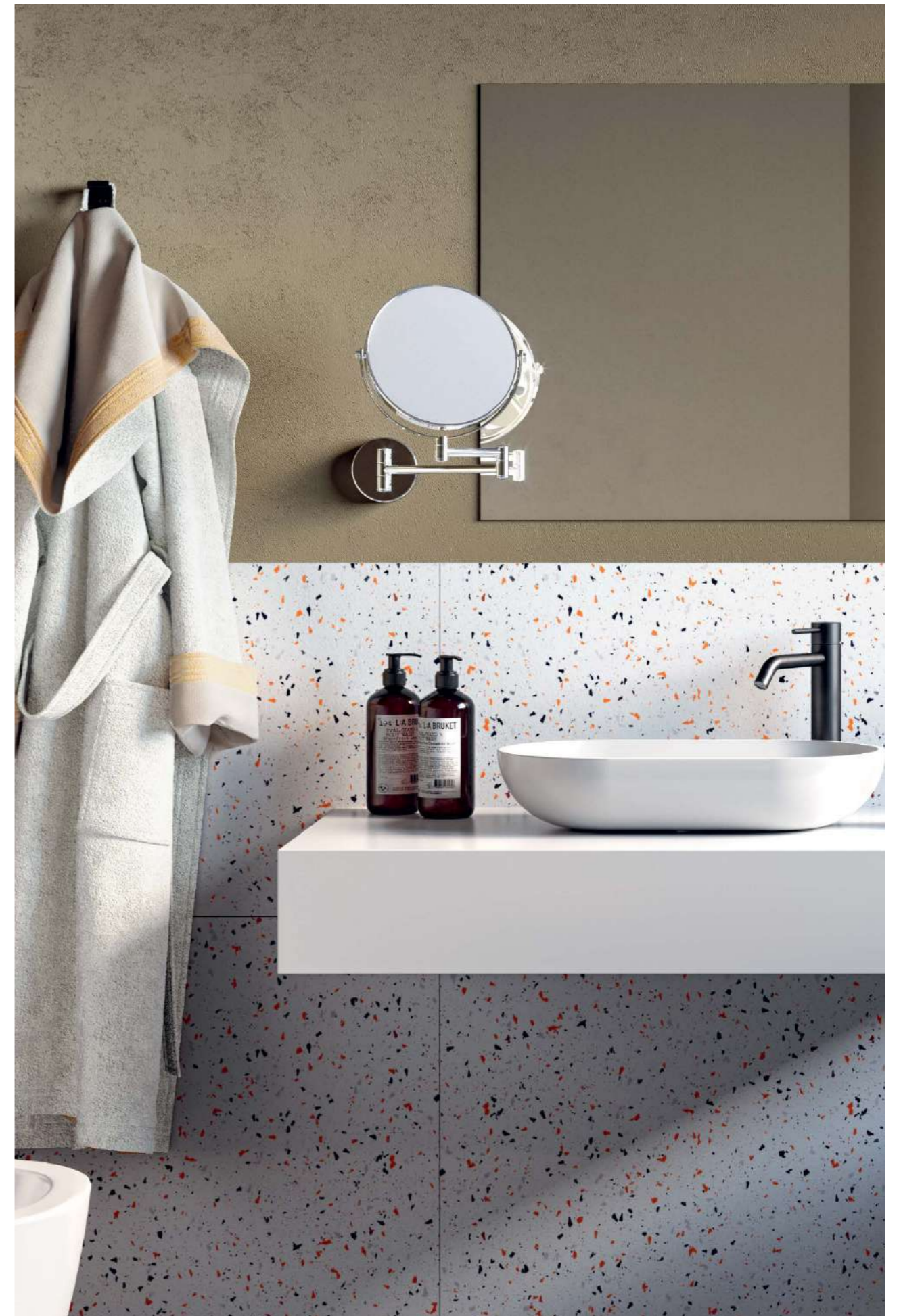

**acessórios**  
accessories



**ITALBOX®**

# TOALHEIRO ELECTRICO SH304 - 1015



12 peças de tubos aquecidos;  
 Aquecimento de frequência inteligente/variável;  
 Aquecimento temporizado (1-8horas);  
 Aquecimento termostático (45/50/55/60/65/70 C°)  
 Tensão: de acordo com a exigência do mercado;  
 Frequência: 50/60HZ;  
 Potência: 240W;  
 Fios de ligação: a partir do fundo esquerdo;  
 Instalação: Montagem na parede ou encastrada.

12 pcs of heated tubes;  
 Intelligent/variable frequency heating;  
 Timing heating (1 - 8 hours);  
 Thermostatic heating (45/50/55/60/65/70 C°)  
 Voltage: according to the market requirement;  
 Frequency: 50/60HZ;  
 Power: 240W;  
 Wiring: from left bottom;  
 Installation: Wall mounted or recessed.

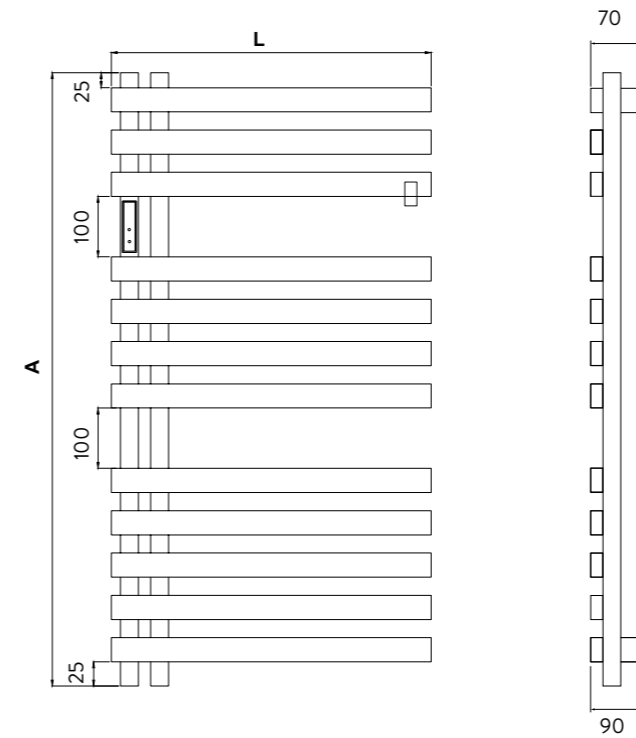

	Referências Reference	Dimensões L x A x P (mm) Dimensions L x A x P (mm)	Preço Price
Cromado Chromed	0M08-067C01	530 x 1015 x 90	<b>375 €</b>
Preto Black	0M08-067P03	530 x 1015 x 90	

# TOALHEIRO ELECTRICO SH304 - 740

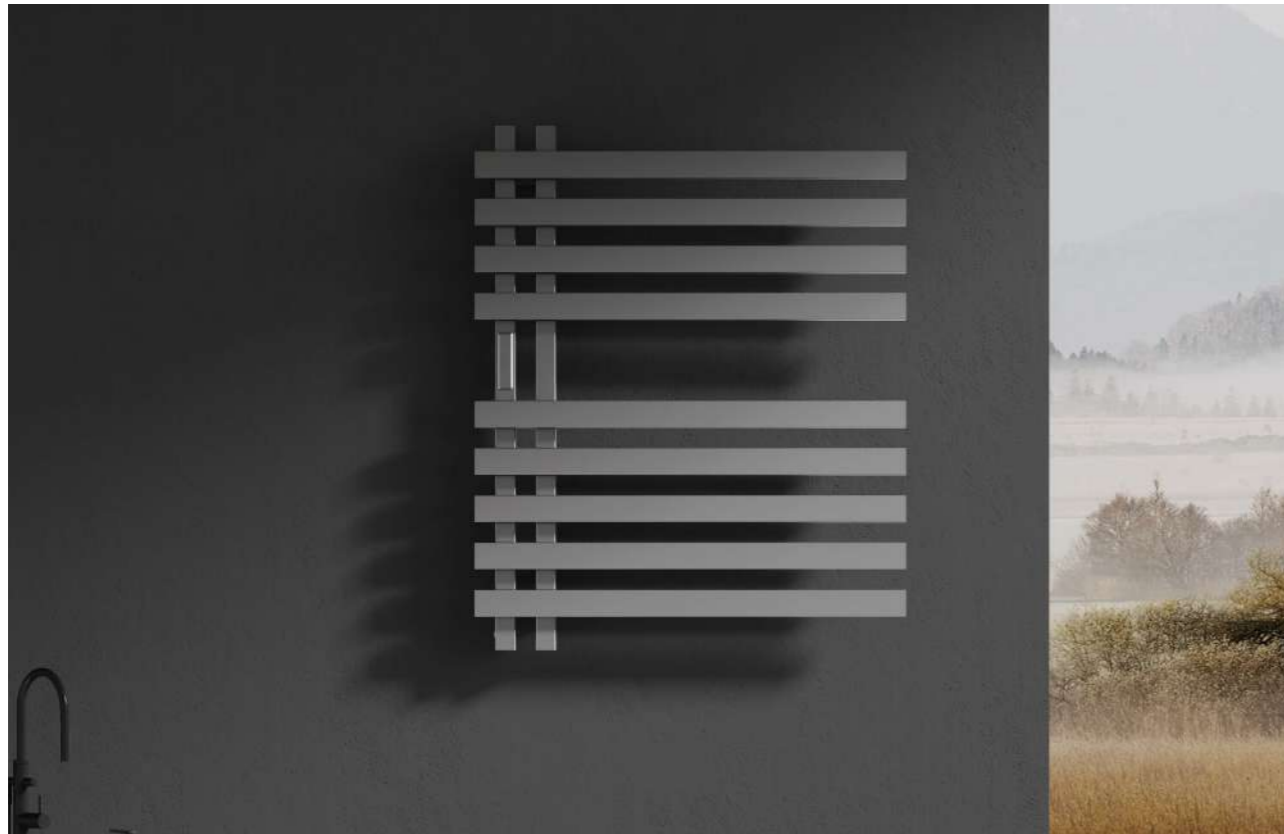
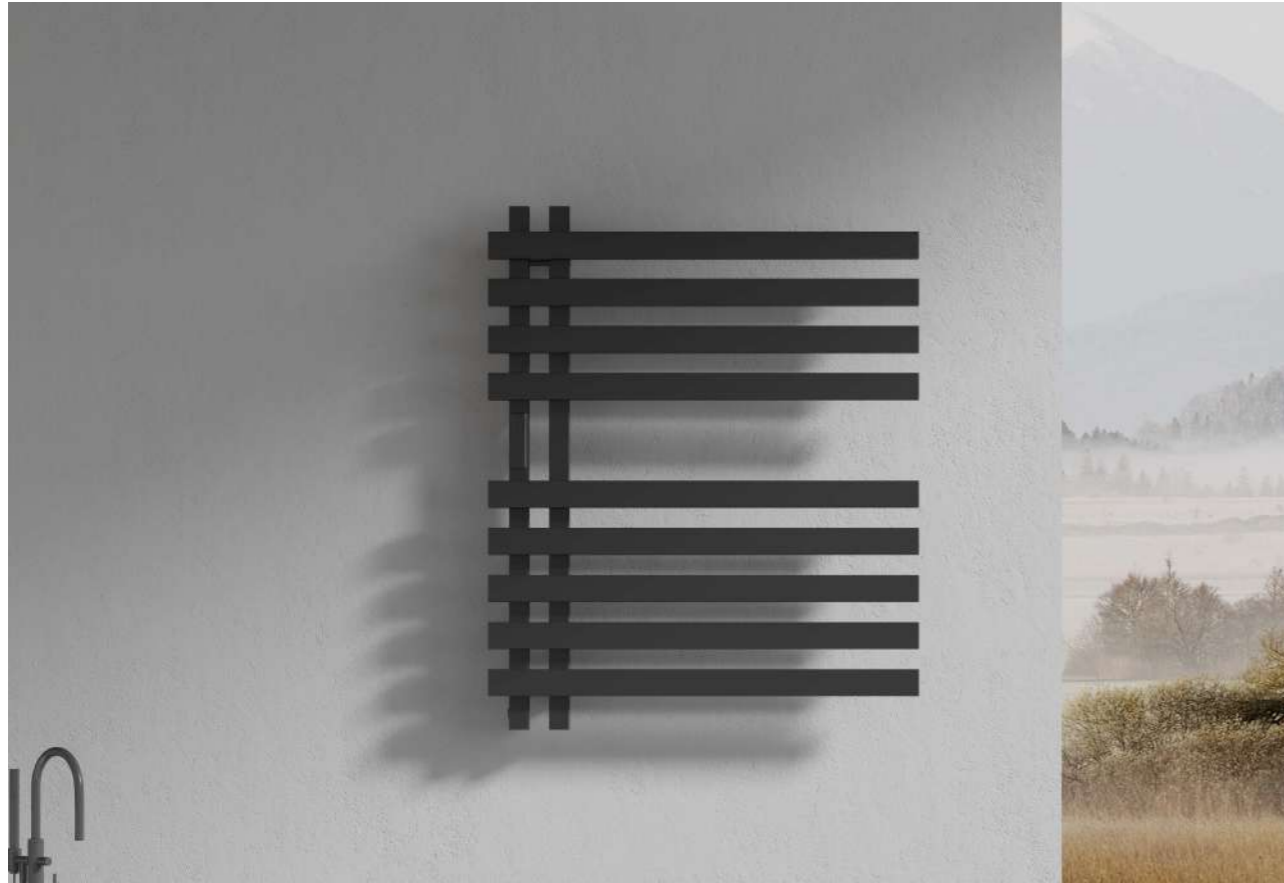

12 peças de tubos aquecidos;  
 Aquecimento de frequência inteligente/variável;  
 Aquecimento temporizado (1-8horas);  
 Aquecimento termostático (45/50/55/60/65/70 C°)  
 Tensão: de acordo com a exigência do mercado;  
 Frequência: 50/60HZ;  
 Potência: 240W;  
 Fios de ligação: a partir do fundo esquerdo;  
 Instalação: Montagem na parede ou encastrada.

12 pcs of heated tubes;  
 Intelligent/variable frequency heating;  
 Timing heating (1 - 8 hours);  
 Thermostatic heating (45/50/55/60/65/70 C°)  
 Voltage: according to the market requirement;  
 Frequency: 50/60HZ;  
 Power: 240W;  
 Wiring: from left bottom;  
 Installation: Wall mounted or recessed.

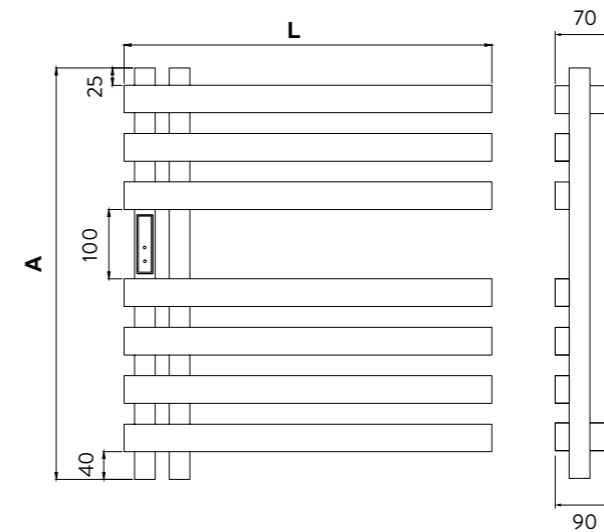

	Referências Reference	Dimensões L x A x P (mm) Dimensions L x A x P (mm)	Preço Price
Cromado Chromed	0M08-066C01	530 x 740 x 90	285 €
Preto Black	0M08-066P03	530 x 740x 90	

## Prateleira toalhas Z . Towel shelf Z

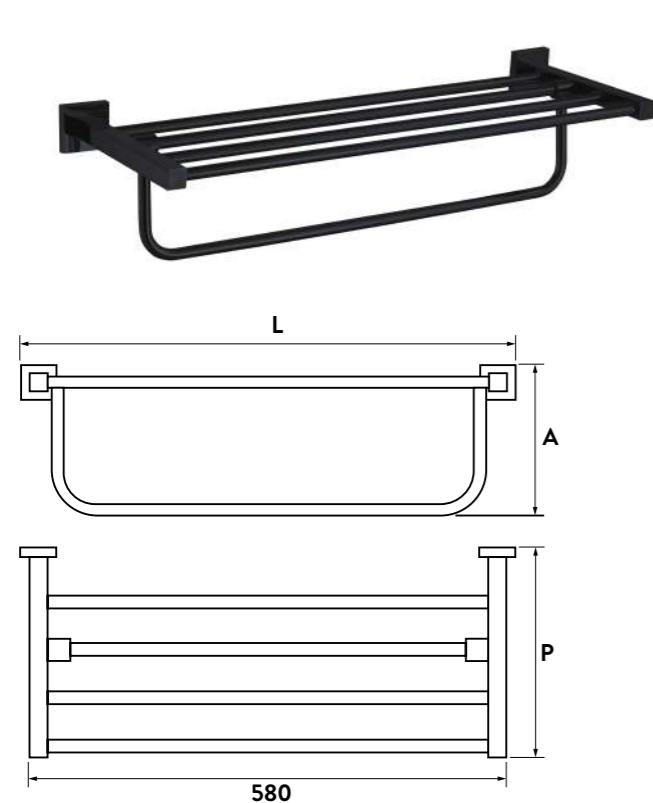

Dimensões L x A x P (mm) Dimensions L x A x P (mm)	Cromado Chromed	PVD preto mate PVD matt black
606 x 150 x 210		<b>45€</b>

## Toalheiro pequeno Z . Small towel bar Z

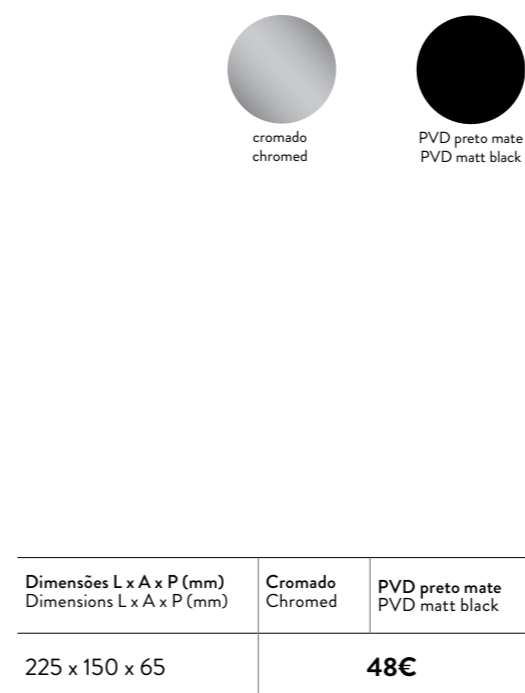

Dimensões L x A x P (mm) Dimensions L x A x P (mm)	Cromado Chromed	PVD preto mate PVD matt black
225 x 150 x 65		<b>48€</b>

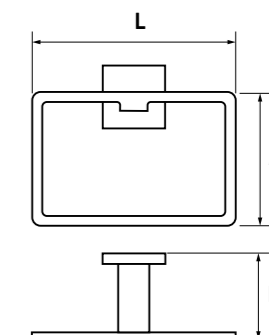
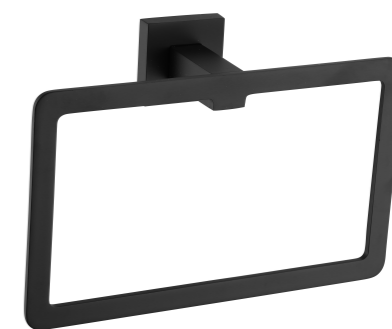

## Toalheiro Z . Towel bar Z

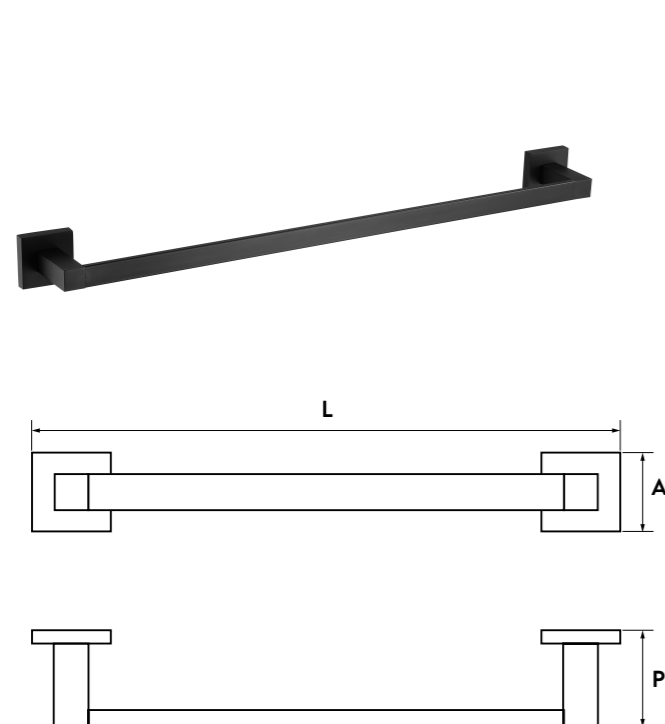

Dimensões L x A x P (mm) Dimensions L x A x P (mm)	Cromado Chromed	PVD preto mate PVD matt black
600 x 48 x 70		<b>18€</b>

## Suporte papel Z . Paper holder Z

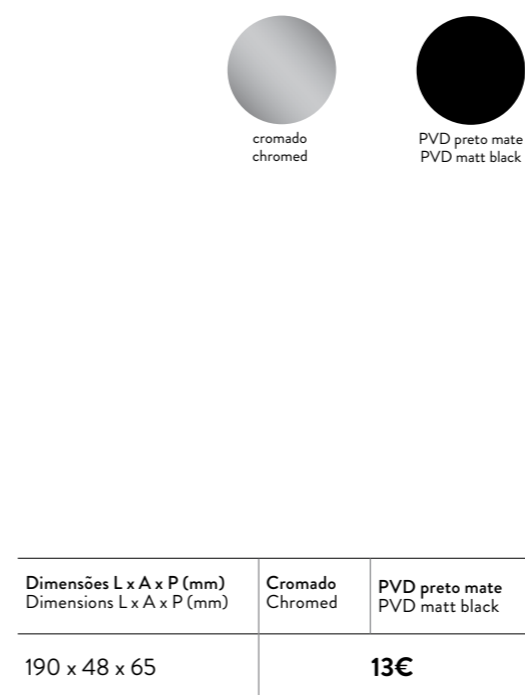

Dimensões L x A x P (mm) Dimensions L x A x P (mm)	Cromado Chromed	PVD preto mate PVD matt black
190 x 48 x 65		<b>13€</b>

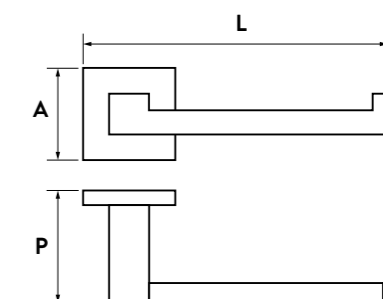
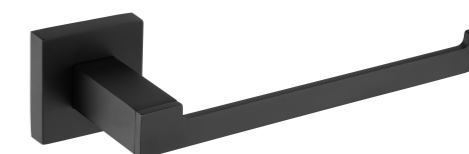

## Cabide Z . Robe hook Z



cromado  
chromed

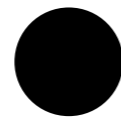

PVD preto mate  
PVD matt black

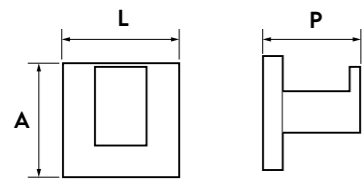

Dimensões L x A x P (mm) Dimensions L x A x P (mm)	Cromado Chromed	PVD preto mate PVD matt black
48 x 48 x 50		<b>8€</b>

## Toalheiro SS . Towel bar SS



PVD gun metal

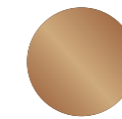

PVD rose gold escovado  
PVD brushed rose gold



PVD escovado dourado  
PVD brushed gold



PVD			
Dimensões L x A x P (mm) Dimensions L x A x P (mm)	gun metal	rose gold escovado brushed rose gold	gold escovado brushed gold
600 x 55 x 77			<b>38€</b>

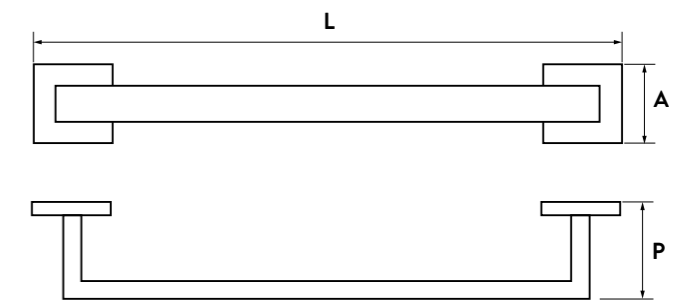

## Prateleira toalhas SS . Towel shelf SS



PVD gun metal

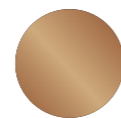

PVD rose gold escovado  
PVD brushed rose gold



PVD escovado dourado  
PVD brushed gold

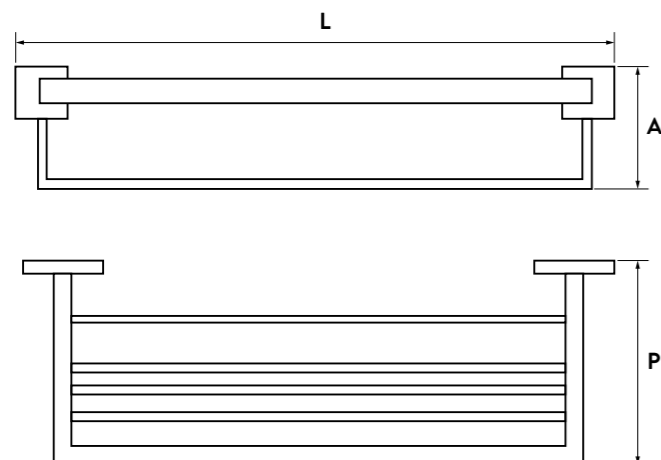

PVD			
Dimensões L x A x P (mm) Dimensions L x A x P (mm)	gun metal	rose gold escovado brushed rose gold	gold escovado brushed gold
600 x 125 x 215			<b>74€</b>

## Toalheiro pequeno SS . Small towel bar SS



PVD gun metal

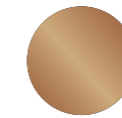

PVD rose gold escovado  
PVD brushed rose gold



PVD escovado dourado  
PVD brushed gold



PVD			
Dimensões L x A (mm) Dimensions L x A (mm)	gun metal	rose gold escovado brushed rose gold	gold escovado brushed gold
275 x 55 x 77			<b>23€</b>

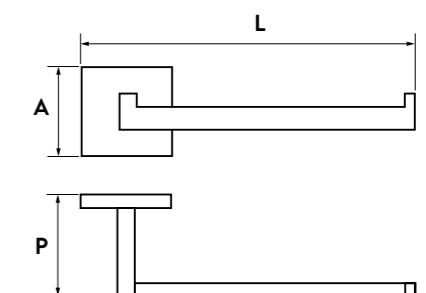

## Suporte papel SS . Paper holder SS

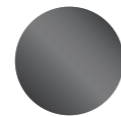

PVD gun metal

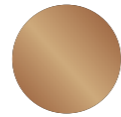

PVD rose gold escovado  
PVD brushed rose gold



PVD escovado dourado  
PVD brushed gold

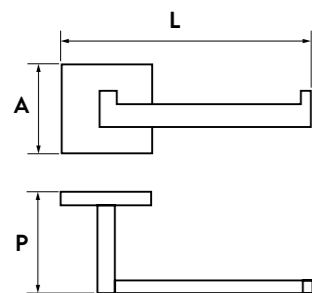

PVD			
Dimensões L x A x P (mm) Dimensions L x A x P (mm)	gun metal	rose gold escovado brushed rose gold	gold escovado brushed gold
165 x 55 x 77	<b>22€</b>		

## Piaçaba chão . Floor Toilet brush



PVD gun ash

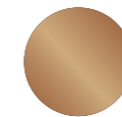

PVD rose gold escovado  
PVD brushed rose gold



PVD escovado dourado  
PVD brushed gold



cromado  
chromed



PVD preto mate  
PVD matt black

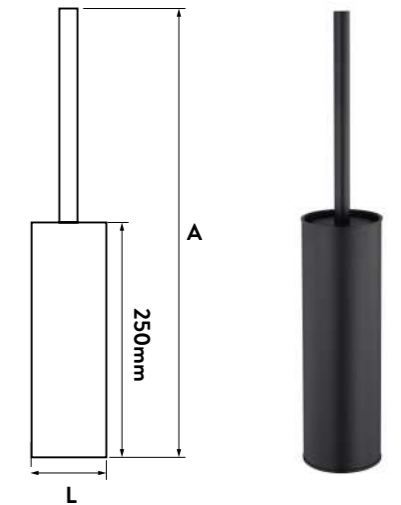

PVD					
Dimensões L x A (mm) Dimensions L x A (mm)	gun metal	rose gold escovado brushed rose gold	gold escovado brushed gold	preto mate black matt	cromado chromed
ø80 x 470	<b>30€</b>			<b>25€</b>	

## Cabide SS . Robe hook SS



PVD gun ash

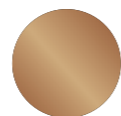

PVD rose gold escovado  
PVD brushed rose gold



PVD escovado dourado  
PVD brushed gold

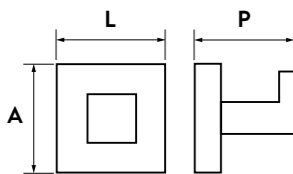

PVD			
Dimensões L x A x P (mm) Dimensions L x A x P (mm)	gun metal	rose gold escovado brushed rose gold	gold escovado brushed gold
55 x 55 x 55	<b>16€</b>		

## Piaçaba parede . Toilet brush wall mounted



PVD gun ash

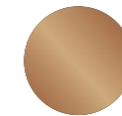

PVD rose gold escovado  
PVD brushed rose gold

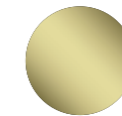

PVD escovado dourado  
PVD brushed gold

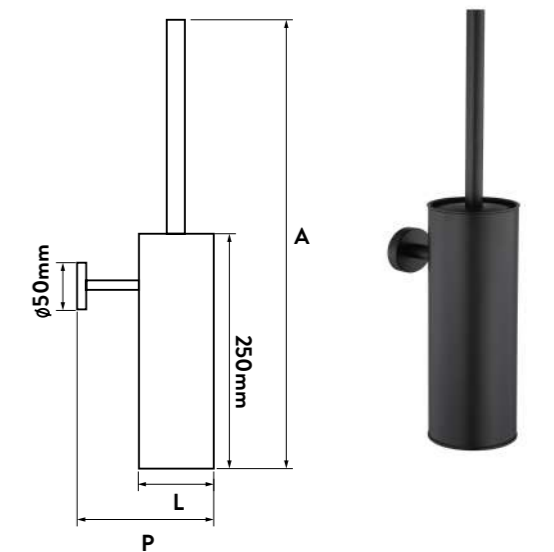

Dimensões L x A x P (mm) Dimensions L x A x P (mm)	Cromado Chromed	PVD preto mate PVD matt black
ø80 x 470 x 125	<b>30€</b>	

**informação**  
information



## Condições de venda

### 1. ORDENS DE COMPRA

- 1.1. Todas as ordens de compra são válidas mediante a confirmação escrita da Italbox, Lda. As ordens podem ser parcialmente executadas e os preços de venda, bem como as condições gerais de venda são aquelas que se tornam válidas no momento da aprovação escrita.
- 1.2. Cancelamento da ordem de compra. Nenhuma ordem de compra pode ser cancelada sem uma aprovação prévia da Italbox, Lda., a qual debitará todos os custos e despesas que possam decorrer do cancelamento.

### 2. PRAZO DE ENTREGA

- 2.1. Os prazos de entrega são meramente indicativos, não são obrigatórios e em nenhum caso podem ser utilizados para justificar atrasos de pagamento e compensação por danos. No caso do prazo de entrega seja indispensável para o comprador, este deverá especifica-lo por escrito no momento de fazer o pedido.

### 3. PREÇOS

- 3.1. Os preços que constam na tabela são válidos para entregas "Ex-Works" (Intercoms 1990), os custos de transporte vêm especificados na factura.
- 3.2. Os preços constantes na tabela não incluem IVA e podem ser alterados sem aviso prévio.

### 4. TERMOS DE PAGAMENTO

- 4.1. Os pagamentos são os que constam na factura, quando não vigorar outro tipo de acordo. Em caso de atraso total ou parcial de pagamento, a Italbox, Lda., tem direito a receber 4% de juros por mês e reserva-se o direito de suspender o fornecimento de material

### 5. EMBALAGEM

- 5.1. O preço inclui a embalagem. As caixas de madeira ou paletes, que são necessárias eventualmente para uma grande parte dos produtos mais frágeis, serão debitados no custo.

### 6. TRANSPORTE E RECLAMAÇÕES

- 6.1. Os riscos de transporte dos bens são suportados pelo comprador. O consignatário tem de verificar os bens quando eles são entregues e reclamar qualquer discrepância verificada no momento da entrega.
- 6.2. As reclamações são consideradas válidas apenas se forem comunicadas através de uma carta registada no prazo máximo de 8 dias a contar da data de entrega.

### 7. GARANTIA

- 7.1. Garantia de 3 anos contra todo o defeito de fabricação. Garantia de instalação, quando realizada pelos nossos instaladores oficiais ITALBOX.
- 7.2. A garantia não cobre deteriorações não imputáveis ao produto, ou derivados de negligência na sua manipulação.
- 7.3. A ITALBOX, Lda., tem o direito de implementar qualquer alteração nas suas condições, que seja considerada apropriada ou necessária por razões técnicas ou comerciais

### 8. CONDIÇÕES GERAIS DE VENDA

- 8.1. As condições gerais de venda são consideradas aceites no momento da ordem de compra. Sempre que for necessário será feita uma referência ao Código Civil Português. Em caso de litígio ambas as partes se submeter à jurisdição da comarca de Águeda.

### 9. ANULAÇÕES

- 9.1. Só são aceites anulações de encomendas 24 horas após a receção do email da confirmação da encomenda enviada pela ITALBOX.

### 10. DEVOLUÇÕES

- 10.1. Não se aceita nenhuma devolução que não tenha sido previamente autorizada pela ITALBOX Lda e que não chegue as nossas instalações acompanhada do documento que justifique as causas e a decisão tomada (Autorização de devolução).

## Sales conditions

### 1. PURCHASE ORDERS

- 1.1. All purchase orders are valid only following to Italbox, Lda. written approval. The orders can be partially despatched and the applicable selling prices as the applicable General Sales Conditions are the ones valid at the time of the written approval.
- 1.2. Purchase order cancellation. No purchase order can be cancelled without prior approval from Italbox, Lda., the latest is anyhow entitled to charge the expenses and the costs arising from any cancellation.

### 2. DELIVERY DEADLINE

- 2.1. The delivery deadlines for special orders are x days.
- 2.2. For standard orders are y days. Delivery deadlines agreed outsider these conditions must be specified in writing and subject to the approval of the Commercial Department.

### 3. PRICES

- 3.1. The prices quoted in the price list are not binding and are valid for "Ex-Works" (Intercoms 1990) deliveries. When the goods are sold on DDT (Intercoms 1990) terms the transport costs will be charged in the commercial invoice.
- 3.2. The prices in the price list do not includes IVA and can be modified at short notice.

### 4. PAYMENT TERMS

- 4.1. Payments are those listed in the commercial invoice, when not otherwise adreed. In case of total or partial delay payment Italbox, Lda. is entitled to charge with 4% interests per each month, and can interrupt all deliveries.

### 5. PACKAGING

- 5.1. The item prices are inclusiv of the packaging.
- 5.2. Wooden boxes or pallets, which eventually are necessary for a major goods safety in handling, will be charged at the cost.

### 6. TRANSPORT AND COMPLAINT

- 6.1. The goods transportation risks are pertaining to the buyer also in case the goods are transported by means of our own vehicles. The consignee is asked to check the goods when delivered and claim any discrepancy at the time of the delivery.
- 6.2. Claims are considered valid only when communicated by means of a registered letter within 8 working days from the date of the delivery.

### 7. GUARANTEE

- 7.1. The shower enclosures and the pertinent accessories are guaranteed for 3 years.
- 7.2. Italbox, Lda. is entitled to implement any change two its own items, which will be evaluated appropriate or necessary for technical and/or commercial reasons.

### 8. GENERAL SALES CONDITIONS

- 8.1. The general sales conditions are considered fully accept following to the purchase order issue. When the context otherwise requires reference is made to the Portugal Civil Code. For any dispute, controversy or claim arising out of relating to these sales conditions shall be finally settled by the competent Court in Águeda (Portugal).

### 9. ANULATIONS

- 9.1. Anulations of orders only are accepted 24 hours after the receipt of the email of the order confirmation sent by ITALBOX.

### 10. DEVOLUTIONS

- 10.1. We do not accept any devolution that have not been previously authorized by Italbox, Lda or does not have any document justifying the causes and the decison ( Devolution Authorization).



**ITALBOX<sup>®</sup>**

