



2026

MARGRES
CERAMIC TILES



MACOLIDE

revestimento, cozinha e banho



CONFORTO EM MINHA CASA

+351 211 633 633

www.macolide.pt | info@macolide.pt

index

— index . index . índice

collections

bare&bold	P. 25
concept	P. 189
deck plus	P. 85
endless	P. 125
evoke	P. 169
evolution	P. 57
fragment	P. 43
grove	P. 201
hybrid	P. 157
metropolis	P. 93
prestige	P. 179
pure stone	P. 137
slabstone	P. 223
stage	P. 111
subway	P. 233
tecnic	P. 255
thunder	P. 73
time 2.0	P. 241
tool	P. 211

linea collections

cosmos	P. 297
endless	P. 275
evolution	P. 267
prestige	P. 309
pure stone	P. 289
slabstone	P. 313
subway	P. 317
time 2.0	P. 325
tool	P. 301

useful information

calibers	P. 365
certification	P. 340
colour map	P. 8
general sales conditions	P. 368
important notes	P. 375
laying suggestions	P. 367
margres tools	P. 332
outdoor extra thick	P. 348
package	P. 364
pr()tect	P. 334
sustainable choice	P. 336
symbols	P. 366
technical information	P. 352

sizes' index

— index formats . index formate . índice formatos —

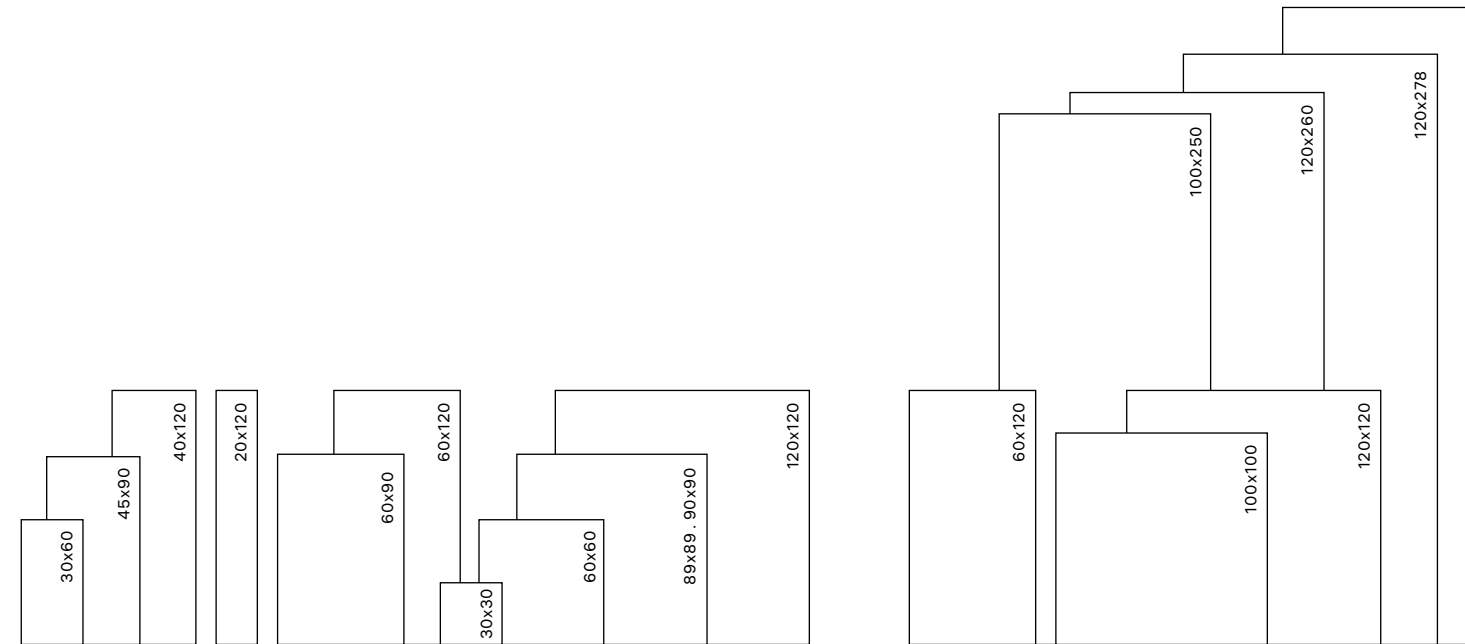

		LINEA																	
		20x120	30x30	30x60	40x120	45x90	60x60	60x90	60x120	89x89	90x90	120x120	60x120	100x100	100x250	100x300	120x120	120x260	120x278
bare&bold	P. 25	■			■														
concept	P. 189			■		■	■		■		■								
cosmos	P. 297													■		■			
deck plus	P. 85	■			■														
endless	P. 125								■	■	■			■	■	■			
evoke	P. 169			■			■				■								
evolution	P. 57			■			■		■		■						■		■
fragment	P. 43						■		■		■								
grove	P. 201	■			■														
hybrid	P. 157			■			■		■		■								
metropolis	P. 93			■			■		■		■								
prestige	P. 179						■		■	■	■		■	■	■				
pure stone	P. 137			■			■		■		■		■	■	■				
slabstone	P. 223					■	■				■		■	■	■				
stage	P. 111	■							■										
subway	P. 233						■				■		■		■				
tecnic	P. 255		■																
thunder	P. 73			■			■	■	■		■								
time 2.0	P. 241			■			■		■		■		■	■	■				
tool	P. 211					■	■				■		■			■	■		

index

anti-slip's

finishes

sizes

sizes + finishes
+ thickness

thickness

colour map

collections

linea collections

useful information

Tabela Preços



finishes' index

— index finitions . index oberfläche . índice acabamentos

	A	AS	ASR	ASR FLAT	E	E ASR	ENR	N	NR	SM	P	TC	W
bare&bold P. 25			■			■			■				
concept P. 189	■		■						■				
cosmos P. 297									■				
deck plus P. 85		■				■							
endless P. 125			■							■	■		
evoke P. 169			■			■			■			■	
evolution P. 57	■		■			■			■				
fragment P. 43									■				
grove P. 201		■				■		■					
hybrid P. 157			■						■				
metropolis P. 93	■		■						■			■	
prestige P. 179			■						■		■		
pure stone P. 137	■		■	■		■			■				
slabstone P. 223	■		■			■			■				
stage P. 111	■								■				
subway P. 233	■					■			■				
tecnica P. 255		■			■			■					■
thunder P. 73			■			■			■				
time 2.0 P. 241			■				■		■		■		
tool P. 211	■		■			■			■			■	

reference finishing

— référence
— referenz
— referência

— finition
— oberfläche
— acabamento

A*	soft shiny . adouci . halbpoliert . amaciado
AS	anti-slip . antidérapant . rutschfest . antiderrapante
ASR	anti-slip rectified . antidérapant rectifié . rutschfest rektifiziert . antiderrapante retificado
ASR FLAT	anti-slip rectified . antidérapant rectifié . rutschfest rektifiziert . antiderrapante retificado
E	extra thick . forte épaisseur . überdicke fliese . espessurado
E ASR*	extra thick anti-slip . forte épaisseur antidérapant . rutschfestig überdicke fliese . espessurado antiderrapante
E NR	extra thick nat. rectified . forte épaisseur nat. rectifié . nat. rektifiziert überdicke fliese . espessurado nat. retificado
N	natural . naturel . naturbelassen . natural
NR	nat. rectified . nat. rectifié . nat. rektifiziert . nat. retificado
SM*	smooth
P*	polished . poli . poliert . polido
TC*	touch
W	wavy . ondulé . wellig . ondulado

* always rectified . toujours rectifié . immer rektifiziert . sempre retificado

MARGRES
CERAMIC TILES

thickness' index

— index épaisseurs . index stärke . índice espessuras

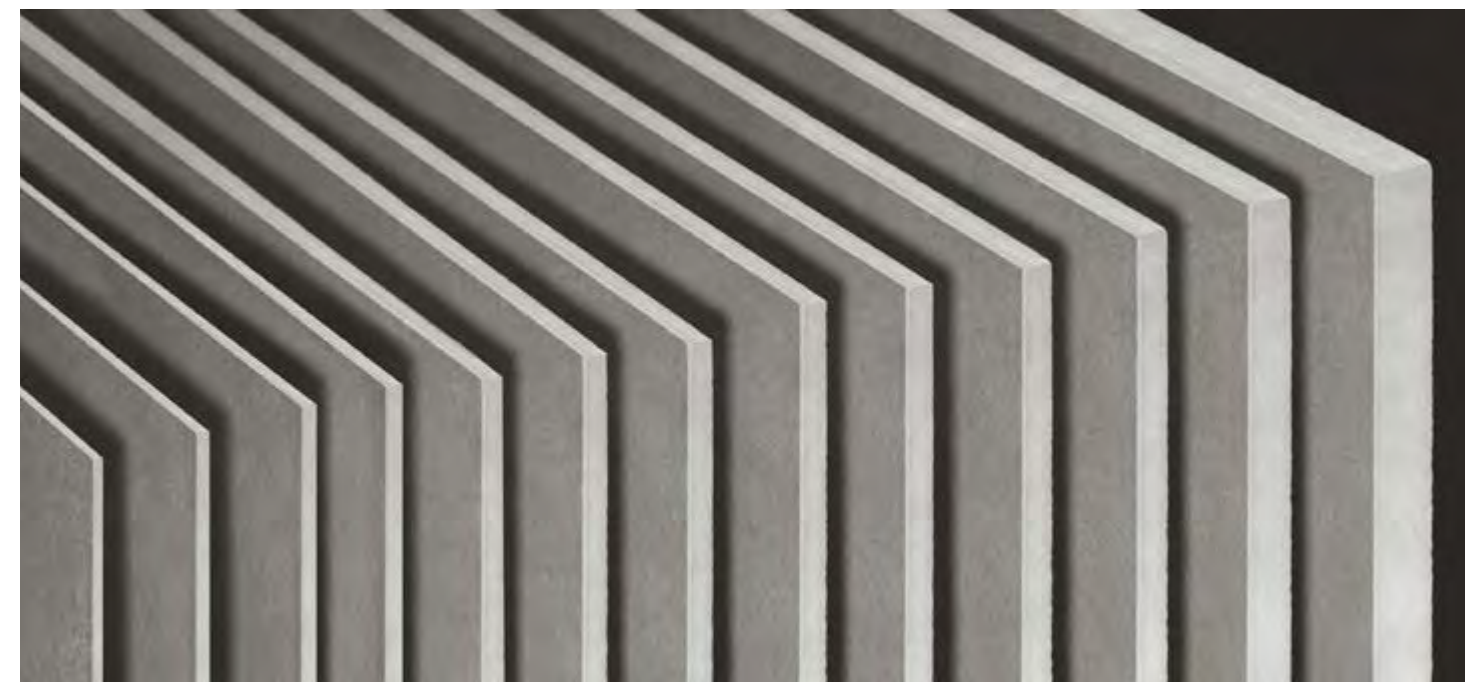

3,5mm 5,5mm 6mm 8mm 8,5mm 9mm 9,5mm 10mm 10,5mm 11mm 12mm 14mm 20mm

		LINEA													
		3,5mm	5,5mm	6mm	8mm	8,5mm	9mm	9,5mm	10mm	10,5mm	11mm	12mm	14mm	20mm	
bare&bold P. 25															■
concept P. 189							■	■	■						
cosmos P. 297		■													
deck plus P. 85									■						■
endless P. 125			■								■				
evoke P. 169								■		■					■
evolution P. 57				■			■	■	■						■
fragment P. 43								■		■					
grove P. 201							■								■
hybrid P. 157											■		■		
metropolis P. 93									■	■	■				
prestige P. 179			■					■		■					
pure stone P. 137				■				■	■	■					■
slabstone P. 223		■						■	■	■					■
stage P. 111											■				
subway P. 233		■							■		■				■
tecnica P. 255									■				■		
thunder P. 73									■		■				■
time 2.0 P. 241		■								■	■	■	■		■
tool P. 211				■					■	■	■				■

index

anti-slip's

finishes

sizes

sizes + finishes
+ thickness

thickness

colour map

collections

linea collections

useful information

Tabela Preços



sizes' + finishes' + thickness' index

— index formats + finitions + épaisseurs . index formate + oberfläche + stärken . índice formatos + acabamentos + espessuras

		20x120	30x30	30x60	40x120	45x90	60x60	60x90	60x120	89x89	90x90	100x100	100x250	100x300	120x120	120x260	120x278
bare&bold P. 25		NR ASR 9,5mm			E ASR 20mm												
concept P. 189				NR . A 8,5mm		NR . A ASR 9mm	NR . A ASR 8,5mm		NR . A 9,5mm		NR . A 9,5mm					NR 9mm	
cosmos P. 297												NR 3,5mm		NR 3,5mm			
deck plus P. 85		AS 9mm			E ASR 20mm												
endless P. 125									SM . P 9,5mm	P 9,5mm	SM ASR 9,5mm	SM . P 5,5mm	SM . P 5,5mm	SM . P 5,5mm			
evoke P. 169				NR 8,5mm			NR . TC ASR 8,5mm		NR . TC 9,5mm E ASR 20mm		NR . TC 9,5mm E ASR 20mm						
evolution P. 57				NR 8,5mm			NR . A ASR 8,5mm		NR . A 9,5mm		NR . A ASR 9,5mm E ASR 20mm				A 6mm NR 9,0mm		A 6mm
fragment P. 43							NR 8,5mm		NR 9,5mm		NR 9,5mm						
grove P. 201		N . AS 8mm			E ASR 20mm												
hybrid P. 157				NR ASR 10mm			NR ASR 10mm		NR ASR 11mm		NR ASR 11mm						
metropolis P. 93				NR 8,5mm			NR . TC ASR 8,5mm		NR . TC A . ASR 9,5mm		NR . TC A . ASR 9,5mm				NR 9mm		
prestige P. 179							NR . P 8,5mm		NR . P 9,5mm	P 9,5mm	NR 9,5mm	NR . P ASR 5,5mm	NR . P 5,5mm	NR . P 5,5mm			
pure stone P. 137				NR . A 8,5mm			NR . A ASR 8,5mm		NR . A ASR 9,5mm E ASR 20mm		NR . A ASR 9,5mm	NR 6mm	NR 6mm	NR 6mm	NR . A 9mm		
slabstone P. 223						NR 9mm	NR . A ASR 8,5mm E ASR 20mm				NR ASR 9,5mm	NR 3,5mm			NR 3,5mm		
stage P. 111		NR . A 9,5mm							A 9,5mm								
subway P. 233							NR . A 8,5mm E ASR 20mm				NR 9,5mm	NR 3,5mm			NR 3,5mm		
tecnica P. 255			N . W AS 8,5mm E 12mm						NR . A 8,5mm E ASR 20mm								
thunder P. 73				NR 8,5mm			NR 8,5mm E ASR 20mm	E ASR 20mm	NR 9,5mm		NR ASR 9,5mm						
time 2.0 P. 241				NR 10mm P 9,5mm			NR ASR 10mm P 9,5mm E NR 14mm		NR 11mm P 10,5mm		NR 11mm P 10,5mm	NR 3,5mm			NR 3,5mm		
tool P. 211						NR . A 9mm	NR . TC A 8,5mm E ASR 20mm		NR 6mm		NR . A ASR 9,5mm				NR 6mm	NR 6mm	

anti-slip's index

— index glissement . index rutschen . índice escorregamento

	DIN EN 16165 Annex B			DIN EN 16165 Annex A			DIN EN 16165 Annex C	AS/NZS 4586			ENV 12633 Class		
	R11	R10	R9	C	B	A	≥ 36	P5	P4	P3	3	2	1
bare&bold P. 25	ASR E ASR	NR		ASR E ASR	NR		NR ASR E ASR		ASR E ASR		ASR E ASR		
concept P. 189	ASR	NR		ASR	NR		NR . ASR			NR	ASR	NR	
cosmos P. 297		linea NR											
deck plus P. 85	AS E ASR			AS E ASR			AS E ASR		AS E ASR		AS E ASR		
endless P. 125		ASR			ASR		ASR			ASR			
evoke P. 169	ASR E ASR	NR		ASR E ASR	NR		NR ASR E ASR		ASR E ASR	NR			
evolution P. 57	ASR E ASR	NR		ASR E ASR	NR		NR ASR E ASR		ASR E ASR	NR	ASR E ASR	NR	
fragment P. 43			NR			NR	NR			NR			NR
grove P. 201	AS E ASR	N		AS E ASR	N		N . AS E ASR		E ASR				
hybrid P. 157	ASR	NR		ASR	NR		NR ASR	ASR	NR		NR ASR		
metropolis P. 93	ASR	NR		ASR	NR		NR ASR		ASR	NR	ASR	NR	
prestige P. 179		linea ASR											
pure stone P. 137	ASR ASR FLAT E ASR	NR linea forge	linea NR	ASR ASR FLAT E ASR	NR		NR . ASR ASR FLAT E ASR		ASR ASR FLAT E ASR	NR	ASR ASR FLAT		
slabstone P. 223	ASR E ASR	NR	linea NR	ASR E ASR	NR		NR ASR E ASR		E ASR		ASR		
stage P. 111		NR			NR		NR		NR		NR		
subway P. 233		E ASR	NR linea NR		E ASR	NR	E ASR			NR			
tecnica P. 255	AS	W	N . E	AS . W			N . AS . W				AS . W		
thunder P. 73	ASR E ASR	NR		ASR E ASR	NR		NR ASR E ASR		ASR E ASR	NR	ASR E ASR	NR	
time 2.0 P. 241	ASR	NR ENR	linea NR	ASR	NR ENR		NR ENR ASR			NR	ASR	NR ENR	
tool P. 211	ASR E ASR	NR	linea NR	ASR E ASR		NR	NR ASR E ASR			NR			

index

anti-slip's

finishes

sizes

sizes + finishes + thickness

thickness

colour map

collections

linea collections

useful information

Tabela Preços



colour map

— wood look

scale 1:3

bare cream BB1 P. 38

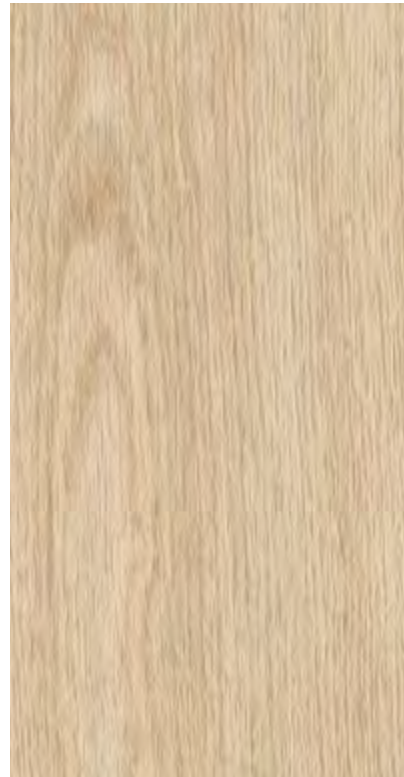

bold cream BB4 P. 39



stage cream SE1 P. 120



stage beige SE2 P. 120



grove beige GR2 P. 208



grove light brown GR5 P. 209

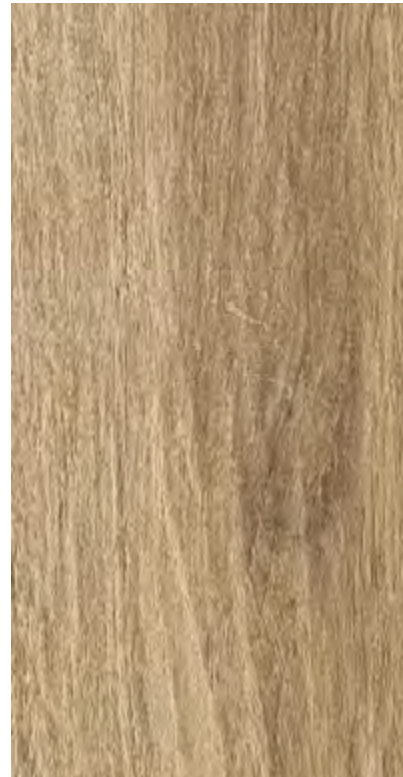

grove brown GR6 P. 209



stage cherry SE4 P. 121

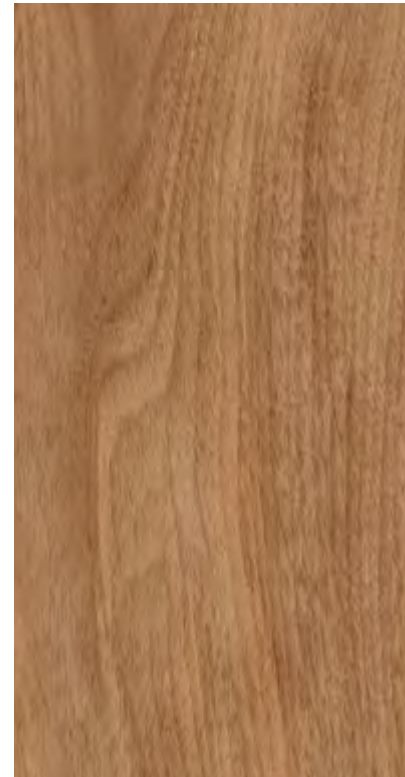

bare beige BB2 P. 38

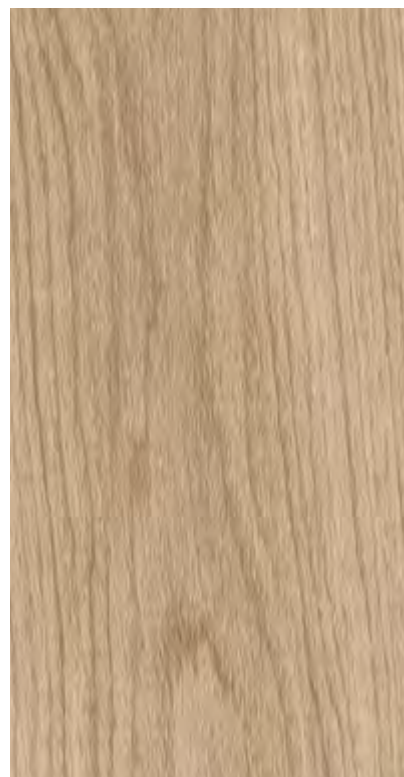

bold beige BB5 P. 39



bare dark beige BB3 P. 38



bold dark beige BB6 P. 39



stage brown SE5 P. 121

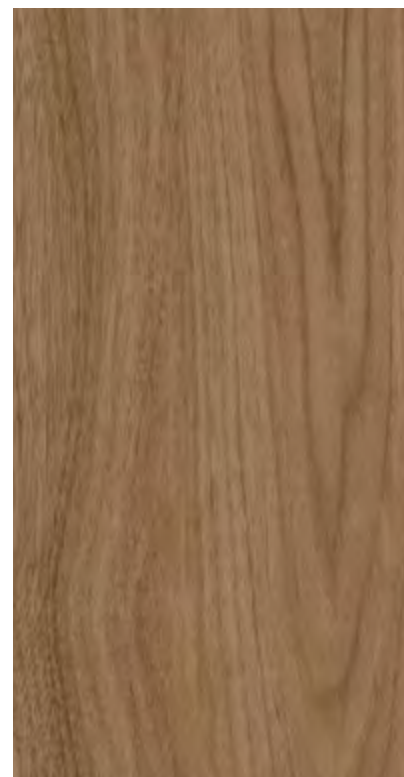

deck plus light brown DP2 P. 91



deck plus wenge DP3 P. 91



colour map

— wood look

1 / 2 ▶

index

colour map

chromatic look

concrete look

marble look

stone look

wood look

collections

linea collections

useful information

Tabela Preços



colour map

— wood look

◀ 1 / 2

scale 1:3

grove white GR1 P. 208



grove tortora GR4 P. 209



grove grey GR3 P. 208



deck plus light grey DP1 P. 91



colour map

— stone look

1 / 2 / 3 ▶

slabstone white SL1 P. 228

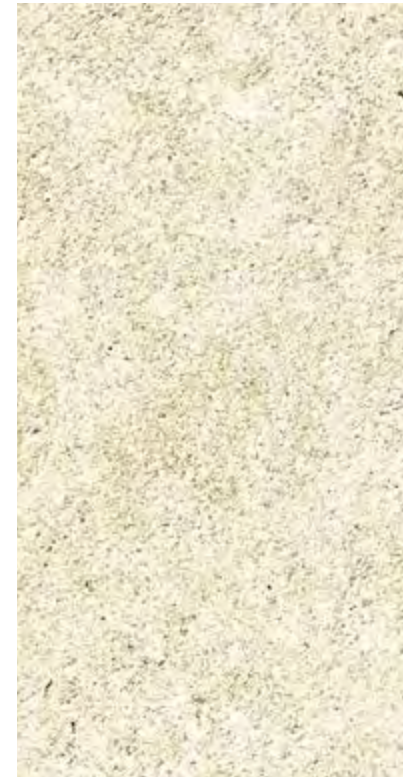

evolution white EN1 P. 66

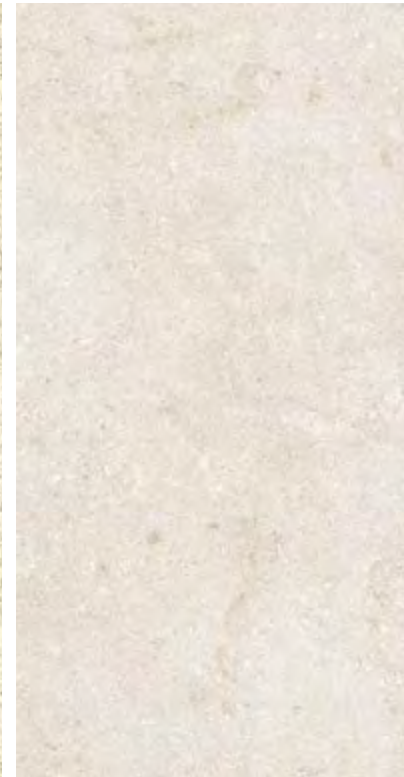

concept white CT1 P. 196

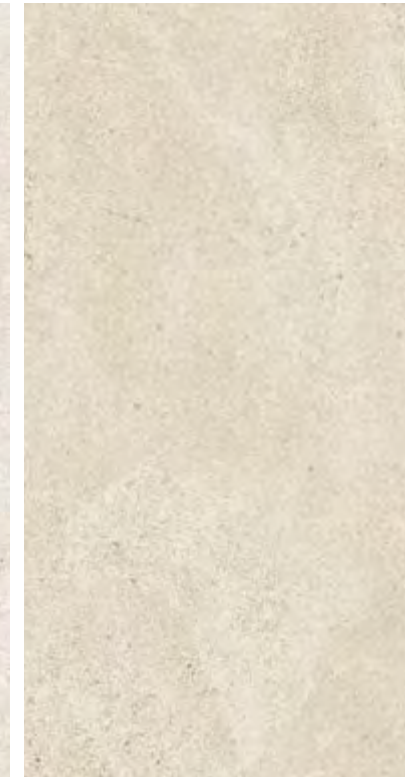

pure stone white PS1 P. 150



slabstone beige SL2 P. 228



concept beige CT2 P. 196



pure stone beige PS2 P. 150

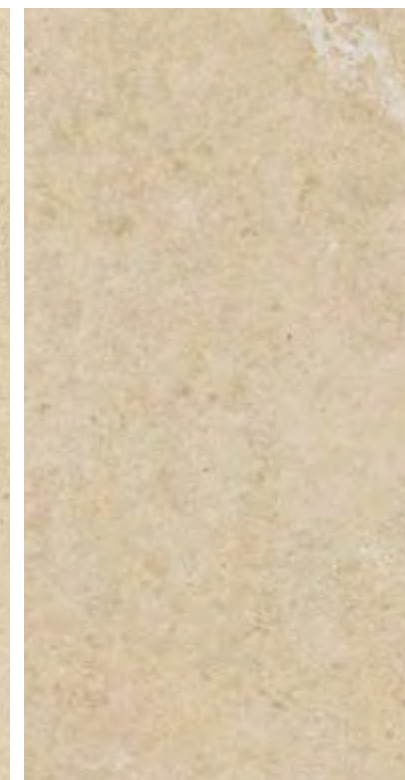

tecnica granito preto 75 P. 256



index

colour map

chromatic look

concrete look

marble look

stone look

wood look

collections

linea collections

useful information

Tabela Preços



colour map

— stone look

◀ 1 / 2 / 3

scale 1:3

tecnica branco 44 P. 256



hybrid white HB1 P. 164

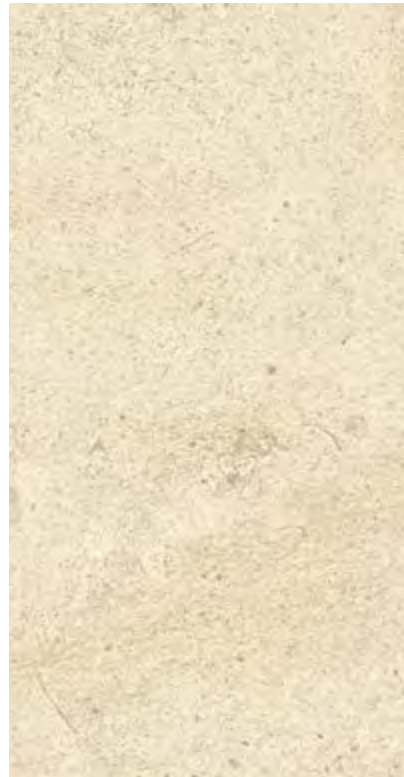

thunder beige TH1 P. 80

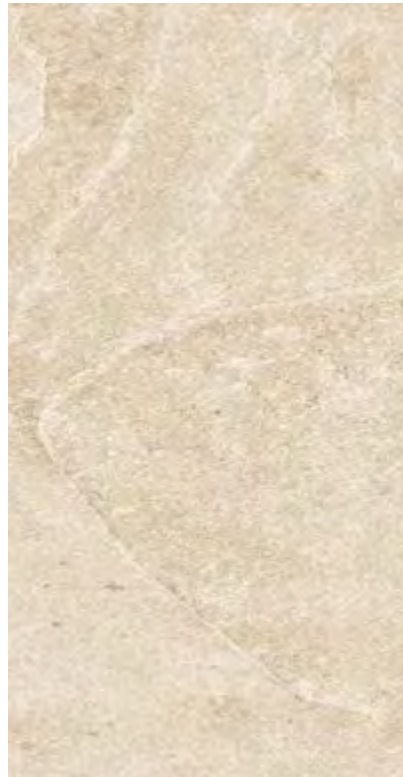

evolution beige EN2 P. 66

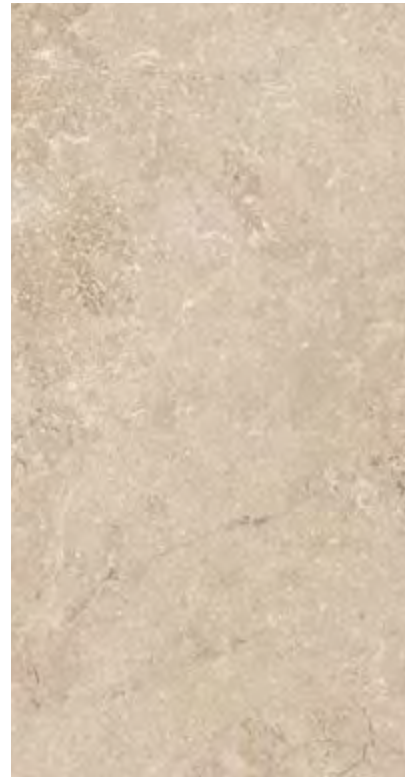

pure stone light grey PS3 P. 150

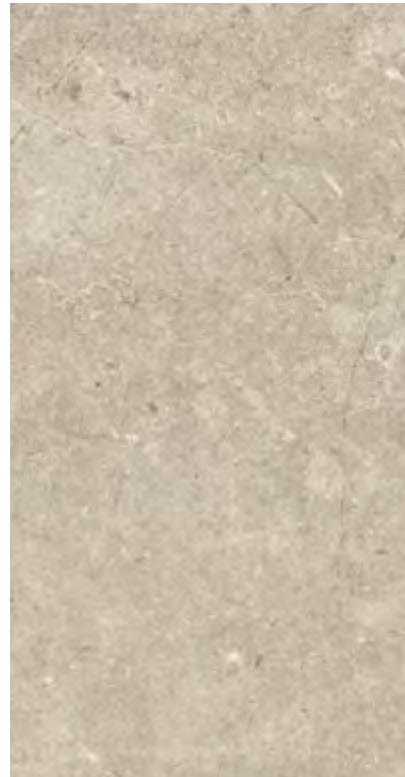

concept light grey CT3 P. 197



thunder light grey TH2 P. 80



evolution light grey EN3 P. 67



hybrid beige HB2 P. 164



tecnica granito beige 33 P. 256



slabstone tortora SL3 P. 228



hybrid tortora HB4 P. 165



concept grey CT4 P. 197



tecnica granito cinza 36 P. 256



thunder anthracite TH3 P. 81

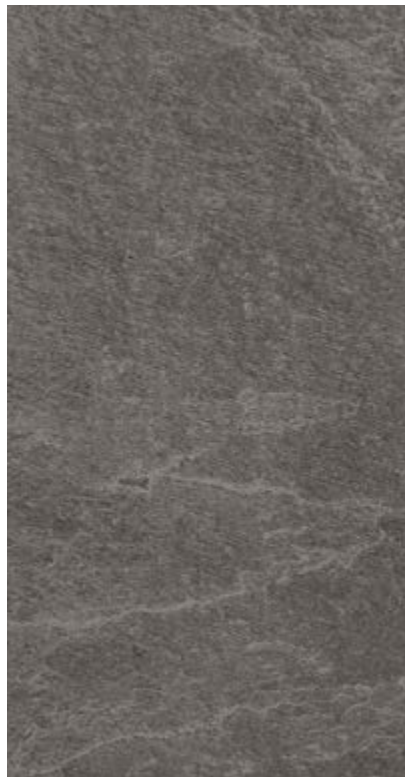

thunder rust TH4 P. 81



colour map

stone look —

1 / 2 / 3 ▶

index

colour map

chromatic look

concrete look

marble look

stone look

wood look

collections

linea collections

useful information

Tabela Preços



colour map

— stone look

◀ 1 / 2 / 3

scale 1:3

hybrid light grey HB3 P. 165



slabstone light grey SL4 P. 229



tecnica platina 41 P. 256



pure stone grey PS4 P. 151



fragment white FR1 P. 52



fragment terracotta FR3 P. 52



evolution black EN4 P. 67

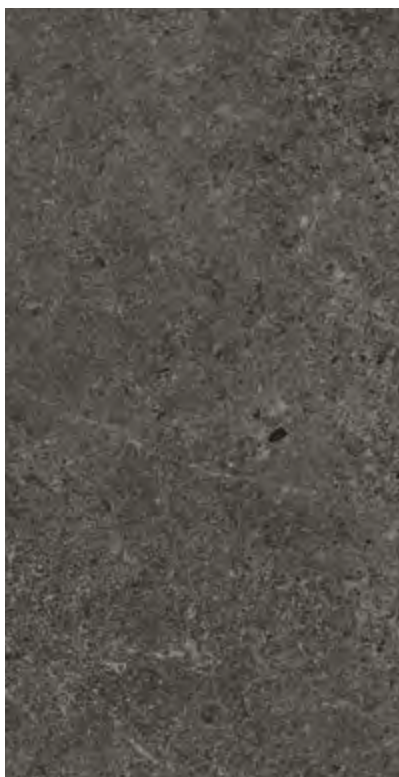

slabstone grey SL5 P. 229



hybrid black HB5 P. 165



tecnica preto 46 P. 256



fragment grey FR5 P. 52



colour map

stone look —

index

colour map

chromatic look

concrete look

marble look

stone look

wood look

collections

linea collections

useful information

Tabela Preços



colour map

— marble look

scale 1:3

prestige calacata PT1 P. 185



endless calacata gold ED1 P. 132



endless breccia capraia ED2 P. 132

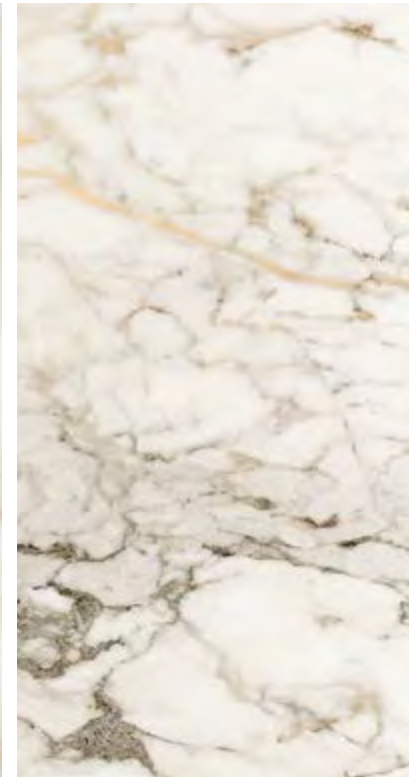

endless travertino ED3 P. 132



prestige corinthian beige PT2 P. 185

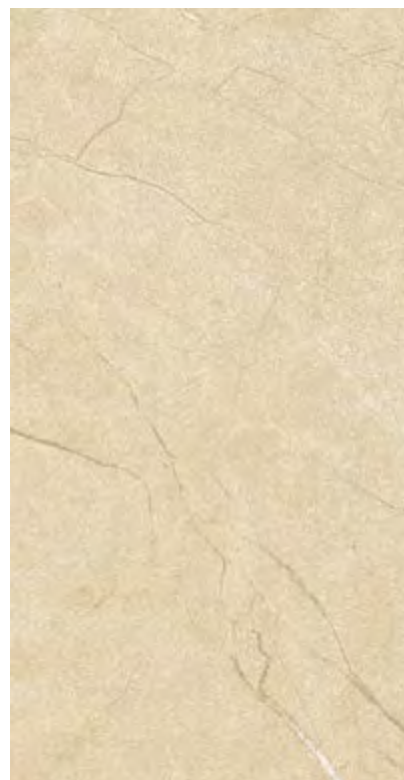

prestige fior di bosco tortora PT4 P. 185

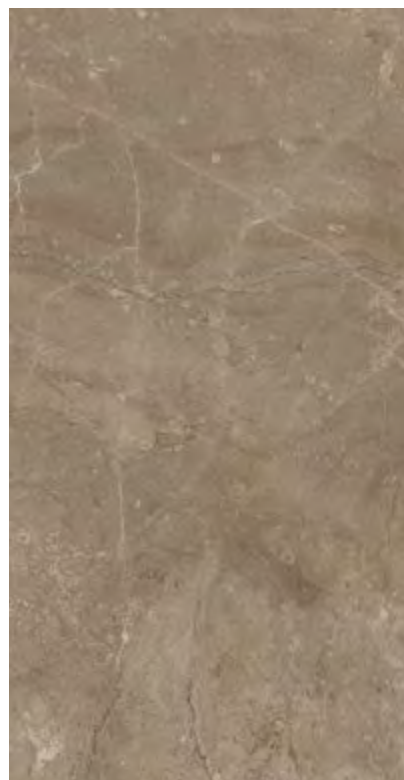

endless port black ED4 P. 133

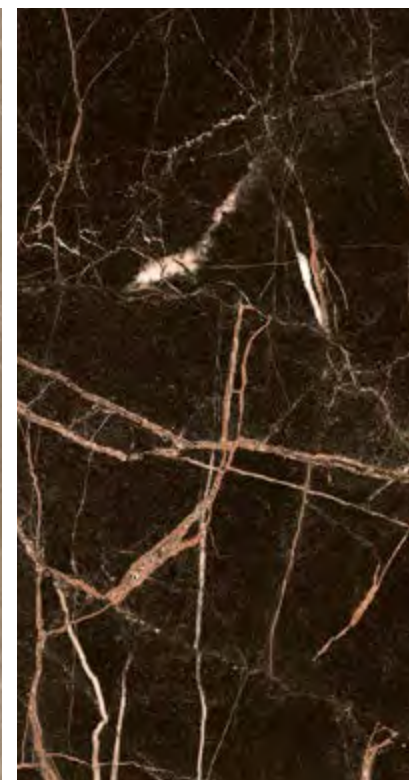

endless amazonite ED5 P. 133

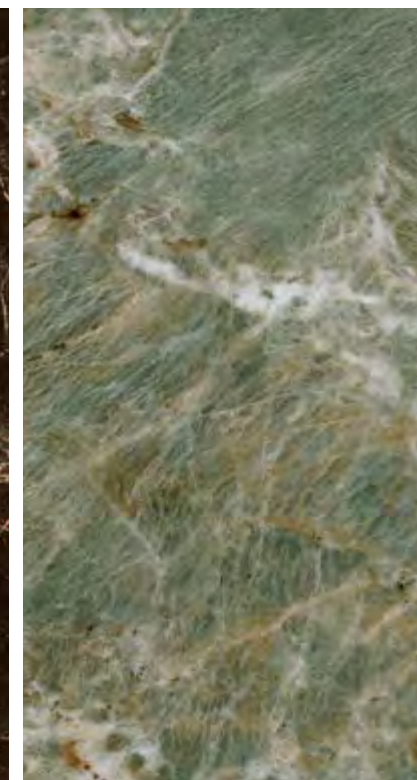

colour map

— concrete look

1 / 2 ▶

subway white SW1 P. 236

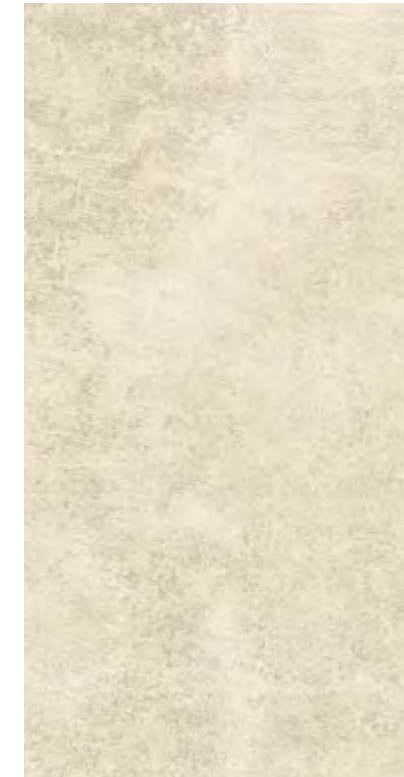

evoked white EV1 P. 174



tool white TL1 P. 218



metropolis white MT1 P. 104

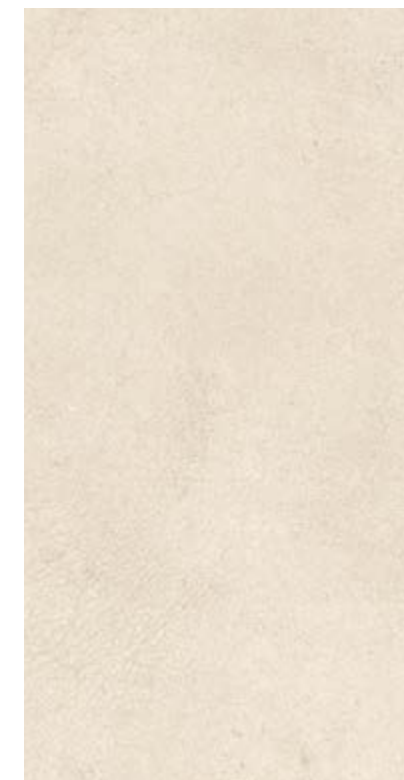

metropolis beige MT2 P. 104



evoked beige EV2 P. 174



index

colour map

chromatic look

concrete look

marble look

stone look

wood look

collections

linea collections

useful information

Tabela Preços



colour map

— concrete look

◀ 1 / 2

scale 1:3

evoked light grey EV3 P. 175



tool light grey TL2 P. 219



metropolis light grey MT4 P. 105

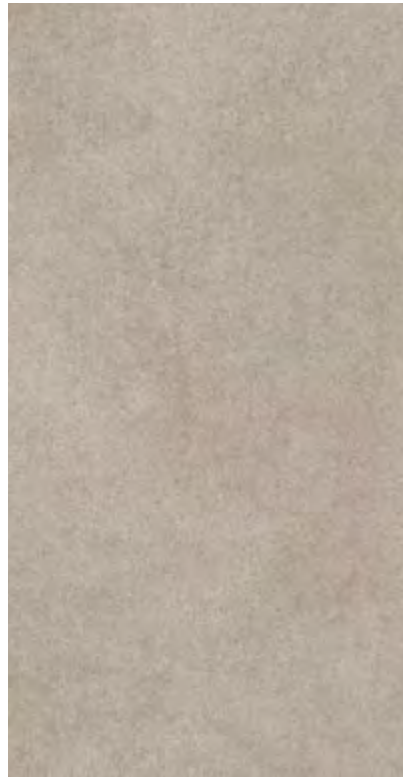

subway ash SW2 P. 237



evoked grey EV4 P. 175



metropolis grey MT5 P. 105



tool tortora TL3 P. 218



subway clay LSW3 P. 236



tool grey TL4 P. 219

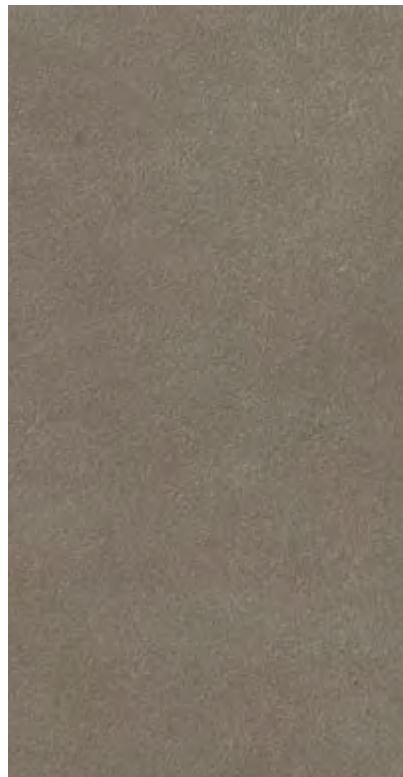

subway smoke LSW4 P. 237



metropolis terracotta MT3 P. 104

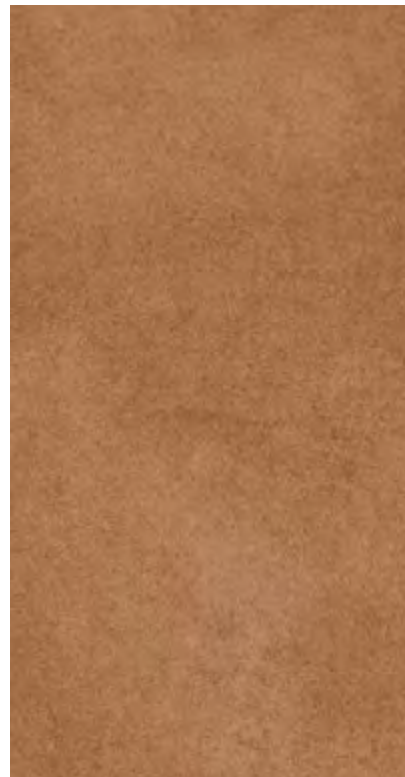

MARGRES
CERAMIC TILES

colour map

concrete look —

index

colour map

chromatic look

concrete look

marble look

stone look

wood look

collections

linea collections

useful information

Tabela Preços



colour map

— chromatic look

scale 1:3

time 2.0 snow T21 P. 248



time 2.0 white T22 P. 248



time 2.0 cream T23 P. 248



time 2.0 beige T24 P. 249



time 2.0 dove T25 P. 249



cosmos corten LCM1 P. 299

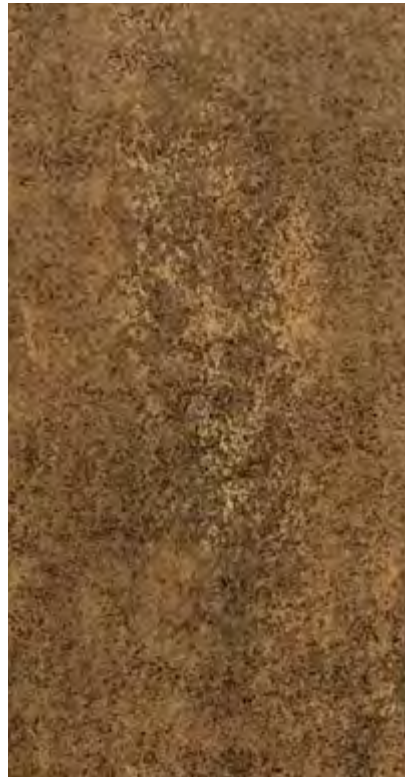

time 2.0 silver T26 P. 250



time 2.0 grey T27 P. 250



time 2.0 carbon T28 P. 251



time 2.0 black T29 P. 251



cosmos iron LCM2 P. 299



colour map

chromatic look —

index

colour map

chromatic look

concrete look

marble look

stone look

wood look

collections

linea collections

useful information

Tabela Preços



collections

collections . kollektionen . coleções —

bare&bold	P. 25
concept	P. 189
deck plus	P. 85
endless	P. 125
evoke	P. 169
evolution	P. 57
fragment	P. 43
grove	P. 201
hybrid	P. 157
metropolis	P. 93
prestige	P. 179
pure stone	P. 137
slabstone	P. 223
stage	P. 111
subway	P. 233
tecnica	P. 255
thunder	P. 73
time 2.0	P. 241
tool	P. 211

23
|
general catalogue . 2026

MARGRES
CERAMIC TILES

index —

colour map —

collections —

- bare&bold
- concept
- deck plus
- endless
- evoke
- evolution
- fragment
- grove
- hybrid
- metropolis
- prestige
- pure stone
- slabstone
- stage
- subway
- tecnica
- thunder
- time 2.0
- tool

linea collections —

useful information —



bare cream BB1 20x120 NR

DIGITEK
PORCELAIN
STONEWARE

bare&bold

collection

3D TOUCH

↓
DOWNLOAD
CATALOGUE

↓
DOWNLOAD
TECHNICAL
FEATURES

🌐
VIEW
ONLINE

bare



20x120
NR 9,5mm

bold



40x120
E ASR 20mm



20x120
NR.ASR 9,5mm

rectified products . produits rectifiés . rektifizierete produkte . produtos retificados



bare
cream
BB1

bold
cream
BB4

bare
beige
BB2

bold
beige
BB5

bare
dark beige
BB3

bold
dark beige
BB6

UGL V2 R11 R10
ASR . E ASR NR

PR()TECT®

Antibacterial for Life.

MARGRES
CERAMIC TILES

index

colour map

collections

bare&bold

concept

deck plus

endless

evoke

evolution

fragment

grove

hybrid

metropolis

prestige

pure stone

slabstone

stage

subway

tecnica

thunder

time 2.0

tool

linea collections

useful information

bare&bold

— collection



MARGRES
CERAMIC TILES



bare&bold

collection —

bare beige BB2 20x120 NR

index

colour map

collections

bare&bold

concept

deck plus

endless

evoke

evolution

fragment

grove

hybrid

metropolis

prestige

pure stone

slabstone

stage

subway

tecnica

thunder

time 2.0

tool

linea collections

useful information

bare&bold

— collection



28

general catalogue . 2026

chevron bare dark beige 10x10

bare&bold

collection —



29

general catalogue . 2026

bare dark beige BB3 20x120 NR

index



colour map



collections



bare&bold

concept

deck plus

endless

evoke

evolution

fragment

grove

hybrid

metropolis

prestige

pure stone

slabstone

stage

subway

tecnica

thunder

time 2.0

tool

linea collections



useful information



collections

bare&bold

concept

deck plus

endless

evoke

evolution

fragment

grove

hybrid

metropolis

prestige

pure stone

slabstone

stage

subway

tecnica

thunder

time 2.0

tool

linea collections

useful information

collections

bare&bold

- concept
- deck plus
- endless
- evoke
- evolution
- fragment
- grove
- hybrid
- metropolis
- prestige
- pure stone
- slabstone
- stage
- subway
- tecnica
- thunder
- time 2.0
- tool

linea collections

useful information



bare&bold

collection

bare&bold

collection

index

colour map

collections

bare&bold

concept

deck plus

endless

evoke

evolution

fragment

grove

hybrid

metropolis

prestige

pure stone

slabstone

stage

subway

tecnica

thunder

time 2.0

tool

linea collections

useful information

36

general catalogue - 2026

37

general catalogue - 2026

bold dark beige BB6 40x120 E ASR

bare&bold

collection

3D TOUCH

bare cream **BB1** NR

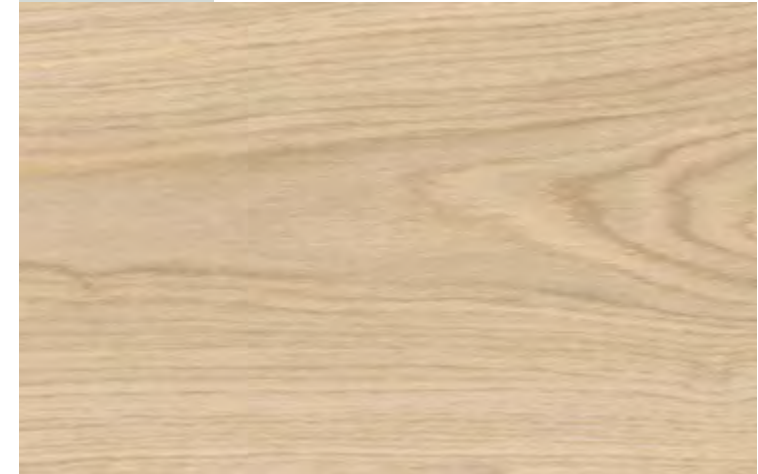

20x120 9,5mm NR R10 B MG-1240

bare beige **BB2** NR



20x120 9,5mm NR R10 B MG-1240

bare dark beige **BB3** NR

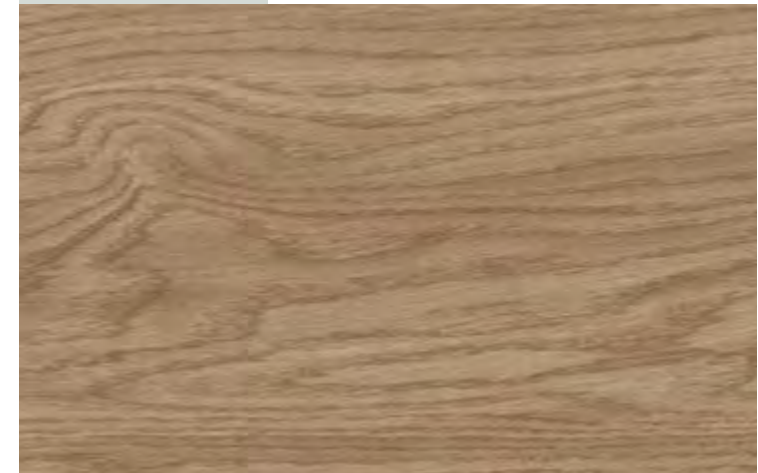

20x120 9,5mm NR R10 B MG-1240

20x120	9,5mm	NR	R10	B	MG-1240
		ASR	R11	C	MG-1270
40x120	20mm	E ASR	R11	C	MG-7290

20x120	9,5mm	NR	R10	B	MG-1240
		ASR	R11	C	MG-1270
40x120	20mm	E ASR	R11	C	MG-7290

20x120	9,5mm	NR	R10	B	MG-1240
		ASR	R11	C	MG-1270
40x120	20mm	E ASR	R11	C	MG-7290

bare&bold

collection

bold cream **BB4**



bold beige **BB5**



bold dark beige **BB6**



index

colour map

collections

bare&bold

concept

deck plus

endless

evoke

evolution

fragment

grove

hybrid

metropolis

prestige

pure stone

slabstone

stage

subway

tecnica

thunder

time 2.0

tool

linea collections

useful information

bare&bold

collection

3D TOUCH

decors

décorations . dekorationen . decorações

9,5MM



chevron bare cream
10x50
NR MG-9740



chevron bold cream
20x100
NR MG-9525



chevron bare beige
10x50
NR MG-9740



chevron bold beige
20x100
NR MG-9525



chevron bare dark beige
10x50
NR MG-9740



chevron bold dark beige
20x100
NR MG-9525

special pieces

pièces spéciales . spezialteile . peças especiais

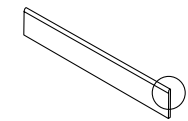

skirting
plinthe
sockel
rodapé
8x120
NR MP-6260

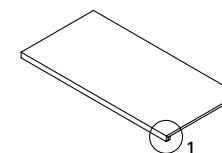
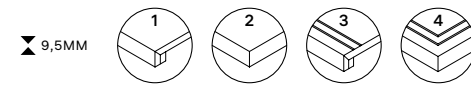

step tread "L"
nez de marche "L"
stufenplatte "L"
degrau "L"
30x120
NR . ASR** MP-6595

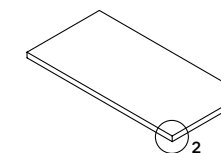

* step tread "L" corner
nez de marche "L" angle
ecke stufenplatte "L"
degrau "L" canto
30x120
NR . ASR** MP-6655

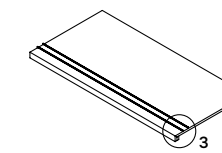

step tread "L" inox
nez de marche "L" inox
stufenplatte "L" inox
degrau "L" inox
30x120
NR MP-6670

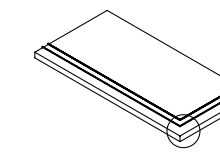

* step tread "L" corner inox
nez de marche "L" angle inox
ecke stufenplatte "L" inox
degrau "L" canto inox
30x120
NR MP-6710



step tread "L" corner . nez de marche "L" angle
ecke stufenplatte "L" . degrau "L" canto



step tread "L" corner inox . nez de marche "L" angle inox
ecke stufenplatte "L" inox . degrau "L" canto inox

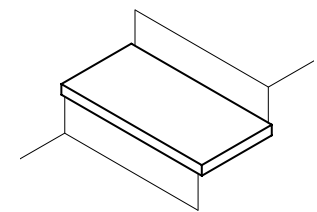

right corner . angle droit
rechten ecke . canto direito

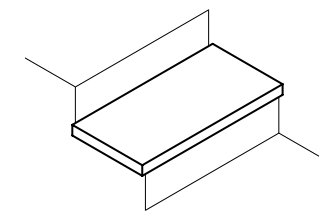

left corner . angle gauche
links ecke . canto esquerdo

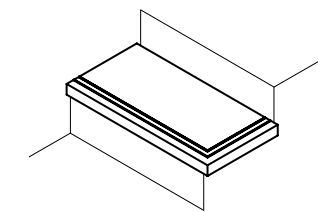

right corner . angle droit
rechten ecke . canto direito

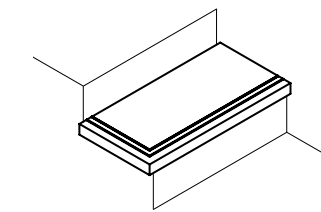

left corner . angle gauche
links ecke . canto esquerdo

* Available in right and left corner
Disponible dans les coin droit et gauche
Erhältlich in der rechten Ecke und links
Disponível no canto direito e esquerdo

** ASR: Disponível nas cores: Bold Cream, Bold Beige e Bold Dark Beige
ASR: Available in colours: Bold Cream, Bold Beige e Bold Dark Beige
ASR: Disponible dans les couleurs: Bold Cream, Bold Beige e Bold Dark Beige
ASR: Erhältlich in den Farben: Bold Cream, Bold Beige e Bold Dark Beige

OUTDOOR

EXTRA THICK
Special 20MM pieces please refer to page 348.
Pièces spéciales 20MM, veuillez consulter la page 348.
Speziellanfertigungen 20MM siehe Seite 348.
Peças especiais 20MM, por favor consulte a página 348.

index

colour map

collections

bare&bold

concept

deck plus

endless

evoke

evolution

fragment

grove

hybrid

metropolis

prestige

pure stone

slabstone

stage

subway

tecnica

thunder

time 2.0

tool

linea collections

useful information



42

general catalogue . 2026

white FR1 60x120 NR . metropolis white MT1 60x120 A

FULL BODY
PORCELAIN

3D TOUCH

fragment

collection

↓
DOWNLOAD
CATALOGUE

↓
DOWNLOAD
TECHNICAL
FEATURES

🌐
VIEW
ONLINE



60x120
NR 9,5mm



90x90
NR 9,5mm



60x60
NR 8,5mm

rectified products . produits rectifiés . rektifizierete produkte . produtos retificados



white
FR1

terracotta
FR3

grey
FR5

UGL V2 R9

PR()TECT®

Antibacterial for Life.

MARGRES
CERAMIC TILES

index

colour map

collections

bare&bold

concept

deck plus

endless

evoke

evolution

fragment

grove

hybrid

metropolis

prestige

pure stone

slabstone

stage

subway

tecnica

thunder

time 2.0

tool

linea collections

useful information

43

general catalogue . 2026

fragment

— collection



44

general catalogue . 2026

MARGRES
CERAMIC TILES

fragment

collection —



45

general catalogue . 2026

white FR1 60x120 NR . diagram white 60x120 NR . stage brown SE5 20x120 NR

index



colour map



collections



bare&bold

concept

deck plus

endless

evoke

evolution

fragment

grove

hybrid

metropolis

prestige

pure stone

slabstone

stage

subway

tecnica

thunder

time 2.0

tool

linea collections



useful information



fragment

— collection



46

general catalogue, 2026

terracotta FR3 90x90 NR

fragment

— collection



47

general catalogue, 2026

terracotta FR3 60x120 NR . metropolis terracotta MT3

index



colour map



collections



bare&bold

concept

deck plus

endless

evoke

evolution

fragment

grove

hybrid

metropolis

prestige

pure stone

slabstone

stage

subway

tecnica

thunder

time 2.0

tool

linea collections



useful information



fragment

— collection



48

general catalogue . 2026

grey FR5 90x90 NR

fragment

collection —



49

general catalogue . 2026

grey FR5 60x120 NR

index

colour map

collections

bare&bold

concept

deck plus

endless

evoke

evolution

fragment

grove

hybrid

metropolis

prestige

pure stone

slabstone

stage

subway

tecnica

thunder

time 2.0

tool

linea collections

useful information

fragment

— collection



MARGRES
CERAMIC TILES

fragment

— collection



grey FR5 60x120 NR . 60x60 NR

index

—
colour map

collections

—
bare&bold

concept

deck plus

endless

evoke

evolution

fragment

—
grove

hybrid

metropolis

prestige

pure stone

slabstone

stage

subway

tecnica

thunder

time 2.0

—
tool

—
linea collections

—
useful information

fragment

collection

3D TOUCH

white FR1

NR



60x60	8,5mm	NR	R9	A	MG-2795
90x90	9,5mm	NR	R9	A	MG-4010
60x120	9,5mm	NR	R9	A	MG-4730

terracotta FR3

NR



60x60	8,5mm	NR	R9	A	MG-2795
90x90	9,5mm	NR	R9	A	MG-4010
60x120	9,5mm	NR	R9	A	MG-4730

grey FR5

NR



60x60	8,5mm	NR	R9	A	MG-2795
90x90	9,5mm	NR	R9	A	MG-4010
60x120	9,5mm	NR	R9	A	MG-4730

decors

décorations . dekorationen . decorações

9,5 MM



diagram white

60x120

NR MG-4865



Decoration available in 4 different patterns, sold randomly.

Décoration avec 4 pièces différentes et vendues de façon aléatoire.

Dekoration in 4 verschiedenen Mustern erhältlich, nach dem Zufallsprinzip verkauft.

Decoração com 4 peças diferentes e vendidas aleatoriamente.

fragment

collection

index

colour map

collections

bare&bold

concept

deck plus

endless

evoke

evolution

fragment

grove

hybrid

metropolis

prestige

pure stone

slabstone

stage

subway

tecnica

thunder

time 2.0

tool

linea collections

useful information

PROTECT

Antibacterial for Life.

An exclusive line of extremely high performance antimicrobial floor and wall tiles, designed for healthy, safe and protected living spaces.

Une ligne exclusive de sols et revêtements antibactériens aux performances très élevées, pour un habitat sain, sûr et protégé.

Eine exklusive Linie an hochwertigen Fußböden und antibakteriellen Wandverkleidungen, für ein gesundes, sicheres und geschütztes Leben.

Uma linha exclusiva de pavimentos e revestimentos antimicrobianos de altíssima performance, projetada para ambientes saudáveis, seguros e protegidos.

MARGRES
CERAMIC TILES

fragment . metropolis mix&match

collection

fragment

collection

The combination of the **Fragment** and **Metropolis** collections reveals the power of mix & match: similar tones that balance and dialogue with each other, creating versatile combinations that awaken Margres' most creative side.

L'union des collections **Fragment** et **Metropolis** révèle la puissance du mix & match : des tons similaires qui s'équilibrent et dialoguent entre eux, créant des combinaisons polyvalentes qui éveillent le côté le plus créatif de Margres.

Die Verbindung der Kollektionen **Fragment** und **Metropolis** zeigt die Kraft des mix & match: ähnliche Farbtöne, die sich gegenseitig ausgleichen und miteinander kommunizieren, schaffen vielseitige Kombinationen, die die kreativere Seite von Margres zum Vorschein bringen.

A união da coleção **Fragment** e **Metropolis** revela o poder do mix & match: tons semelhantes que se equilibram e dialogam entre si, criando combinações versáteis que despertam o lado mais criativo da Margres.

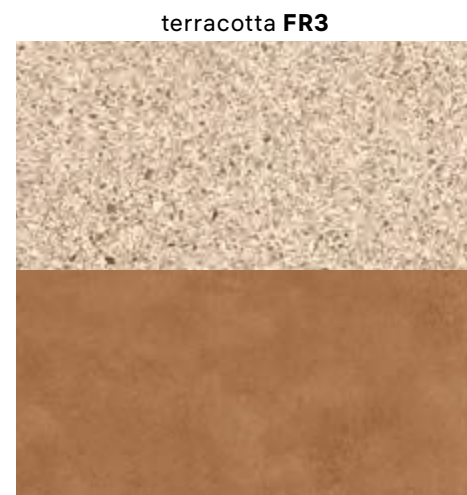
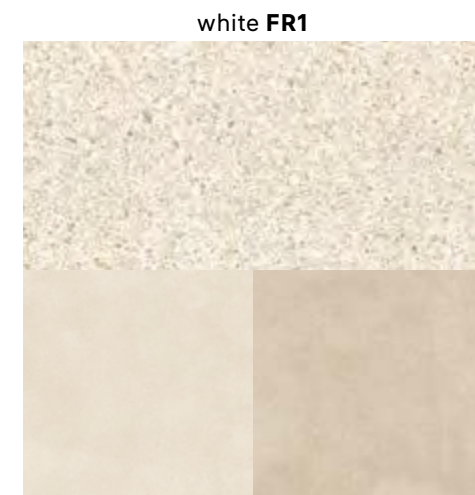

white **FR1**
white **MT1**

terracotta **FR3**
terracotta **MT3**

grey **FR5**
light grey **MT4**
grey **MT5**



special pieces

pièces spéciales . spezialteile . peças especiais

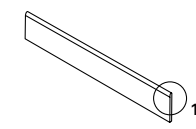
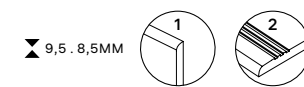

skirting
plinthe
sockel
rodapé

8x60
NR MP-6170
8x90
NR MP-6260
8x120
NR MP-6260

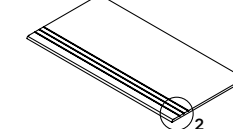

step tread grooved
nez de marche creusé
stufenplatte mit rillen
degrau sulcado

30x60
NR MP-6240
30x90
NR MP-6430
30x120
NR MP-6445

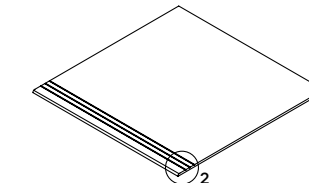

step tread grooved
nez de marche creusé
stufenplatte mit rillen
degrau sulcado

60x60
NR MP-6400

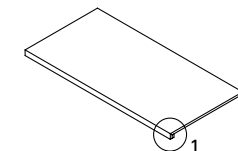
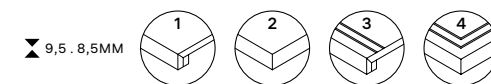

step tread "L"
nez de marche "L"
stufenplatte "L"
degrau "L"

30x60
NR MP-6560
30x90
NR MP-6590
30x120
NR MP-6595

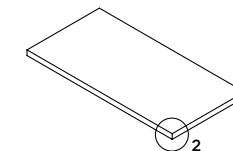

* step tread "L" corner
nez de marche "L" angle
ecke stufenplatte "L"
degrau "L" canto

30x60
NR MP-6630
30x90
NR MP-6645
30x120
NR MP-6655

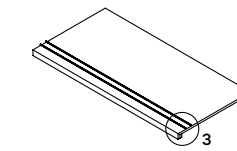

step tread "L" inox
nez de marche "L" inox
stufenplatte "L" inox
degrau "L" inox

30x60
NR MP-6580
30x90
NR MP-6640
30x120
NR MP-6670

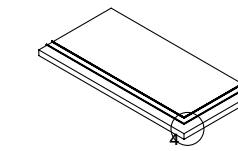

* step tread "L" corner inox
nez de marche "L" angle inox
ecke stufenplatte "L" inox
degrau "L" canto inox

30x60
NR MP-6650
30x90
NR MP-6690
30x120
NR MP-6710



step tread "L" corner . nez de marche "L" angle
ecke stufenplatte "L" . degrau "L" canto

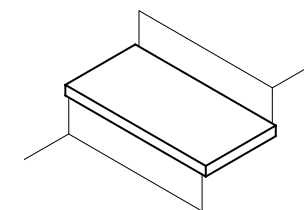

right corner . angle droit
rechten ecke . canto direito

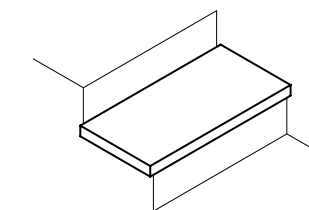

left corner . angle gauche
links ecke . canto esquerdo



step tread "L" corner inox . nez de marche "L" angle inox
ecke stufenplatte "L" inox . degrau "L" canto inox

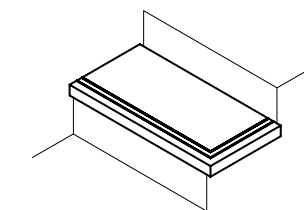

right corner . angle droit
rechten ecke . canto direito

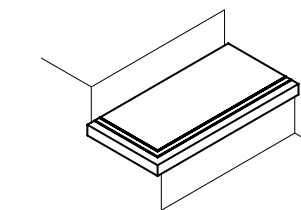

left corner . angle gauche
links ecke . canto esquerdo

Available in all colours
Disponible dans toutes les couleurs
Erhältlich in allen Farben
Disponível em todas as cores

* Available in right and left corner
Disponible dans les coin droit et gauche
Erhältlich in der rechten Ecke und links
Disponível no canto direito e esquerdo

** Dimension will vary depending on the base tile thickness.
La dimension varie selon l'épaisseur du carreau.
Das Maß variiert je nach Dicke der Fliese.
A dimensão varia consoante a espessura do material cerâmico.



white EN1 60x120 A . mosaic hexagon white 24,7x28,6

LAMINATED
PORCELAIN
STONEWARE

FULL BODY
PORCELAIN

evolution

collection —



120x278
A 6mm

↓
DOWNLOAD
BIM

↓
DOWNLOAD
CATALOGUE

↓
DOWNLOAD
TECHNICAL
FEATURES

↓
VIEW
ONLINE

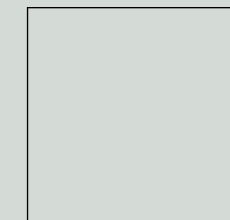

120x120
A 6mm

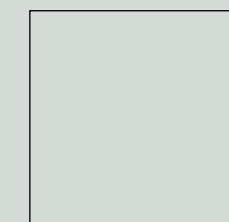

120x120
NR 9mm



60x120
NR . A 9,5mm

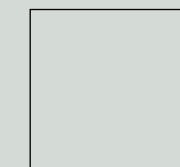

90x90
NR . A 9,5mm
ASR 9,5mm
E ASR 20mm

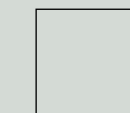

60x60
NR . A 8,5mm
ASR 8,5mm



30x60
NR 8,5mm

rectified products . produits rectifiés . rektifizierete produkte . produtos retificados

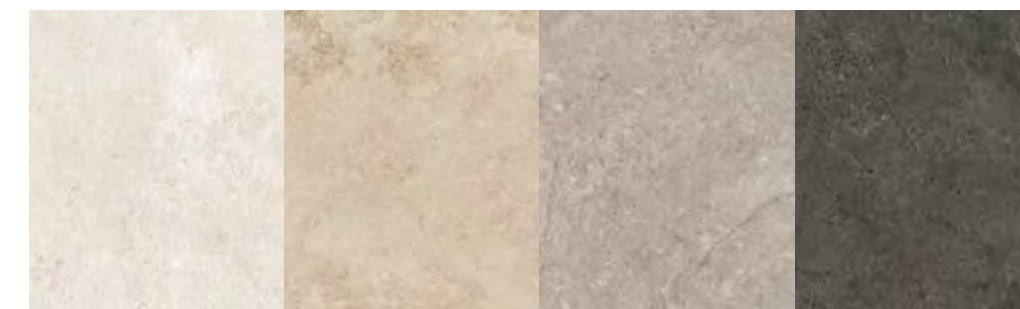

white
EN1 . LEN1

beige
EN2 . LEN2

light grey
EN3 . LEN3

black
EN4 . LEN4

UGL V2 R11 R10 

ASR NR
E ASR

BIM

QB UPEC

pour plus d'informations, consultez
<https://evaluation.cstb.fr>

PROTECT

Antibacterial for Life.

MARGRES
CERAMIC TILES

index

colour map

collections

bare&bold

concept

deck plus

endless

evoke

evolution

fragment

grove

hybrid

metropolis

prestige

pure stone

slabstone

stage

subway

tecnica

thunder

time 2.0

tool

linea collections

useful information

evolution

— collection



MARGRES
CERAMIC TILES

evolution

collection —



rome beige 60x120 NR . beige EN2 60x120 NR . 60x60 NR

index

colour map

collections

bare&bold

concept

deck plus

endless

evoke

evolution

fragment

grove

hybrid

metropolis

prestige

pure stone

slabstone

stage

subway

tecnica

thunder

time 2.0

tool

linea collections

useful information

evolution

— collection



60

general catalogue . 2026

evolution

collection —



61

general catalogue . 2026

index



colour map



collections



bare&bold

concept

deck plus

endless

evolve

evolution

fragment

grove

hybrid

metropolis

prestige

pure stone

slabstone

stage

subway

tecnica

thunder

time 2.0

tool

linea collections



useful information



MARGRES
CERAMIC TILES

beige EN2 90x90 NR . 90x90 ASR . overflow grille beige . overflow grille corner beige 15x60 E ASR . bullnose . bullnose inter corner beige 30x60 E ASR

evolution

collection

evolution

collection

index

colour map

collections

bare&bold

concept

deck plus

endless

evoke

evolution

fragment

grove

hybrid

metropolis

prestige

pure stone

slabstone

stage

subway

tecnica

thunder

time 2.0

tool

linea collections

useful information

62

general catalogue 2023

63

general catalogue 2023

light grey EN3 60x120 NR . 90x90 E ASR

evolution

— collection



64

general catalogue . 2026

light grey EN3 120x120 NR . rome light grey 60x120 NR



evolution

— collection

65

general catalogue . 2026

black EN4 120x120 NR

index



colour map



collections



bare&bold

concept

deck plus

endless

evoke

evolution

fragment

grove

hybrid

metropolis

prestige

pure stone

slabstone

stage

subway

tecnica

thunder

time 2.0

tool

linea collections



useful information



evolution

— collection

white EN1 . LEN1 A NR ASR E ASR



30x60	8,5mm	NR	R10	B	MG-2095
	8,5mm	NR	R10	B	MG-2765
	8,5mm	A	-	-	MG-3080
60x60	8,5mm	ASR	R11	C	MG-2765
	9,5mm	NR	R10	B	MG-3960
	9,5mm	A	-	-	MG-4290
90x90	9,5mm	ASR	R11	C	MG-3960
	20mm	E ASR	R11	C	MG-7690
	9,5mm	NR	R10	B	MG-4695
60x120	9,5mm	A	-	-	MG-4970
	9mm	NR	R10	B	MG-5450
LINEA					
120x120	6mm	A	-	-	M3-6780
120x278	6mm	A	-	-	M3-8270

beige EN2 . LEN2 A NR ASR E ASR

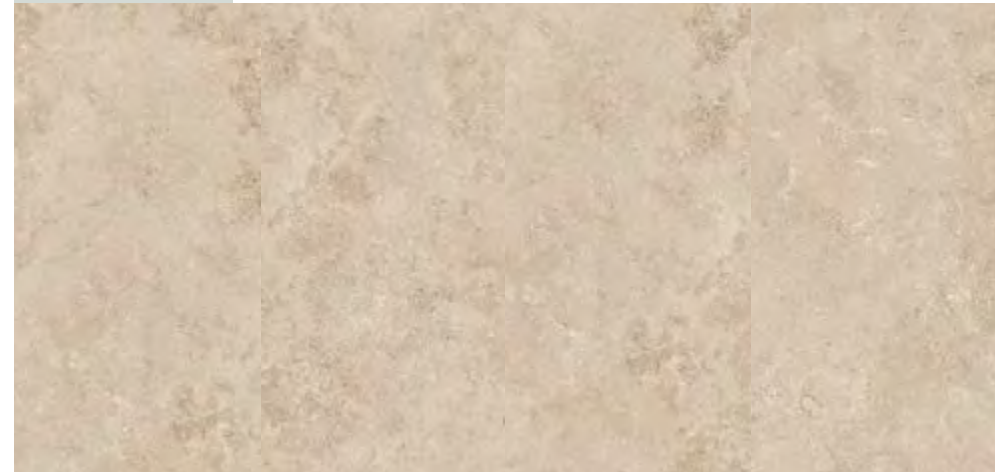

30x60	8,5mm	NR	R10	B	MG-2095
	8,5mm	NR	R10	B	MG-2765
	8,5mm	A	-	-	MG-3080
60x60	8,5mm	ASR	R11	C	MG-2765
	9,5mm	NR	R10	B	MG-3960
	9,5mm	A	-	-	MG-4290
90x90	9,5mm	ASR	R11	C	MG-3960
	20mm	E ASR	R11	C	MG-7690
	9,5mm	NR	R10	B	MG-4695
60x120	9,5mm	A	-	-	MG-4970
	9mm	NR	R10	B	MG-5450
LINEA					
120x120	6mm	A	-	-	M3-6780
120x278	6mm	A	-	-	M3-8270

evolution

collection —

E ASR ASR NR A light grey EN3 . LEN3



30x60	8,5mm	NR	R10	B	MG-2095
	8,5mm	NR	R10	B	MG-2765
	8,5mm	A	-	-	MG-3080
60x60	8,5mm	ASR	R11	C	MG-2765
	9,5mm	NR	R10	B	MG-3960
	9,5mm	A	-	-	MG-4290
90x90	9,5mm	ASR	R11	C	MG-3960
	20mm	E ASR	R11	C	MG-7690
	9,5mm	NR	R10	B	MG-4695
60x120	9,5mm	A	-	-	MG-4970
	9mm	NR	R10	B	MG-5450
LINEA					
120x120	6mm	A	-	-	M3-6780
120x278	6mm	A	-	-	M3-8270

E ASR ASR NR A black EN4 . LEN4



30x60	8,5mm	NR	R10	B	MG-2095
	8,5mm	NR	R10	B	MG-2765
	8,5mm	A	-	-	MG-3080
60x60	8,5mm	ASR	R11	C	MG-2765
	9,5mm	NR	R10	B	MG-3960
	9,5mm	A	-	-	MG-4290
90x90	9,5mm	ASR	R11	C	MG-3960
	20mm	E ASR	R11	C	MG-7690
	9,5mm	NR	R10	B	MG-4695
60x120	9,5mm	A	-	-	MG-4970
	9mm	NR	R10	B	MG-5450
LINEA					
120x120	6mm	A	-	-	M3-6780
120x278	6mm	A	-	-	M3-8270

index

colour map

collections

bare&bold

concept

deck plus

endless

evoke

evolution

fragment

grove

hybrid

metropolis

prestige

pure stone

slabstone

stage

subway

tecnica

thunder

time 2.0

tool

linea collections

useful information



rome light grey 60x120 NR

decors

décorations . dekorationen . decorações

8,5 - 9,5 MM



rome white
60x120

NR MG-4850



rome beige
60x120

NR MG-4850

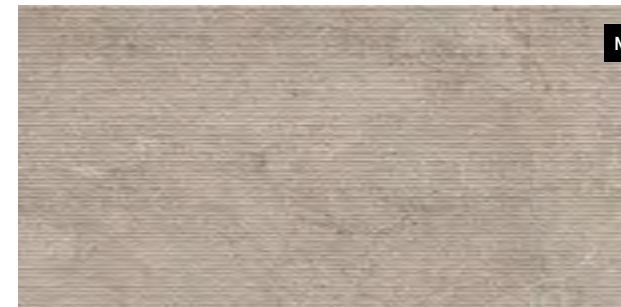

rome light grey
60x120

NR MG-4850



rome black
60x120

NR MG-4850

listel brushed gold*
1x1x120

MP-6500

listel brushed silver*
1x1x120

MP-6520

listel brushed copper*
1x1x120

MP-6560

*
Decorative pieces with precious metals are sensitive to acid attacks. For further information on cleaning metallic decorations – Gold, Silver and Copper – please see section 08 from page 357.
Les pièces décoratives en métaux précieux sont sensibles aux attaques d'acides. Pour des informations concernant le nettoyage des décors métalliques – Gold, Silver et Copper – veuillez consulter le point 08 à la page 357.
Dekorative teile mit Edelmetallen sind gegen Säure empfindlich. Informationen zur Reinigung der Metalldekorationen – Gold, Silver und Copper – finden Sie in Punkt 08 auf Seite 357.
Peças decorativas com metais preciosos são sensíveis aos ataques ácidos. Para informações sobre limpeza das decorações metálicas – Gold, Silver e Copper – por favor consulte o ponto 08 da página 357.

bare&bold

concept

deck plus

endless

evoke

evolution

fragment

grove

hybrid

metropolis

prestige

pure stone

slabstone

stage

subway

tecnica

thunder

time 2.0

tool

evolution

collection

decors

décorations . dekorationen . decorações

8,5MM



mosaic evolution 5x5 white
30x30
A MG-9745



mosaic evolution 5x5 beige
30x30
A MG-9745

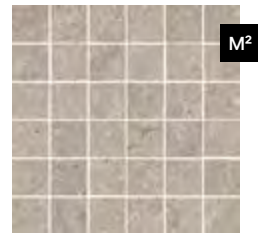

mosaic evolution 5x5 light grey
30x30
A MG-9745

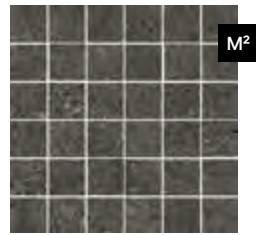

mosaic evolution 5x5 black
30x30
A MG-9745



mosaic hexagon evolution white
24,7x28,6
A MP-6330



mosaic hexagon evolution beige
24,7x28,6
A MP-6330



mosaic hexagon evolution light grey
24,7x28,6
A MP-6330



mosaic hexagon evolution black
24,7x28,6
A MP-6330

special pieces

pièces spéciales . spezialteile . peças especiais

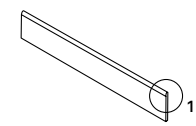
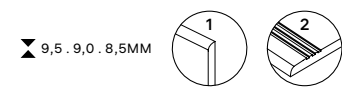

skirting
plinthe
socket
rodapé

8x60
NR MP-6170
A MP-6180

8x90
NR MP-6260
A MP-6270

8x120
NR MP-6260
A MP-6270

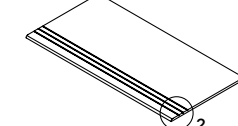

step tread grooved
nez de marche creusé
stufenplatte mit rillen
degrau sulcado

30x60
NR . ASR MP-6240
A MP-6270

30x90
NR . ASR MP-6430
A MP-6445

30x120
NR MP-6445
A MP-6470

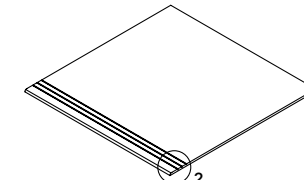

step tread grooved
nez de marche creusé
stufenplatte mit rillen
degrau sulcado

60x60
NR . ASR MP-6400
A MP-6430

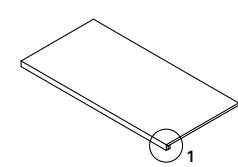
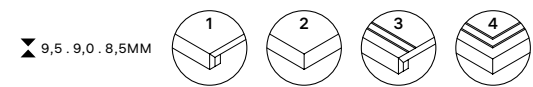
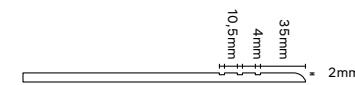

step tread "L"
nez de marche "L"
stufenplatte "L"
degrau "L"

30x60
NR . A . ASR MP-6560
30x90
NR . A . ASR MP-6590
30x120
NR . A MP-6595

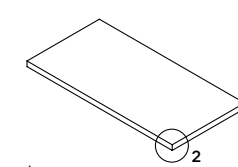

* step tread "L" corner
nez de marche "L" angle
ecke stufenplatte "L" inox
degrau "L" canto

30x60
NR . A . ASR MP-6630
30x90
NR . A . ASR MP-6645
30x120
NR . A MP-6655

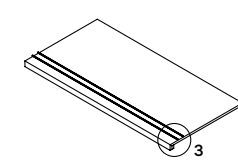

step tread "L" inox
nez de marche "L" inox
stufenplatte "L" inox
degrau "L" inox

30x60
NR . A MP-6580
30x90
NR . A MP-6640
30x120
NR . A MP-6670

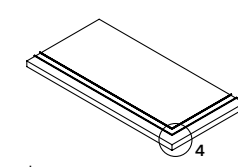

* step tread "L" corner inox
nez de marche "L" angle inox
ecke stufenplatte "L" inox
degrau "L" canto inox

30x60
NR . A MP-6650
30x90
NR . A MP-6690
30x120
NR . A MP-6710



step tread "L" corner . nez de marche "L" angle
ecke stufenplatte "L" . degrau "L" canto

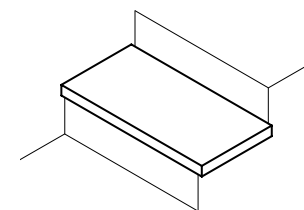

right corner . angle droit
rechten ecke . canto direito

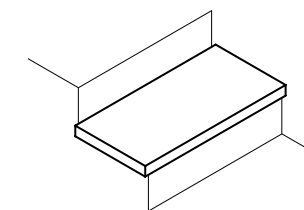

left corner . angle gauche
links ecke . canto esquerdo



step tread "L" corner inox . nez de marche "L" angle inox
ecke stufenplatte "L" inox . degrau "L" canto inox

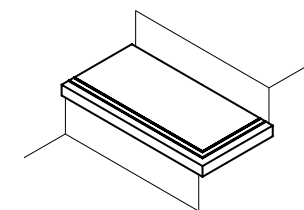

right corner . angle droit
rechten ecke . canto direito

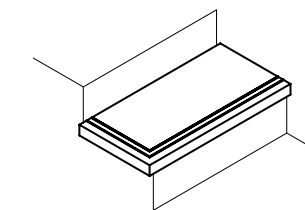

left corner . angle gauche
links ecke . canto esquerdo

OUTDOOR

EXTRA THICK
Special 20MM pieces please refer to page 348.
Pièces spéciales 20MM, veuillez consulter la page 348.
Speziellanfertigungen 20MM siehe Seite 348.
Peças especiais 20MM, por favor consulte a página 348.

Mosaic decor is net mounted. All decors may feature shade variations regarding the corresponding floor/wall tile standard tile.
La décoration Mosaic est sur trame. Toutes les décorations peuvent souffrir variations de tonalité par rapport aux carreaux base.
Die Mosaic Dekoration ist netzverklebt. Alle Dekorationen können im Vergleich zu den jeweiligen Grundiesen Farbunterschiede aufweisen.
A decoração Mosaic é sobre rede. Todas as decorações podem sofrer variações de tonalidade em relação aos respectivos mosaicos base.

MARGRES
CERAMIC TILES

Available in all colours
Disponible dans toutes les couleurs
Erhältlich in allen Farben
Disponível em todas as cores

* Available in right and left corner
Disponible dans les coin droit et gauche
Erhältlich in der rechten Ecke und links
Disponível no canto direito e esquerdo

** Dimension will vary depending on the base tile thickness.
La dimension varie selon l'épaisseur du carreau.
Das Maß variiert je nach Dicke der Fliese.
A dimensão varia consoante a espessura do material cerâmico.

index

colour map

collections

bare&bold

concept

deck plus

endless

evoke

evolution

fragment

grove

hybrid

metropolis

prestige

pure stone

slabstone

stage

subway

tecnica

thunder

time 2.0

tool

linea collections

useful information



beige TH1 60x120 NR . mosaic 3,5x3,5 beige 30x30 NR . anthracite TH3 90x90 NR

FULL BODY
PORCELAIN

thunder

collection

↓
DOWNLOAD
CATALOGUE

↓
DOWNLOAD
TECHNICAL
FEATURES

🌐
VIEW
ONLINE



60x120
NR 9,5mm



90x90
NR 9,5mm
ASR 9,5mm

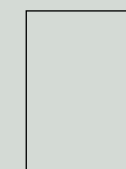

60x90
E ASR 20mm



60x60
NR 8,5mm
E ASR 20mm



30x60
NR 8,5mm

rectified products . produits rectifiés . rektifizierete produkte . produtos retificados

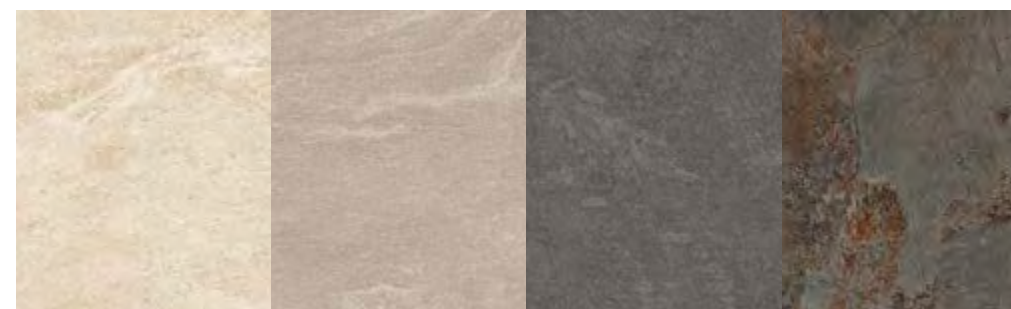

beige
TH1

light grey
TH2

anthracite
TH3

rust
TH4

UGL **V2** **R11** **R10**

ASR NR
E ASR

PR()TECT®

Antibacterial for Life.

MARGRES
CERAMIC TILES

index

colour map

collections

bare&bold

concept

deck plus

endless

evoke

evolution

fragment

grove

hybrid

metropolis

prestige

pure stone

slabstone

stage

subway

tecnica

thunder

time 2.0

tool

linea collections

useful information



74

75

general catalogue . 2026

general catalogue . 2026

beige TH1 90x90 ASR

index

colour map

collections

- bare&bold
- concept
- deck plus
- endless
- evolve
- evolution
- fragment
- grove
- hybrid
- metropolis
- prestige
- pure stone
- slabstone
- stage
- subway
- tecnica
- thunder**
- time 2.0
- tool

linea collections

useful information

thunder

— collection



MARGRES
CERAMIC TILES

thunder

collection —



light grey TH2 60x120 NR

index



colour map



collections



bare&bold

concept

deck plus

endless

evoke

evolution

fragment

grove

hybrid

metropolis

prestige

pure stone

slabstone

stage

subway

tecnica

thunder

time 2.0

tool

linea collections



useful information



thunder

— collection



78

general catalogue, 2026

rust TH4 90x90 NR

thunder

collection —



79

general catalogue, 2026

mosaic 3,5x3,5 anthracite 30x30 NR . anthracite TH3 60x120 NR

index

—

colour map

—

collections

—

bare&bold

concept

deck plus

endless

evoke

evolution

fragment

grove

hybrid

metropolis

prestige

pure stone

slabstone

stage

subway

tecnica

thunder

time 2.0

tool

linea collections

—

useful information

—

thunder

collection

beige TH1

NR

ASR . E ASR

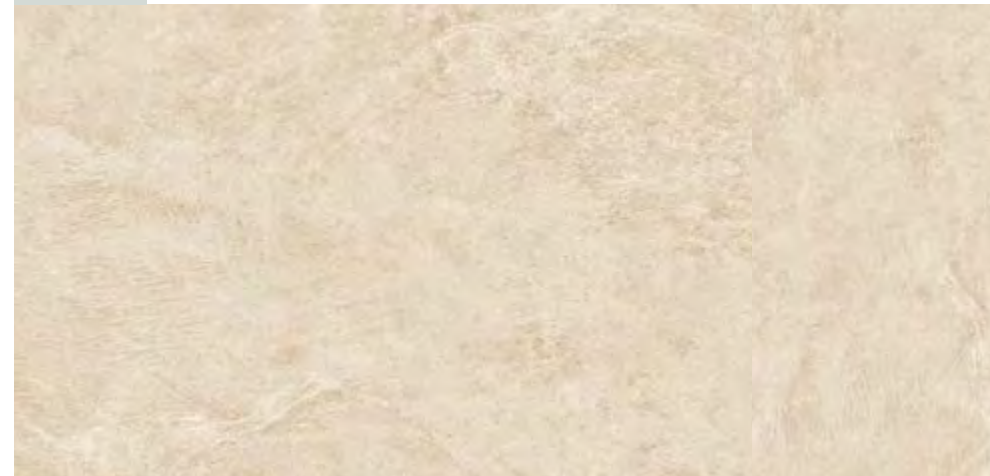

30x60	8,5mm	NR	R10	B	MG-2095
60x60	8,5mm	NR	R10	B	MG-2765
	20mm	E ASR	R11	C	MG-7090
60x90	20mm	E ASR	R11	C	MG-7180
90x90	9,5mm	NR	R10	B	MG-3960
	9,5mm	ASR	R11	C	MG-3960
60x120	9,5mm	NR	R10	B	MG-4695

light grey TH2

NR

ASR . E ASR



30x60	8,5mm	NR	R10	B	MG-2095
60x60	8,5mm	NR	R10	B	MG-2765
	20mm	E ASR	R11	C	MG-7090
60x90	20mm	E ASR	R11	C	MG-7180
90x90	9,5mm	NR	R10	B	MG-3960
	9,5mm	ASR	R11	C	MG-3960
60x120	9,5mm	NR	R10	B	MG-4695

thunder

collection

ASR . E ASR

NR

anthracite TH3



30x60	8,5mm	NR	R10	B	MG-2095
60x60	8,5mm	NR	R10	B	MG-2765
	20mm	E ASR	R11	C	MG-7090
60x90	20mm	E ASR	R11	C	MG-7180
90x90	9,5mm	NR	R10	B	MG-3960
	9,5mm	ASR	R11	C	MG-3960
60x120	9,5mm	NR	R10	B	MG-4695

ASR . E ASR

NR

rust TH4



60x60	NEW 8,5mm	NR	R10	B	MG-2765
	20mm	E ASR	R11	C	MG-7090
60x90	20mm	E ASR	R11	C	MG-7180
90x90	9,5mm	NR	R10	B	MG-3960
	9,5mm	ASR	R11	C	MG-3960
60x120	9,5mm	NR	R10	B	MG-4695

index

colour map

collections

- bare&bold
- concept
- deck plus
- endless
- evoke
- evolution
- fragment
- grove
- hybrid
- metropolis
- prestige
- pure stone
- slabstone
- stage
- subway
- tecnica
- thunder**
- time 2.0
- tool

linea collections

useful information

MARGRES
CERAMIC TILES

PROTECT
Antibacterial for Life.

An exclusive line of extremely high performance antimicrobial floor and wall tiles, designed for healthy, safe and protected living spaces. Anti-slip finish doesn't have antibacterial protection.
Une ligne exclusive de sols et revêtements antibactériens aux performances très élevées, pour un habitat sain, sûr et protégé. La finition antidérapante n'a pas de protection antibactérienne.
Eine exklusive Linie an hochwertigen Fußböden und antibakteriellen Wandverkleidungen, für ein gesundes, sicheres und geschütztes Leben. Die rutschfeste Oberfläche hat keinen antibakteriellen Schutz.
Uma linha exclusiva de pavimentos e revestimentos antimicrobianos de altíssima performance, projetada para ambientes saudáveis, seguros e protegidos. O acabamento antiderrapante não tem proteção antibacteriana.

thunder

collection

decors

décorations . dekorationen . decorações

8,5MM



mosaic thunder 3,5x3,5 beige
30x30
NR MG-9590

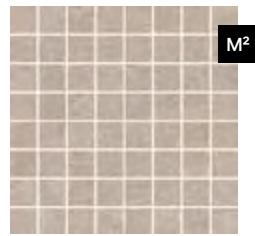

mosaic thunder 3,5x3,5 light grey
30x30
NR MG-9590

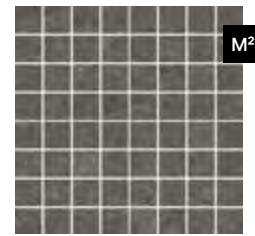

mosaic thunder 3,5x3,5 anthracite
30x30
NR MG-9590

8,5MM



bricks thunder beige
30x60
NR MP-6350



bricks thunder light grey
30x60
NR MP-6350



bricks thunder anthracite
30x60
NR MP-6350

Mosaic decor is net mounted. All decors may feature shade variations regarding the corresponding floor/wall tile standard tile.
La décoration Mosaic est sur trame. Toutes les décorations peuvent souffrir variations de tonalité par rapport aux carreaux base.
Die Mosaic Dekoration ist netzverklebt. Alle Dekorationen können im Vergleich zu den jeweiligen Grundiesen Farbunterschiede aufweisen.
A decoração Mosaic é sobre rede. Todas as decorações podem sofrer variações de tonalidade em relação aos respectivos mosaicos base.

MARGRES
CERAMIC TILES

thunder

collection

special pieces

pièces spéciales . spezialteile . peças especiais

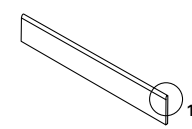
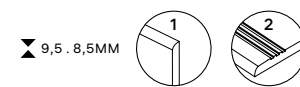

skirting
plinthe
socket
rodapé

8x60
NR MP-6170
8x90
NR MP-6260
8x120
NR MP-6260

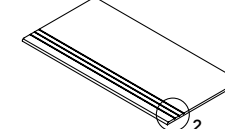

step tread grooved
nez de marche creusé
stufenplatte mit rillen
degrau sulcado

30x60
NR MP-6240
30x90
NR . ASR MP-6430
30x120
NR MP-6445

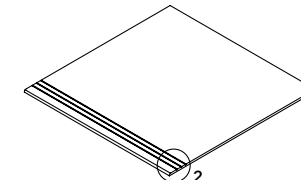

step tread grooved
nez de marche creusé
stufenplatte mit rillen
degrau sulcado

60x60
NR MP-6400

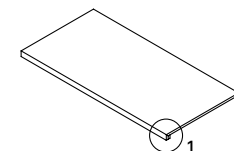
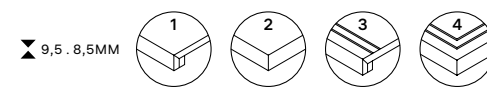

step tread "L"
nez de marche "L"
stufenplatte "L"
degrau "L"

30x60
NR MP-6560
30x90
NR . ASR MP-6590
30x120
NR MP-6595

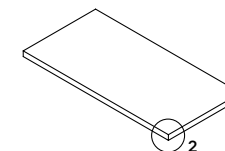

*
step tread "L" corner
nez de marche "L" angle
ecke stufenplatte "L"
degrau "L" canto

30x60
NR MP-6630
30x90
NR . ASR MP-6645
30x120
NR MP-6655

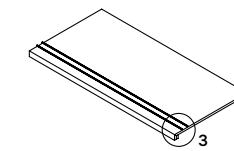

step tread "L" inox
nez de marche "L" inox
stufenplatte "L" inox
degrau "L" inox

30x60
NR MP-6580
30x90
NR . ASR MP-6640
30x120
NR MP-6670

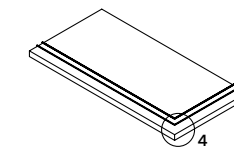

*
step tread "L" corner inox
nez de marche "L" angle
ecke stufenplatte "L" inox
degrau "L" canto inox

30x60
NR MP-6650
30x90
NR . ASR MP-6690
30x120
NR MP-6710

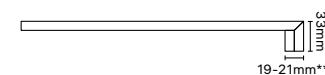

step tread "L" corner . nez de marche "L" angle
ecke stufenplatte "L" . degrau "L" canto

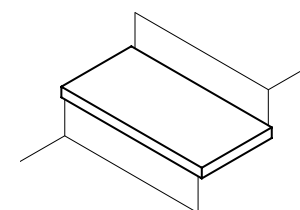

right corner . angle droit
rechten ecke . canto direito

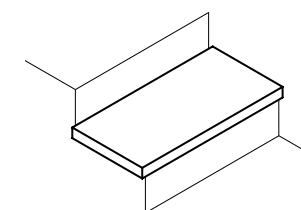

left corner . angle gauche
links ecke . canto esquerdo



step tread "L" corner inox . nez de marche "L" angle inox
ecke stufenplatte "L" inox . degrau "L" canto inox

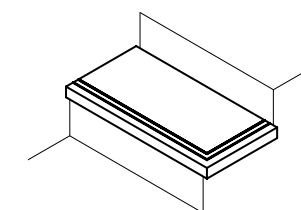

right corner . angle droit
rechten ecke . canto direito

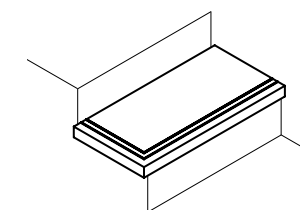

left corner . angle gauche
links ecke . canto esquerdo

Available in all colours
Disponible dans toutes les couleurs
Erhältlich in allen Farben
Disponível em todas as cores

* Available in right and left corner
Disponible dans les coin droit et gauche
Erhältlich in der rechten Ecke und links
Disponível no canto direito e esquerdo

** Dimension will vary depending on the base tile thickness.
La dimension varie selon l'épaisseur du carreau.
Das Maß variiert je nach Dicke der Fliese.
A dimensão varia consoante a espessura do material cerâmico.

OUTDOOR

EXTRA THICK
Special 20MM pieces please refer to page 348.
Pièces spéciales 20MM, veuillez consulter la page 348.
Speziellanfertigungen 20MM siehe Seite 348.
Peças especiais 20MM, por favor consulte a página 348.

index

colour map

collections

bare&bold

concept

deck plus

endless

evoke

evolution

fragment

grove

hybrid

metropolis

prestige

pure stone

slabstone

stage

subway

tecnica

thunder

time 2.0

tool

linea collections

useful information



wengue DP3 40x120 E ASR

DIGITEK
PORCELAIN
STONEWARE

deck plus

collection —

↓
DOWNLOAD
CATALOGUE

↓
DOWNLOAD
TECHNICAL
FEATURES

🌐
VIEW
ONLINE

NEW



40x120
E ASR 20mm



20x120
AS 9mm

AS non-rectified products . produits non rectifiés . nicht rektifizierte produkte . produtos não retificados
E ASR rectified products . produits rectifiés . rektifizierte produkte . produtos retificados

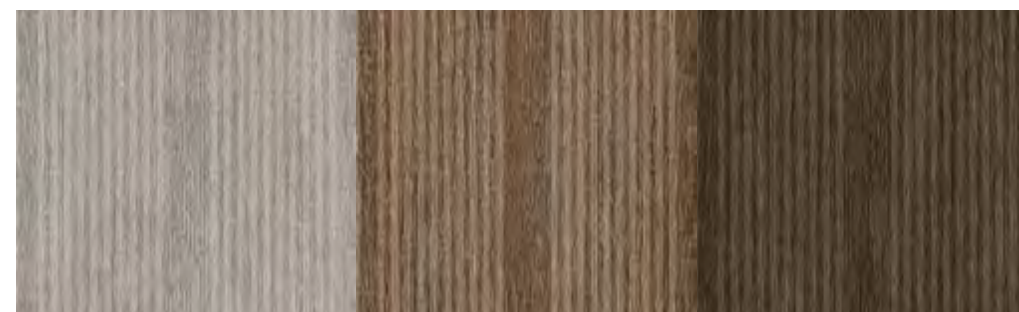

light grey
DP1

light brown
DP2

wenge
DP3

UGL V1 R11

MARGRES
CERAMIC TILES

index —

colour map —

collections —

bare&bold

concept

deck plus

endless

evoke

evolution

fragment

grove

hybrid

metropolis

prestige

pure stone

slabstone

stage

subway

tecnica

thunder

time 2.0

tool

linea collections —

useful information —

deck plus

— collection

deck plus

collection —

index

—

colour map

—

collections

—

bare&bold

concept

deck plus

endless

evoke

evolution

fragment

grove

hybrid

metropolis

prestige

pure stone

slabstone

stage

subway

tecnica

thunder

time 2.0

tool

linea collections

—

useful information

—



86

87

genera l catalogue . 2026

genera l catalogue . 2026

light brown DP2 40x120 E ASR

deck plus

— collection

deck plus

collection —

index

—

colour map

—

collections

—

bare&bold

concept

deck plus

endless

evoke

evolution

fragment

grove

hybrid

metropolis

prestige

pure stone

slabstone

stage

subway

tecnica

thunder

time 2.0

tool

linea collections

—

useful information

—

88

general catalogue - 2025

89

general catalogue - 2025

light grey DP1 20x120 AS

deck plus

— collection



light brown DP2 20x120 AS

MARGRES
CERAMIC TILES

deck plus

collection —

20x120 9mm AS R11 C MG-1160

20x120 9mm AS R11 C MG-1160

40x120 **NEW** 20mm **E ASR** R11 C MG-7290

20x120 9mm AS R11 C MG-1160

40x120 **NEW** 20mm **E ASR** R11 C MG-7290

AS

light grey DP1



AS . E ASR

light brown DP2



AS . E ASR

wenge DP3



laying suggestions

suggestions de pose . anwendungsvorschläge . sugestões de aplicação

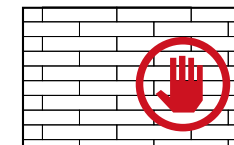
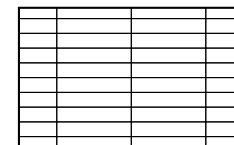

Not recommended
Non recommandé
Nicht empfohlen
Não recomendado

OUTDOOR
EXTRA THICK

Special 20MM pieces please refer to page 348.
Pièces spéciales 20MM, veuillez consulter la page 348.
Speziellanfertigungen 20MM siehe Seite 348.
Peças especiais 20MM, por favor consulte a página 348.

index

colour map

collections

bare&bold

concept

deck plus

endless

evoke

evolution

fragment

grove

hybrid

metropolis

prestige

pure stone

slabstone

stage

subway

tecnica

thunder

time 2.0

tool

linea collections

useful information



grey MT5 60x120 NR . 120x120 NR

FULL BODY
PORCELAIN

metropolis

collection

- ↓
DOWNLOAD
BIM
- ↓
DOWNLOAD
CATALOGUE
- ↓
DOWNLOAD
TECHNICAL
FEATURES
- 🌐
VIEW
ONLINE

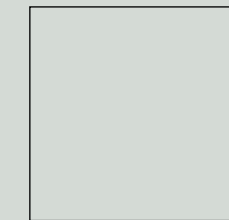

120x120
NR 9mm

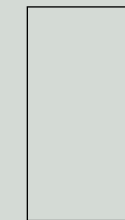

60x120
NR . TC . A 9,5mm
ASR 9,5mm



90x90
NR . TC . A 9,5mm
ASR 9,5mm



60x60
NR . TC 8,5mm
NEW ASR 8,5mm



30x60
NR 8,5mm

rectified products . produits rectifiés . rektifizierete produkte . produtos retificados



white
MT1

beige
MT2

terracotta
MT3

light grey
MT4

grey
MT5

UGL **V2** **R11** **R10**

ASR NR

BIM



pour plus d'informations, consultez
<https://evaluation.cstb.fr>

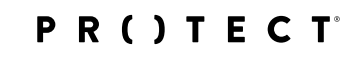

Antibacterial for Life.

MARGRES
CERAMIC TILES

index

colour map

collections

bare&bold

concept

deck plus

endless

evoke

evolution

fragment

grove

hybrid

metropolis

prestige

pure stone

slabstone

stage

subway

tecnica

thunder

time 2.0

tool

linea collections

useful information

bare&bold

concept

deck plus

endless

evoke

evolution

fragment

grove

hybrid

metropolis

prestige

pure stone

slabstone

stage

subway

tecnica

thunder

time 2.0

tool



94

general catalogue 2026

95

general catalogue 2026

metropolis

collection



white MT1 60x120 NR . 90x90 ASR

metropolis

collection



beige MT2 60x120 NR . 120x120 NR

index

colour map

collections

bare&bold

concept

deck plus

endless

evoke

evolution

fragment

grove

hybrid

metropolis

prestige

pure stone

slabstone

stage

subway

tecnica

thunder

time 2.0

tool

linea collections

useful information

metropolis

— collection



terracotta MT3 60x120 NR

98

general catalogue . 2026

metropolis

collection —



light grey MT4 120x120 NR

99

general catalogue . 2026

index



colour map



collections



bare&bold

concept

deck plus

endless

evoke

evolution

fragment

grove

hybrid

metropolis

prestige

pure stone

slabstone

stage

subway

tecnica

thunder

time 2.0

tool

linea collections



useful information



metropolis

— collection

metropolis

collection —

index

colour map

collections

bare&bold

concept

deck plus

endless

evoke

evolution

fragment

grove

hybrid

metropolis

prestige

pure stone

slabstone

stage

subway

tecnica

thunder

time 2.0

tool

linea collections

useful information

100

101

general catalogue . 2026

general catalogue . 2026

light grey MT4 60x120 NR

metropolis

— collection

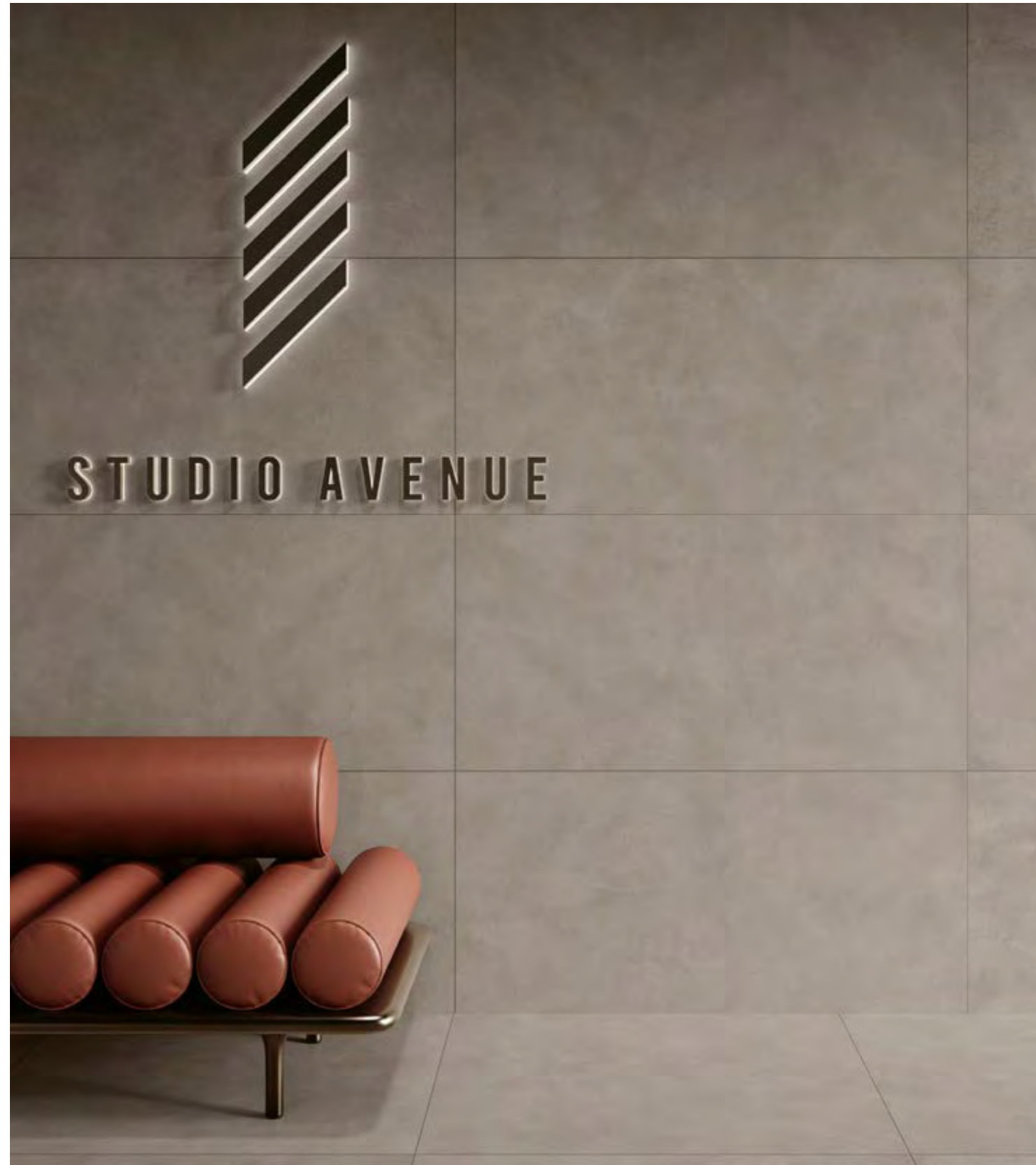

102

general catalogue . 2026

MARGRES
CERAMIC TILES



metropolis

collection —

103

general catalogue . 2026

grey MT5 60x120 NR . 90x90 NR

index



colour map



collections



bare&bold

concept

deck plus

endless

evoke

evolution

fragment

grove

hybrid

metropolis

prestige

pure stone

slabstone

stage

subway

tecnica

thunder

time 2.0

tool

linea collections



useful information



metropolis

collection

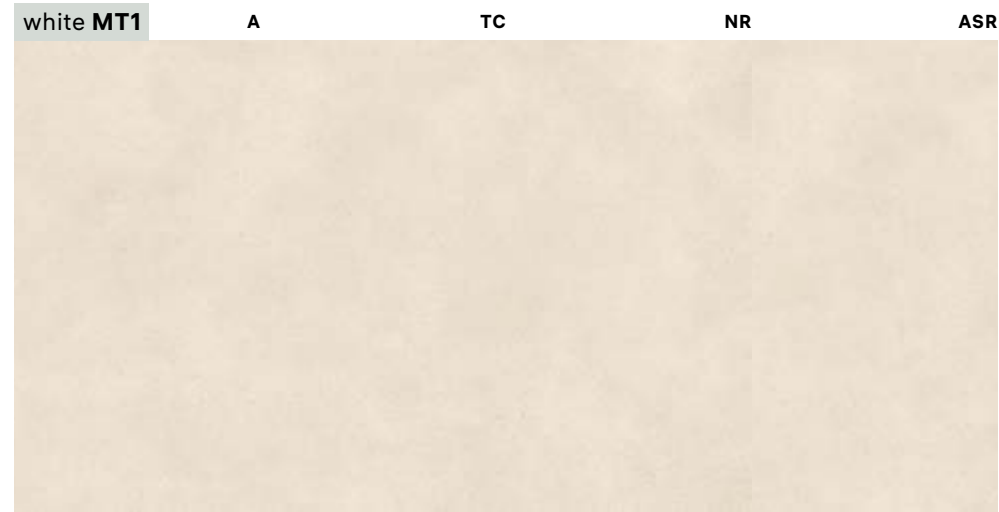

30x60	8,5mm	NR	R10	B	MG-2095
	8,5mm	NR	R10	B	MG-2765
60x60	8,5mm	TC	-	-	MG-2765
	NEW 8,5mm	ASR	R11	C	MG-2765
	9,5mm	NR	R10	B	MG-3960
	9,5mm	TC	-	-	MG-3960
90x90	9,5mm	A	-	-	MG-4290
	9,5mm	ASR	R11	C	MG-3960
	9,5mm	NR	R10	B	MG-4695
	9,5mm	TC	-	-	MG-4695
60x120	9,5mm	A	-	-	MG-4970
	9,5mm	ASR	R11	C	MG-4695
120x120	9mm	NR	R10	B	MG-5450

metropolis

collection



30x60	8,5mm	NR	R10	B	MG-2095
	8,5mm	NR	R10	B	MG-2765
60x60	8,5mm	TC	-	-	MG-2765
	NEW 8,5mm	ASR	R11	C	MG-2765
	9,5mm	NR	R10	B	MG-3960
	9,5mm	TC	-	-	MG-3960
90x90	9,5mm	A	-	-	MG-4290
	9,5mm	ASR	R11	C	MG-3960
	9,5mm	NR	R10	B	MG-4695
	9,5mm	TC	-	-	MG-4695
60x120	9,5mm	A	-	-	MG-4970
	9,5mm	ASR	R11	C	MG-4695
120x120	9mm	NR	R10	B	MG-5450



30x60	8,5mm	NR	R10	B	MG-2095
	8,5mm	NR	R10	B	MG-2765
60x60	8,5mm	TC	-	-	MG-2765
	NEW 8,5mm	ASR	R11	C	MG-2765
	9,5mm	NR	R10	B	MG-3960
	9,5mm	TC	-	-	MG-3960
90x90	9,5mm	A	-	-	MG-4290
	9,5mm	ASR	R11	C	MG-3960
	9,5mm	NR	R10	B	MG-4695
	9,5mm	TC	-	-	MG-4695
60x120	9,5mm	A	-	-	MG-4970
	9,5mm	ASR	R11	C	MG-4695
120x120	9mm	NR	R10	B	MG-5450

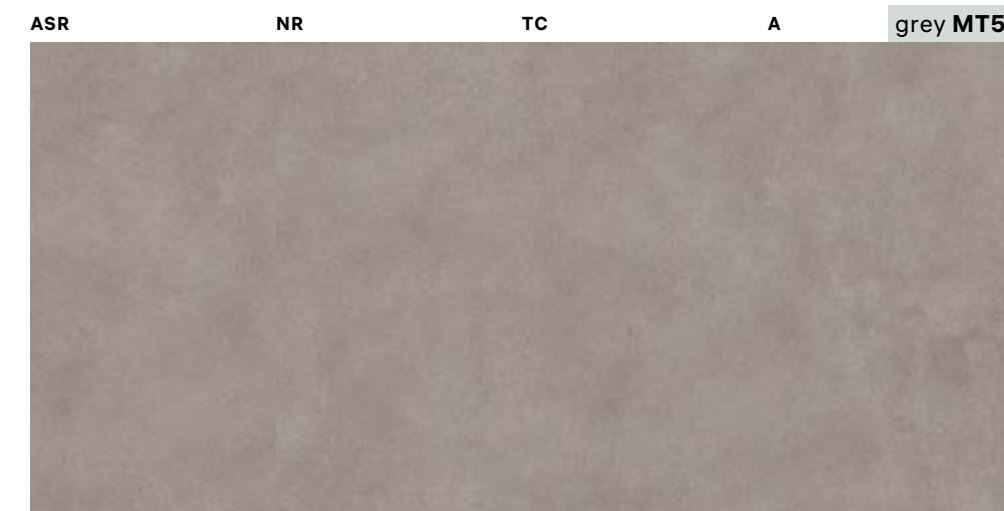

30x60	8,5mm	NR	R10	B	MG-2095
	8,5mm	NR	R10	B	MG-2765
60x60	8,5mm	TC	-	-	MG-2765
	NEW 8,5mm	ASR	R11	C	MG-2765
	9,5mm	NR	R10	B	MG-3960
	9,5mm	TC	-	-	MG-3960
90x90	9,5mm	A	-	-	MG-4290
	9,5mm	ASR	R11	C	MG-3960
	9,5mm	NR	R10	B	MG-4695
	9,5mm	TC	-	-	MG-4695
60x120	9,5mm	A	-	-	MG-4970
	9,5mm	ASR	R11	C	MG-4695
120x120	9mm	NR	R10	B	MG-5450

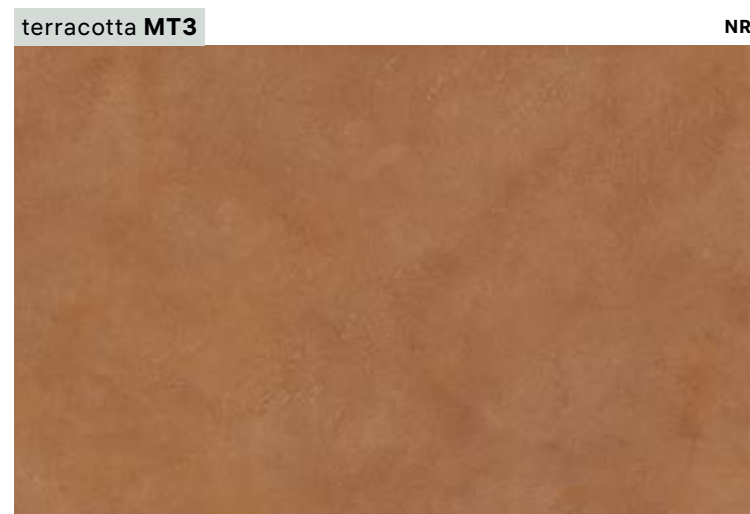

90x90	9,5mm	NR	R10	B	MG-3960
60x120	9,5mm	NR	R10	B	MG-4695

index

colour map

collections

bare&bold

concept

deck plus

endless

evoke

evolution

fragment

grove

hybrid

metropolis

prestige

pure stone

slabstone

stage

subway

tecnica

thunder

time 2.0

tool

linea collections

useful information

PROTECT

Antibacterial for Life.

MARGRES
CERAMIC TILES

An exclusive line of extremely high performance antimicrobial floor and wall tiles, designed for healthy, safe and protected living spaces. Anti-slip finish doesn't have antibacterial protection.
Une ligne exclusive de sols et revêtements antibactériens aux performances très élevées, pour un habitat sain, sûr et protégé. La finition antidérapante n'a pas de protection antibactérienne.
Eine exklusive Linie an hochwertigen Fußböden und antibakteriellen Wandverkleidungen, für ein gesundes, sicheres und geschütztes Leben. Die rutschfeste Oberfläche hat keinen antibakteriellen Schutz.
Uma linha exclusiva de pavimentos e revestimentos antimicrobianos de altíssima performance, projetada para ambientes saudáveis, seguros e protegidos. O acabamento antiderrapante não tem proteção antibacteriana.



106

general catalogue . 2026

beige MT2 90x90 NR . terracotta MT3 90x90 NR

decors

décorations . dekorationen . decorações

9,5MM

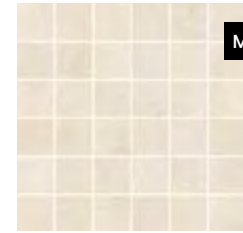

mosaic metropolis 5x5 white
30x30
A MG-9745



mosaic metropolis 5x5 beige
30x30
A MG-9745

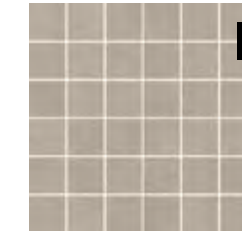

mosaic metropolis 5x5 light grey
30x30
A MG-9745

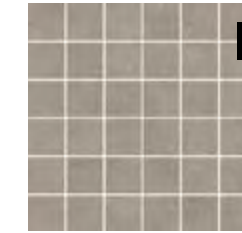

mosaic metropolis 5x5 grey
30x30
A MG-9745

listel brushed gold*
1x1x120
MP-6500

listel brushed silver*
1x1x120
MP-6520

listel brushed copper*
1x1x120
MP-6560

Mosaic decor is net mounted. All decors may feature shade variations regarding the corresponding floor/wall tile standard tile.
 La décoration Mosaic est sur trame. Toutes les décorations peuvent souffrir variations de tonalité par rapport aux carreaux base.
 Die Mosaic Dekoration ist netzverklebt. Alle Dekorationen können im Vergleich zu den jeweiligen Grundiesen Farbunterschiede aufweisen.
 A decoração Mosaic é sobre rede. Todas as decorações podem sofrer variações de tonalidade em relação aos respectivos mosaicos base.

*
 Decorative pieces with precious metals are sensitive to acid attacks. For further information on cleaning metallic decorations – Gold, Silver and Copper – please see section 08 from page 357.
 Les pièces décoratives en métaux précieux sont sensibles aux attaques d'acides. Pour des informations concernant le nettoyage des décors métalliques – Gold, Silver et Copper – veuillez consulter le point 08 à la page 357.
 Dekorative teile mit Edelmetallen sind gegen Säure empfindlich. Informationen zur Reinigung der Metalldekorationen – Gold, Silver und Copper – finden Sie in Punkt 08 auf Seite 357.
 Peças decorativas com metais preciosos são sensíveis aos ataques ácidos. Para informações sobre limpeza das decorações metálicas – Gold, Silver e Copper – por favor consulte o ponto 08 da página 357.

bare&bold

concept

deck plus

endless

evoke

evolution

fragment

grove

hybrid

metropolis

prestige

pure stone

slabstone

stage

subway

tecnica

thunder

time 2.0

tool

107

general catalogue . 2026

metropolis

collection

decors

décorations . dekorationen . decorações

9,5MM



capital white *
30x120

A MP-6415



capital beige *
30x120

A MP-6415

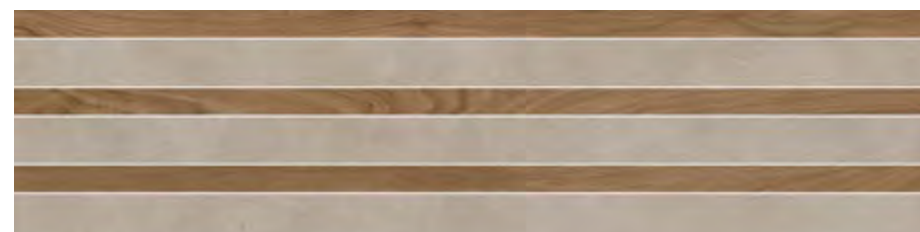

capital light grey **
30x120

A MP-6415



capital grey **
30x120

A MP-6415

Capital decor is net mounted. All decors may feature shade variations regarding the corresponding floor/wall tile standard tile.
La décoration Capital est sur trame. Toutes les décorations peuvent souffrir variations de tonalité par rapport aux carreaux base.
Die Capital Dekoration ist netzverklebt. Alle Dekorationen können im Vergleich zu den jeweiligen Grundiesen Farbunterschiede aufweisen.
A decoração Capital é sobre rede. Todas as decorações podem sofrer variações de tonalidade em relação aos respectivos mosaicos base.

metropolis

collection

special pieces

pièces spéciales . spezialteile . peças especiais

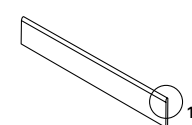

skirting
plinthe
sockel
rodapé

8x60

NR . TC MP-6170

8x90

NR . TC MP-6260

A MP-6270

8x120

NR . TC MP-6260

A MP-6270

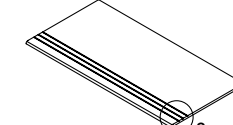

step tread grooved
nez de marche creusé
stufenplatte mit rillen
degrau sulcado

30x60

NR . TC . ASR MP-6240

30x90

NR . TC . ASR MP-6430

A MP-6445

30x120

NR . TC . ASR MP-6445

A MP-6470

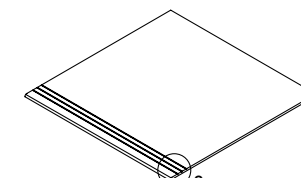

step tread grooved
nez de marche creusé
stufenplatte mit rillen
degrau sulcado

60x60

NR . TC . ASR MP-6400

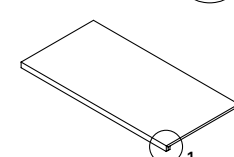
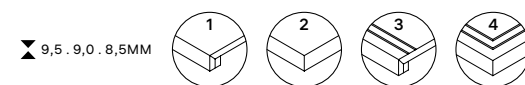

step tread "L"
nez de marche "L"
stufenplatte "L"
degrau "L"

30x60

NR . TC . ASR MP-6560

30x90

NR . TC . A . ASR MP-6590

30x120

NR . TC . A . ASR MP-6595

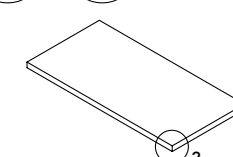

* step tread "L" corner
nez de marche "L" angle
ecke stufenplatte "L"
degrau "L" canto

30x60

NR . TC . ASR MP-6630

30x90

NR . TC . A . ASR MP-6645

30x120

NR . TC . A . ASR MP-6655

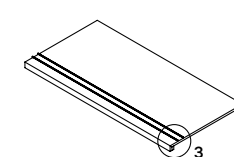

step tread "L" inox
nez de marche "L" inox
stufenplatte "L" inox
degrau "L" inox

30x60

NR . TC MP-6580

30x90

NR . TC . A MP-6640

30x120

NR . TC . A MP-6670

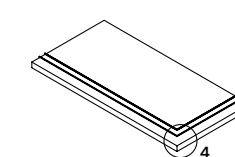

* step tread "L" corner inox
nez de marche "L" angle inox
ecke stufenplatte "L" inox
degrau "L" canto inox

30x60

NR . TC MP-6650

30x90

NR . TC . A MP-6690

30x120

NR . TC . A MP-6710

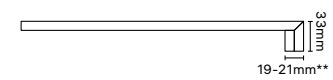

step tread "L" corner . nez de marche "L" angle
ecke stufenplatte "L" . degrau "L" canto

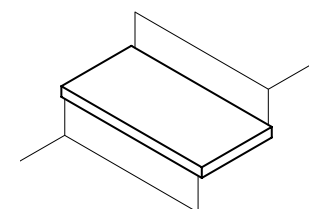

right corner . angle droit
rechten ecke . canto direito

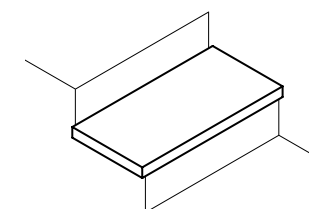

left corner . angle gauche
links ecke . canto esquerdo

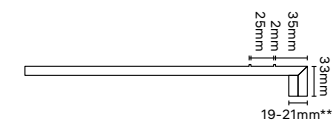

step tread "L" corner inox . nez de marche "L" angle inox
ecke stufenplatte "L" inox . degrau "L" canto inox

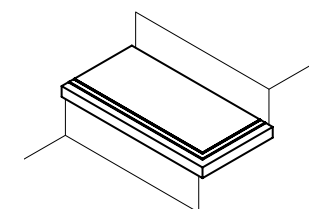

right corner . angle droit
rechten ecke . canto direito

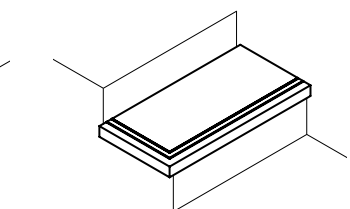

left corner . angle gauche
links ecke . canto esquerdo

*
Wood insert: Stage Beige
Insert Bois: Stage Beige
Holzprofil eingefügt: Stage Beige
Inserto de madeira: Stage Beige

**
Wood insert: Stage Brown
Insert Bois: Stage Brown
Holzprofil eingefügt: Stage Brown
Inserto de madeira: Stage Brown

Available in all colours
Disponible dans toutes les couleurs
Erhältlich in allen Farben
Disponível em todas as cores

*
Available in right and left corner
Disponible dans les coin droit et gauche
Erhältlich in der rechten Ecke und links
Disponível no canto direito e esquerdo

**
Dimension will vary depending on the base tile thickness.
La dimension varie selon l'épaisseur du carreau.
Das Maß variiert je nach Dicke der Fliese.
A dimensão varia consoante a espessura do material cerâmico.

MARGRES
CERAMIC TILES

index

colour map

collections

bare&bold

concept

deck plus

endless

evoke

evolution

fragment

grove

hybrid

metropolis

prestige

pure stone

slabstone

stage

subway

tecnica

thunder

time 2.0

tool

linea collections

useful information



beige SE2 20X120 A

DIGITEK
PORCELAIN
STONEWARE

stage
collection —

↓
DOWNLOAD
CATALOGUE

↓
DOWNLOAD
TECHNICAL
FEATURES

🌐
VIEW
ONLINE



60x120
A 9,5mm



20x120
NR 9,5mm
A 9,5mm

rectified products . produits rectifiés . rektifizierte produkte . produtos retificados

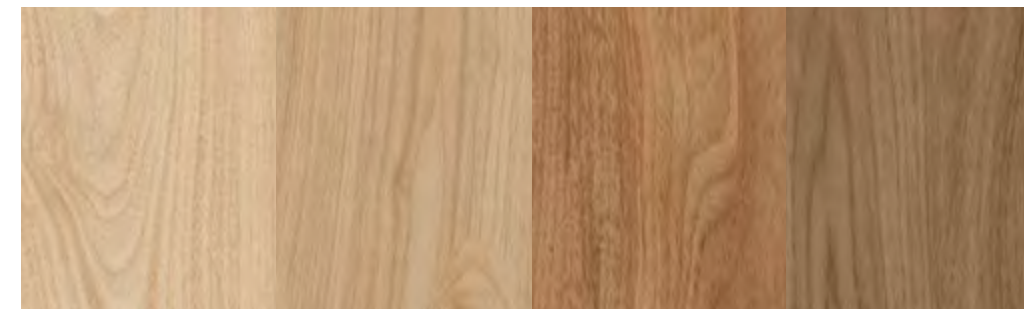

cream
SE1

beige
SE2

cherry
SE4

brown
SE5

UGL V2 R10 
NR

PR()TECT®
Antibacterial for Life.

MARGRES
CERAMIC TILES

index —

colour map —

collections —

- bare&bold
- concept
- deck plus
- endless
- evoke
- evolution
- fragment
- grove
- hybrid
- metropolis
- prestige
- pure stone
- slabstone
- stage**
- subway
- tecnica
- thunder
- time 2.0
- tool

linea collections —

useful information —

stage

— collection



112

general catalogue, 2026

cream SE1 20X120 A

stage

collection —



113

general catalogue, 2026

cream SE1 20X120 NR

index



colour map



collections



bare&bold

concept

deck plus

endless

evoke

evolution

fragment

grove

hybrid

metropolis

prestige

pure stone

slabstone

stage



subway

tecnica

thunder

time 2.0

tool

linea collections



useful information



stage

— collection



114

general catalogue . 2026

cherry SE4 20x120 NR



115

general catalogue . 2026

chevron cherry 20X100 A

index



colour map



collections



bare&bold

concept

deck plus

endless

evoke

evolution

fragment

grove

hybrid

metropolis

prestige

pure stone

slabstone

stage

subway

tecnica

thunder

time 2.0

tool

linea collections



useful information



collections

- bare&bold
- concept
- deck plus
- endless
- evoke
- evolution
- fragment
- grove
- hybrid
- metropolis
- prestige
- pure stone
- slabstone
- stage**
- subway
- tecnica
- thunder
- time 2.0
- tool



116

genera catalogue, 2026

117

genera catalogue, 2026

brown SE5 20x120 NR

stage
— collection

stage
collection —

index



colour map



collections



bare&bold

concept

deck plus

endless

evoke

evolution

fragment

grove

hybrid

metropolis

prestige

pure stone

slabstone

stage

subway

tecnica

thunder

time 2.0

tool

linea collections



useful information



118



general catalogue . 2026

119



general catalogue . 2026

STAGEWOOD
AUDITORIUM

brown SE5 60X120 A

stage

— collection



20x120	9,5mm	NR	R10	B	MG-1330
	9,5mm	A	-	-	MG-1450
60x120	9,5mm	A	-	-	MG-4950



20x120	9,5mm	NR	R10	B	MG-1330
	9,5mm	A	-	-	MG-1450
60x120	9,5mm	A	-	-	MG-4950

stage

collection —



20x120	9,5mm	NR	R10	B	MG-1330
	9,5mm	A	-	-	MG-1450
60x120	9,5mm	A	-	-	MG-4950



20x120	9,5mm	NR	R10	B	MG-1330
	9,5mm	A	-	-	MG-1450
60x120	9,5mm	A	-	-	MG-4950

index

colour map

collections

bare&bold

concept

deck plus

endless

evoke

evolution

fragment

grove

hybrid

metropolis

prestige

pure stone

slabstone

stage

subway

tecnica

thunder

time 2.0

tool

120

121

general catalogue . 2026

general catalogue . 2026

MARGRES
CERAMIC TILES

PR()TECT®

Antibacterial for Life.

An exclusive line of extremely high performance antimicrobial floor and wall tiles, designed for healthy, safe and protected living spaces.
Une ligne exclusive de sols et revêtements antibactériens aux performances très élevées, pour un habitat sain, sûr et protégé.
Eine exklusive Linie an hochwertigen Fußböden und antibakteriellen Wandverkleidungen, für ein gesundes, sicheres und geschütztes Leben.
Uma linha exclusiva de pavimentos e revestimentos antimicrobianos de altíssima performance, projetada para ambientes saudáveis, seguros e protegidos.

linea collections

useful information

stage

collection

decors

décorations . dekorationen . decorações

9,5MM



chevron cream
20x100
NR MG-9525
A MG-9715



taco cream
6,5x40
A MG-9730



chevron beige
20x100
NR MG-9525
A MG-9715



taco beige
6,5x40
A MG-9730



chevron cherry
20x100
NR MG-9525
A MG-9715



taco cherry
6,5x40
A MG-9730



chevron brown
20x100
NR MG-9525
A MG-9715



taco brown
6,5x40
A MG-9730

special pieces

pièces spéciales . spezialteile . peças especiais

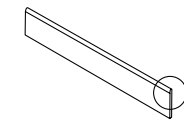

skirting
plinthe
sockel
rodapé
8x120
NR MP-6260
A MP-6270

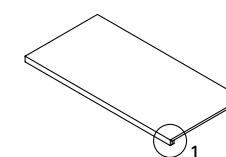
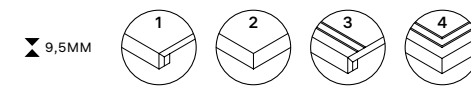

step tread "L"
nez de marche "L"
stufenplatte "L"
degrau "L"
30x120
NR . A MP-6595

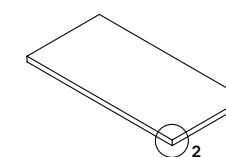

* step tread "L" corner
nez de marche "L" angle
ecke stufenplatte "L"
degrau "L" canto
30x120
NR . A MP-6655

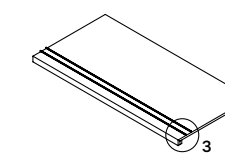

step tread "L" inox
nez de marche "L" inox
stufenplatte "L" inox
degrau "L" inox
30x120
NR . A MP-6670

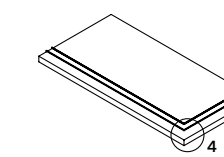

* step tread "L" corner inox
nez de marche "L" angle inox
ecke stufenplatte "L" inox
degrau "L" canto inox
30x120
NR . A MP-6710



step tread "L" corner . nez de marche "L" angle
ecke stufenplatte "L" . degrau "L" canto

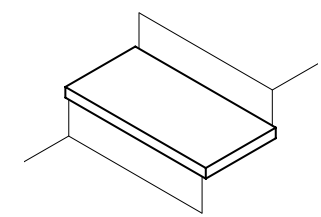

right corner . angle droit
rechten ecke . canto direito

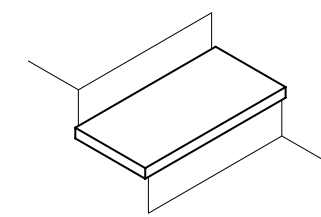

left corner . angle gauche
links ecke . canto esquerdo

step tread "L" corner inox . nez de marche "L" angle inox
ecke stufenplatte "L" inox . degrau "L" canto inox

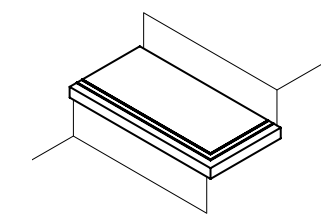

right corner . angle droit
rechten ecke . canto direito

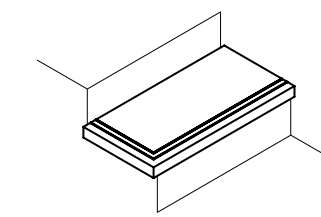

left corner . angle gauche
links ecke . canto esquerdo

Available in all colours
Disponible dans toutes les couleurs
Erhältlich in allen Farben
Disponível em todas as cores

* Available in right and left corner
Disponible dans les coin droit et gauche
Erhältlich in der rechten Ecke und links
Disponível no canto direito e esquerdo

stage

collection

index

colour map

collections

bare&bold

concept

deck plus

endless

evoke

evolution

fragment

grove

hybrid

metropolis

prestige

pure stone

slabstone

stage

subway

tecnica

thunder

time 2.0

tool

linea collections

useful information



Breccia capraia ED2 60x120 P

LAMINATED
PORCELAIN
STONEWARE

DIGITEK
PORCELAIN
STONEWARE

endless

collection



100x300
SM . P 5,5mm

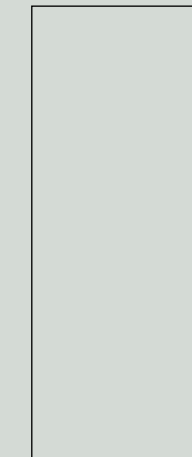

100x250
SM . P 5,5mm

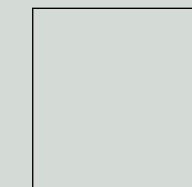

100x100
SM . P 5,5mm

↓
DOWNLOAD
CATALOGUE

↓
DOWNLOAD
TECHNICAL
FEATURES

↓
VIEW
ONLINE

↓
DOWNLOAD
BIM



60x120
SM . P 9,5mm



90x90
SM . ASR 9,5mm

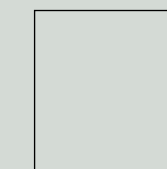

89x89
P 9,5mm

rectified products . produits rectifiés . rektifizierete produkte . produtos retificados

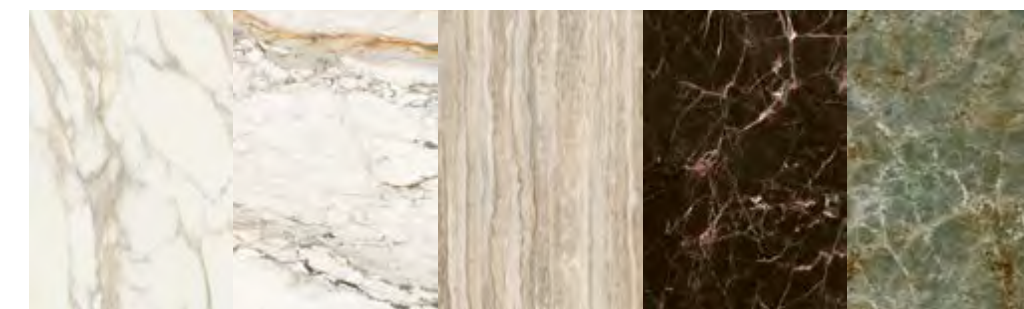

calacatta gold
ED1 . LED1

breccia capraia
ED2 . LED2

travertino
ED3 . LED3

port black
ED4 . LED4

amazonite
ED5 . LED5

UGL V2 R10
ASR SM P
ASR

BIM

PR()TECT®

Antibacterial for Life.

MARGRES
CERAMIC TILES

index

colour map

collections

bare&bold

concept

deck plus

endless

evoke

evolution

fragment

grove

hybrid

metropolis

prestige

pure stone

slabstone

stage

subway

tecnica

thunder

time 2.0

tool

linea collections

useful information



collections

- bare&bold
- concept
- deck plus
- endless**
- evoke
- evolution
- fragment
- grove
- hybrid
- metropolis
- prestige
- pure stone
- slabstone
- stage
- subway
- tecnica
- thunder
- time 2.0
- tool

collections

bare&bold

concept

deck plus

endless

evoke

evolution

fragment

grove

hybrid

metropolis

prestige

pure stone

slabstone

stage

subway

tecnica

thunder

time 2.0

tool

linea collections

useful information



endless

— collection



130

general catalogue, 2026

calacatta gold ED1 60x120 SM

endless

collection —



131

general catalogue, 2026

amazonite ED5 60x120 P

index



colour map



collections



bare&bold

concept

deck plus

endless

evoke

evolution

fragment

grove

hybrid

metropolis

prestige

pure stone

slabstone

stage

subway

tecnica

thunder

time 2.0

tool

linea collections



useful information



endless

— collection

calacatta gold ED1 . LED1

P

SM

ASR

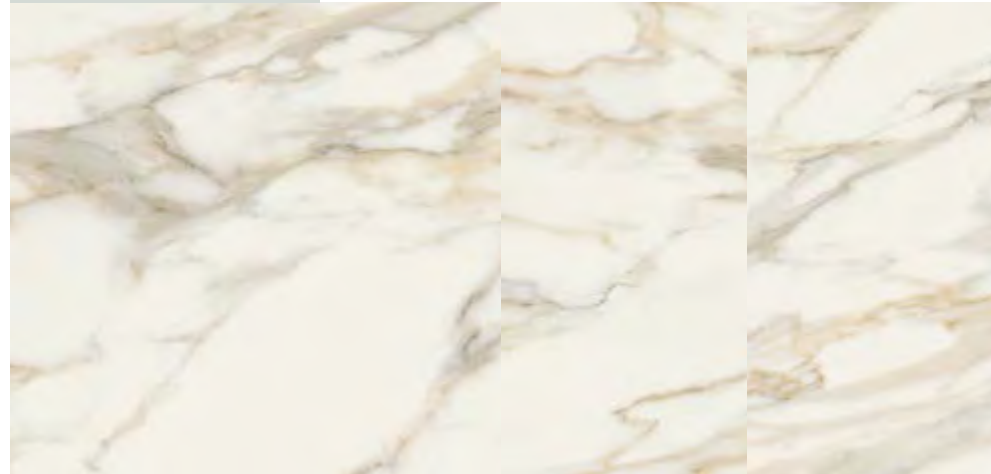

89x89	9,5mm	P	-	-	MG-4470
	9,5mm	SM	-	-	MG-3955
90x90	9,5mm	ASR	R10	B	MG-3955
	9,5mm	SM	-	-	MG-4680
60x120	9,5mm	P	-	-	MG-5160
	9,5mm	P	-	-	MG-5160
LINEA					
100x100	5,5mm	SM	-	-	M3-2730
	5,5mm	P	-	-	M3-3130
100x250	5,5mm	SM	-	-	M3-3530
	5,5mm	P	-	-	M3-3830
100x300	5,5mm	SM	-	-	M3-4230
	5,5mm	P	-	-	M3-4630

breccia capraia ED2 . LED2

P

SM

ASR



89x89	9,5mm	P	-	-	MG-4470
	9,5mm	SM	-	-	MG-3955
90x90	9,5mm	ASR	R10	B	MG-3955
	9,5mm	SM	-	-	MG-4680
60x120	9,5mm	P	-	-	MG-5160
	9,5mm	P	-	-	MG-5160
LINEA					
100x100	5,5mm	SM	-	-	M3-2730
	5,5mm	P	-	-	M3-3130
100x250	5,5mm	SM	-	-	M3-3530
	5,5mm	P	-	-	M3-3830
100x300	5,5mm	SM	-	-	M3-4230
	5,5mm	P	-	-	M3-4630

travertino ED3 . LED3

P

SM

ASR



89x89	9,5mm	P	-	-	MG-4470
	9,5mm	SM	-	-	MG-3955
90x90	9,5mm	ASR	R10	B	MG-3955
	9,5mm	SM	-	-	MG-4680
60x120	9,5mm	P	-	-	MG-5160
	9,5mm	P	-	-	MG-5160
LINEA					
100x100	5,5mm	SM	-	-	M3-2730
	5,5mm	P	-	-	M3-3130
100x250	5,5mm	SM	-	-	M3-3530
	5,5mm	P	-	-	M3-3830
100x300	5,5mm	SM	-	-	M3-4230
	5,5mm	P	-	-	M3-4630

89x89	9,5mm	P	-	-	MG-4470
	9,5mm	P	-	-	MG-5160
LINEA					
100x100	5,5mm	P	-	-	M3-3130
	5,5mm	P	-	-	M3-3830
100x300	5,5mm	P	-	-	M3-4630

89x89	9,5mm	P	-	-	MG-4470
	9,5mm	P	-	-	MG-5160
LINEA					
100x100	5,5mm	P	-	-	M3-3130
	5,5mm	P	-	-	M3-3830
100x300	5,5mm	P	-	-	M3-4630

endless

— collection

port black ED4 . LED4

P

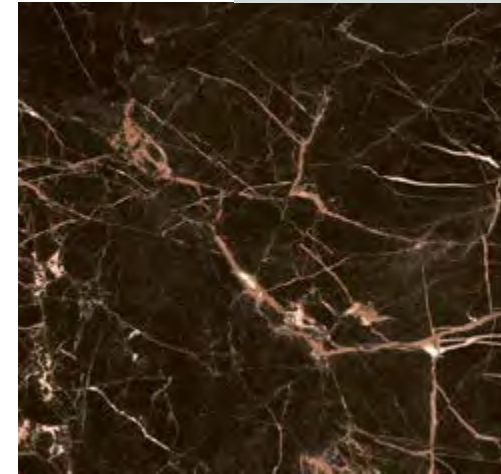

P

amazonite ED5 . LED5

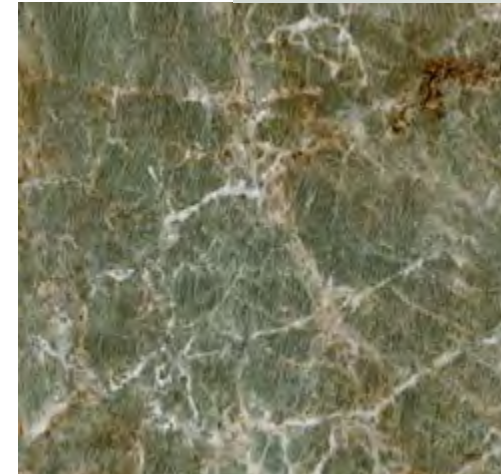

index

colour map

collections

bare&bold

concept

deck plus

endless

evoke

evolution

fragment

grove

hybrid

metropolis

prestige

pure stone

slabstone

stage

subway

tecnica

thunder

time 2.0

tool

Products with a polished finish are more sensitive to abrasion and stains, what requires special conditions. Please see page 358 in chapter 09.
Les produits à finition polie sont plus sensibles à l'abrasion et aux taches, ce qui requiert des conditions particulières. Veuillez-vous consulter la page 358 du chapitre 09.
Produkte mit einer polierten Oberfläche sind empfindlicher gegen Abrieb und Fleckenbildung, was besondere Bedingungen erfordert. Bitte beachten Sie Seite 358 in Kapitel 09.
Os produtos com acabamento polido são mais sensíveis à abrasão e às manchas, o que requer condições especiais. Por favor consulte a página 358 no capítulo 09.

PROTECT

Antibacterial for Life.

MARGRES
CERAMIC TILES

An exclusive line of extremely high performance antimicrobial floor and wall tiles, designed for healthy, safe and protected living spaces. Anti-slip finish doesn't have antibacterial protection.
Une ligne exclusive de sols et revêtements antibactériens aux performances très élevées, pour un habitat sain, sûr et protégé. La finition antidérapante n'a pas de protection antibactérienne.
Eine exklusive Linie an hochwertigen Fußböden und antibakteriellen Wandverkleidungen, für ein gesundes, sicheres und geschütztes Leben. Die rutschfeste Oberfläche hat keinen antibakteriellen Schutz.
Uma linha exclusiva de pavimentos e revestimentos antimicrobianos de altíssima performance, projetada para ambientes saudáveis, seguros e protegidos. O acabamento antiderrapante não tem proteção antibacteriana.

linea collections

useful information

endless

collection

decors

décorations . dekorationen . decorações

9,5MM



mosaic endless 3,5x3,5
calacatta gold
30x30
SM MG-9580
P MG-9830



mosaic endless 3,5x3,5
breccia capraia
30x30
SM MG-9580
P MG-9830

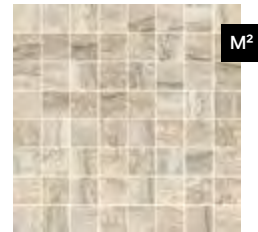

mosaic endless 3,5x3,5
travertino
30x30
SM MG-9580
P MG-9830



mosaic endless 3,5x3,5
port black
30x30
P MG-9830

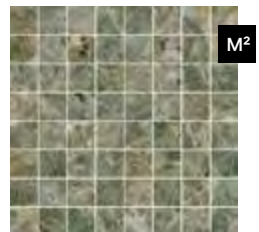

mosaic endless 3,5x3,5
amazonite
30x30
P MG-9830

special pieces

pièces spéciales . spezialteile . peças especiais

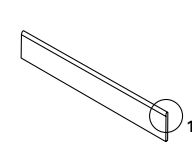
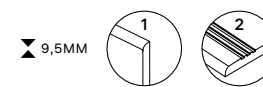

skirting
plinthe
sockel
rodapé

8x89
P MP-6270
8x90
SM MP-6260
8x120
SM MP-6260
P MP-6270

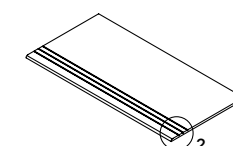

step tread grooved
nez de marche creusé
stufenplatte mit rillen
degrau sulcado

30x89
P MP-6445
30x90
SM . ASR MP-6430
30x120
SM MP-6445
P MP-6470

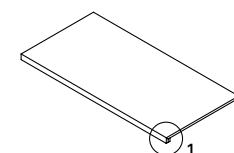
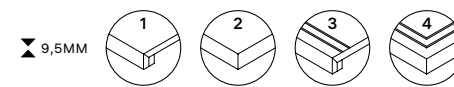

step tread "L"
nez de marche "L"
stufenplatte "L"
degrau "L"

30x89
P MP-6590
30x90
SM . ASR MP-6590
30x120
SM . P MP-6595

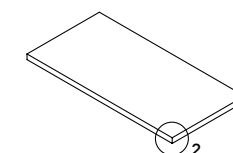

*
step tread "L" corner
nez de marche "L" angle
ecke stufenplatte "L"
degrau "L" canto

30x89
P MP-6650
30x90
SM . ASR MP-6645
30x120
SM . P MP-6655



step tread "L" corner . nez de marche "L" angle
ecke stufenplatte "L" . degrau "L" canto

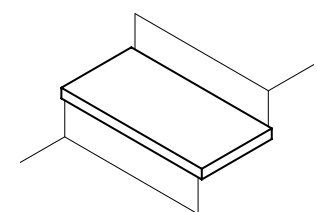

right corner . angle droit
rechten ecke . canto direito

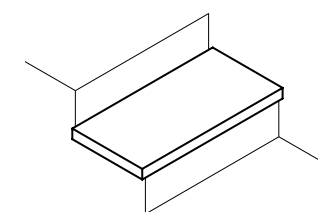

left corner . angle gauche
links ecke . canto esquerdo

Available in all colours
Disponible dans toutes les couleurs
Erhältlich in allen Farben
Disponível em todas as cores

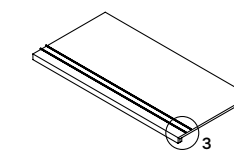

step tread "L" inox
nez de marche "L" inox
stufenplatte "L" inox
degrau "L" inox

30x89
P MP-6640
30x90
SM MP-6640
30x120
SM . P MP-6670

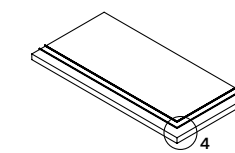

*
step tread "L" corner inox
nez de marche "L" angle inox
ecke stufenplatte "L" inox
degrau "L" canto inox

30x89
P MP-6690
30x90
SM MP-6690
30x120
SM . P MP-6710

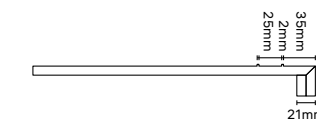

step tread "L" corner inox . nez de marche "L" angle inox
ecke stufenplatte "L" inox . degrau "L" canto inox

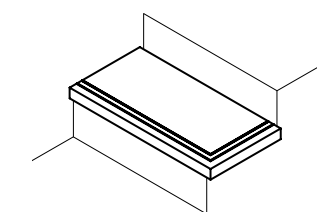

right corner . angle droit
rechten ecke . canto direito

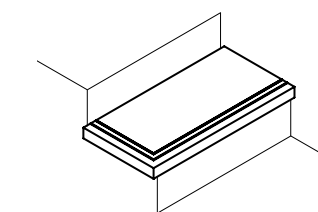

left corner . angle gauche
links ecke . canto esquerdo

*
Available in right and left corner
Disponible dans les coin droit et gauche
Erhältlich in der rechten Ecke und links
Disponível no canto direito e esquerdo

endless

collection

index

colour map

collections

bare&bold

concept

deck plus

endless

evoke

evolution

fragment

grove

hybrid

metropolis

prestige

pure stone

slabstone

stage

subway

tecnica

thunder

time 2.0

tool

linea collections

useful information



136

general catalogue . 2026

grey PS4 120x120 NR

LAMINATED
PORCELAIN
STONEWARE

FULL BODY
PORCELAIN

pure stone

collection

100x300 NR 6mm

100x250 NR 6mm

100x100 NR 6mm

120x120 NR . A 9,0mm

60x120 NR . A 9,5mm ASR 9,5mm E ASR 20mm

90x90 NR . A 9,5mm ASR 9,5mm ASR FLAT 9,5mm

60x60 NR . A 8,5mm ASR 8,5mm

30x60 NR . A 8,5mm

rectified products . produits rectifiés . rektifizierete produkte . produtos retificados

- ↓ DOWNLOAD CATALOGUE
- ↓ DOWNLOAD TECHNICAL FEATURES
- 🌐 VIEW ONLINE
- ↓ DOWNLOAD BIM
- ↓ DOWNLOAD CATALOGUE OUTDOOR EXTRA THICK



white PS1 . LPS1 beige PS2 . LPS2 light grey PS3 . LPS3 grey PS4 . LPS4 forge white LPS1F forge light grey LPS3F

UGL V2 R11 R10 R9

ASR FORGE NR LINEA NR
E ASR NR
ASR FLAT

BIM



PROTECT
Antibacterial for Life.

pour plus d'informations, consultez
<https://evaluation.cstb.fr>

MARGRES
CERAMIC TILES

index

colour map

collections

- bare&bold
- concept
- deck plus
- endless
- evoke
- evolution
- fragment
- grove
- hybrid
- metropolis
- prestige
- pure stone**
- slabstone
- stage
- subway
- tecnica
- thunder
- time 2.0
- tool

linea collections

useful information

137

general catalogue . 2026



bare&bold

concept

deck plus

endless

evoke

evolution

fragment

grove

hybrid

metropolis

prestige

pure stone

slabstone

stage

subway

tecnica

thunder

time 2.0

tool



light grey PS3 120x120 NR

pure stone

— collection

pure stone

collection —



140

general catalogue 2020

141

general catalogue 2020

beige PS2 90x90 NR

index



colour map



collections



bare&bold

concept

deck plus

endless

evoke

evolution

fragment

grove

hybrid

metropolis

prestige

pure stone

slabstone

stage

subway

tecnica

thunder

time 2.0

tool

linea collections



useful information



pure stone

— collection



white PS1 90x90 NR . grey PS4 NR . listel brushed gold 1x120

142

general catalogue . 2026

pure stone

collection —



light grey PS3 60x120 A . 60x60 A . listel brushed copper 1x120

143

general catalogue . 2026

index



colour map



collections



bare&bold

concept

deck plus

endless

evoke

evolution

fragment

grove

hybrid

metropolis

prestige

pure stone

slabstone

stage

subway

tecnica

thunder

time 2.0

tool

linea collections



useful information



pure stone

— collection



144

general catalogue . 2026

pure stone

collection —



light grey P53 90x90 A . mosaic circles white light grey 28x31,5 A

index



colour map



collections



bare&bold

concept

deck plus

endless

evoke

evolution

fragment

grove

hybrid

metropolis

prestige

pure stone

slabstone

stage

subway

tecnica

thunder

time 2.0

tool

linea collections



useful information



pure stone

— collection



chevron grey 48x64 A

146

general catalogue, 2026



pure stone

— collection

white PS1 120x120 NR

147

general catalogue, 2026

index



colour map



collections



bare&bold

concept

deck plus

endless

evoke

evolution

fragment

grove

hybrid

metropolis

prestige

pure stone

slabstone

stage

subway

tecnica

thunder

time 2.0

tool

linea collections



useful information



collections

- bare&bold
- concept
- deck plus
- endless
- evoke
- evolution
- fragment
- grove
- hybrid
- metropolis
- prestige
- pure stone**
- slabstone
- stage
- subway
- tecnica
- thunder
- time 2.0
- tool

pure stone

collection

white **PS1 . LPS1** A NR ASR FLAT ASR . E ASR



30x60	8,5mm	NR	R10	B	MG-2095
	8,5mm	A	-	-	MG-2370
60x60	8,5mm	NR	R10	B	MG-2765
	8,5mm	A	-	-	MG-3080
	8,5mm	ASR	R11	C	MG-2765
90x90	9,5mm	NR	R10	B	MG-3960
	9,5mm	A	-	-	MG-4290
	9,5mm	ASR	R11	C	MG-3960
	9,5mm	ASR FLAT	R11	C	MG-3960
60x120	9,5mm	NR	R10	B	MG-4695
	9,5mm	A	-	-	MG-4970
	9,5mm	ASR	R11	C	MG-4695
	20mm	E ASR	R11	C	MG-7490
120x120	9mm	NR	R10	B	MG-5450
	9mm	A	-	-	MG-5700
LINEA					
100x100	6mm	NR	R9	-	M3-6230
100x250	6mm	NR	R9	-	M3-7300
100x300	6mm	NR	R9	-	M3-7730

beige **PS2 . LPS2** A NR ASR FLAT ASR . E ASR



30x60	8,5mm	NR	R10	B	MG-2095
	8,5mm	A	-	-	MG-2370
60x60	8,5mm	NR	R10	B	MG-2765
	8,5mm	A	-	-	MG-3080
	8,5mm	ASR	R11	C	MG-2765
90x90	9,5mm	NR	R10	B	MG-3960
	9,5mm	A	-	-	MG-4290
	9,5mm	ASR	R11	C	MG-3960
	9,5mm	ASR FLAT	R11	C	MG-3960
60x120	9,5mm	NR	R10	B	MG-4695
	9,5mm	A	-	-	MG-4970
	9,5mm	ASR	R11	C	MG-4695
	20mm	E ASR	R11	C	MG-7490
120x120	9mm	NR	R10	B	MG-5450
	9mm	A	-	-	MG-5700
LINEA					
100x100	6mm	NR	R9	-	M3-6230
100x250	6mm	NR	R9	-	M3-7300
100x300	6mm	NR	R9	-	M3-7730

light grey **PS3 . LPS3** A NR ASR FLAT ASR . E ASR



30x60	8,5mm	NR	R10	B	MG-2095
	8,5mm	A	-	-	MG-2370
60x60	8,5mm	NR	R10	B	MG-2765
	8,5mm	A	-	-	MG-3080
	8,5mm	ASR	R11	C	MG-2765
90x90	9,5mm	NR	R10	B	MG-3960
	9,5mm	A	-	-	MG-4290
	9,5mm	ASR	R11	C	MG-3960
	9,5mm	ASR FLAT	R11	C	MG-3960
60x120	9,5mm	NR	R10	B	MG-4695
	9,5mm	A	-	-	MG-4970
	9,5mm	ASR	R11	C	MG-4695
	20mm	E ASR	R11	C	MG-7490
120x120	9mm	NR	R10	B	MG-5450
	9mm	A	-	-	MG-5700
LINEA					
100x100	6mm	NR	R9	-	M3-6230
100x250	6mm	NR	R9	-	M3-7300
100x300	6mm	NR	R9	-	M3-7730

pure stone

collection

ASR . E ASR ASR FLAT NR A grey **PS4 . LPS4**

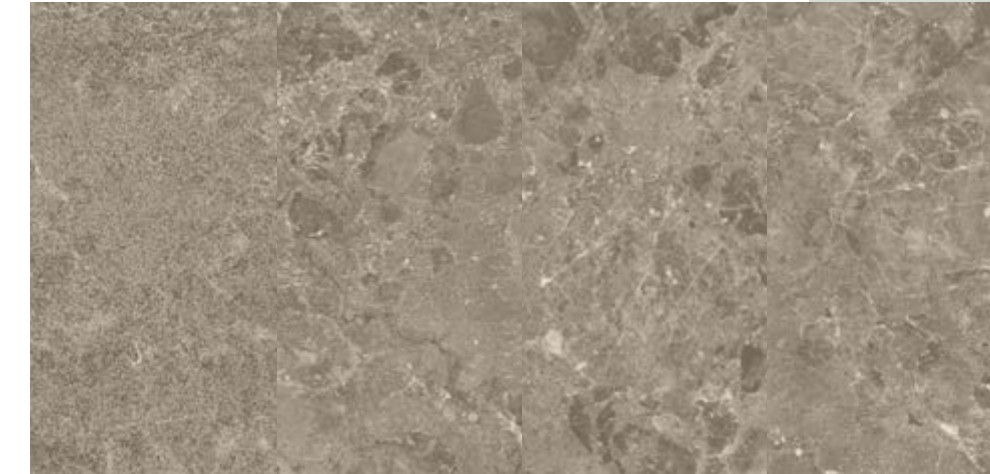

30x60	8,5mm	NR	R10	B	MG-2095
	8,5mm	A	-	-	MG-2370
60x60	8,5mm	NR	R10	B	MG-2765
	8,5mm	A	-	-	MG-3080
	8,5mm	ASR	R11	C	MG-2765
90x90	9,5mm	NR	R10	B	MG-3960
	9,5mm	A	-	-	MG-4290
	9,5mm	ASR	R11	C	MG-3960
	9,5mm	ASR FLAT	R11	C	MG-3960
60x120	9,5mm	NR	R10	B	MG-4695
	9,5mm	A	-	-	MG-4970
	9,5mm	ASR	R11	C	MG-4695
	20mm	E ASR	R11	C	MG-7490
120x120	9mm	NR	R10	B	MG-5450
	9mm	A	-	-	MG-5700
LINEA					
100x100	6mm	NR	R9	-	M3-6230
100x250	6mm	NR	R9	-	M3-7300
100x300	6mm	NR	R9	-	M3-7730

NR forge white **LPS1F**



LINEA					
100x100	6mm	NR	R10	-	M3-6230
100x250	6mm	NR	R10	-	M3-7300
100x300	6mm	NR	R10	-	M3-7730

NR forge light grey **LPS3F**



LINEA					
100x100	6mm	NR	R10	-	M3-6230
100x250	6mm	NR	R10	-	M3-7300
100x300	6mm	NR	R10	-	M3-7730

PROTECT

Antibacterial for Life.

An exclusive line of extremely high performance antimicrobial floor and wall tiles, designed for healthy, safe and protected living spaces. Anti-slip finish doesn't have antibacterial protection.
 Une ligne exclusive de sols et revêtements antibactériens aux performances très élevées, pour un habitat sain, sûr et protégé. La finition antidérapante n'a pas de protection antibactérienne.
 Eine exklusive Linie an hochwertigen Fußböden und antibakteriellen Wandverkleidungen, für ein gesundes, sicheres und geschütztes Leben. Die rutschfeste Oberfläche hat keinen antibakteriellen Schutz.
 Uma linha exclusiva de pavimentos e revestimentos antimicrobianos de altíssima performance, projetada para ambientes saudáveis, seguros e protegidos. O acabamento antiderrapante não tem proteção antibacteriana.

index

colour map

collections

bare&bold

concept

deck plus

endless

evoke

evolution

fragment

grove

hybrid

metropolis

prestige

pure stone

slabstone

stage

subway

tecnica

thunder

time 2.0

tool

linea collections

useful information

MARGRES
CERAMIC TILES



decors

décorations . dekorationen . decorações

8,5MM



mosaic pure stone 5x5
(all colours)
30x30
A MG-9745



bricks pure stone
(all colours)
30x60
A MP-6350

8,5MM



mosaic circles pure stone
5x5 white beige
28x31,5
A MP-6488



mosaic circles pure stone 5x5
white light grey
28x31,5
A MP-6488



mosaic circles pure stone
5x5 grey
28x31,5
A MP-6488

listel brushed gold*
1x1x120
MP-6500

listel brushed silver*
1x1x120
MP-6520

listel brushed copper*
1x1x120
MP-6560

*
Decorative pieces with precious metals are sensitive to acid attacks. For further information on cleaning metallic decorations – Gold, Silver and Copper – please see section 08 from page 357.
Les pièces décoratives en métaux précieux sont sensibles aux attaques d'acides. Pour des informations concernant le nettoyage des décors métalliques – Gold, Silver et Copper – veuillez consulter le point 08 à la page 357.
Dekorative teile mit Edelmetallen sind gegen Säure empfindlich. Informationen zur Reinigung der Metalldekorationen – Gold, Silver und Copper – finden Sie in Punkt 08 auf Seite 357.
Peças decorativas com metais preciosos são sensíveis aos ataques ácidos. Para informações sobre limpeza das decorações metálicas – Gold, Silver e Copper – por favor consulte o ponto 08 da página 357.

Mosaic and Brick decors are net mounted. All decors may feature shade variations regarding the corresponding floor/wall tile standard tile.
Les décorations Mosaic et Brick sont sur trame. Toutes les décorations peuvent souffrir variations de tonalité par rapport aux carreaux base.
Die Mosaik und Brick Dekoration liegen auf einem Netz. Alle Dekorationen können im Vergleich zu den jeweiligen Grundiesen Farbunterschiede aufweisen.
As decorações Mosaic and Brick são sobre rede. Todas as decorações podem sofrer variações de tonalidade em relação aos respectivos mosaicos base.

bare&bold

concept

deck plus

endless

evoke

evolution

fragment

grove

hybrid

metropolis

prestige

pure stone

slabstone

stage

subway

tecnica

thunder

time 2.0

tool

pure stone

collection

decors

décorations . dekorationen . decorações

8,5MM



Example of 4 pieces Mase 60x60 and Insert Pure Stone Silver 10x10 composition.
Exemple de composition avec 4 pièces Mase 60x60 et Insert Pure Stone Silver 10x10.
Ein Beispiel für die Zusammensetzung mit 4 Teilen Mase 60x60 und Insert Pure Stone Silver 10x10.
Exemplo de composição com 4 peças Mase 60x60 e Insert Pure Stone Silver 10x10.

mase pure stone (all colours)
60x60

A MG-9720



insert pure stone silver*
10x10
MP-6150

9,5MM



chevron pure stone (all colours)
48x64

A MG-9735

(sold per two pieces set_vendu à la paire_Paarweise verkauft_vendida ao par)

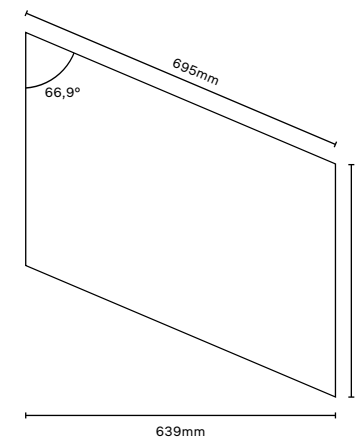

special pieces

pièces spéciales . spezialteile . peças especiais

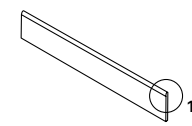

skirting
plinthe
socket
rodapé

8x60

NR MP-6170
A MP-6180

8x90

NR MP-6260
A MP-6270

8x120

NR MP-6260
A MP-6270

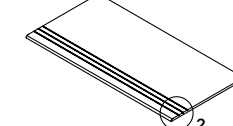

step tread grooved
nez de marche creusé
stufenplatte mit rillen
degrau sulcado

30x60

NR . ASR MP-6240
A MP-6270

30x90

NR . ASR MP-6430
A MP-6445

30x120

NR . ASR MP-6445
A MP-6470

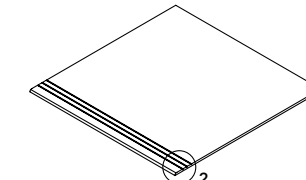

step tread grooved
nez de marche creusé
stufenplatte mit rillen
degrau sulcado

60x60

NR . ASR MP-6400
A MP-6430

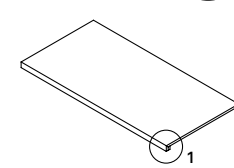
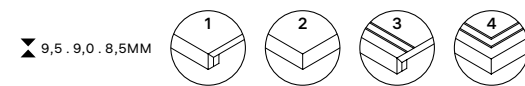

step tread "L"
nez de marche "L"
stufenplatte "L"
degrau "L"

30x60

NR . A . ASR MP-6560

30x90

NR . A . ASR MP-6590

30x120

NR . A . ASR MP-6595

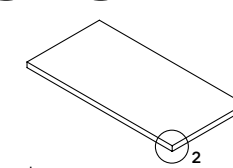

* step tread "L" corner
nez de marche "L" angle
ecke stufenplatte "L"
degrau "L" canto

30x60

NR . A . ASR MP-6630

30x90

NR . A . ASR MP-6645

30x120

NR . A . ASR MP-6655



step tread "L" corner . nez de marche "L" angle
ecke stufenplatte "L" . degrau "L" canto

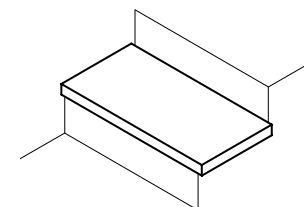

right corner . angle droit
rechten ecke . canto direito

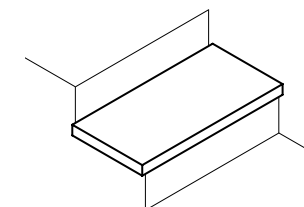

left corner . angle gauche
links ecke . canto esquerdo

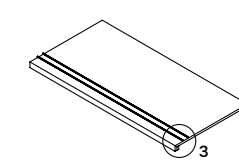

step tread "L" inox
nez de marche "L" inox
stufenplatte "L" inox
degrau "L" inox

30x60

NR . A MP-6580

30x90

NR . A MP-6640

30x120

NR . A MP-6670



step tread "L" corner inox . nez de marche "L" angle inox
ecke stufenplatte "L" inox . degrau "L" canto inox

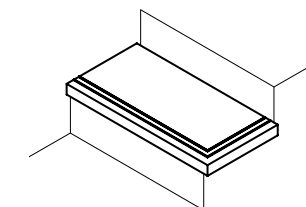

right corner . angle droit
rechten ecke . canto direito

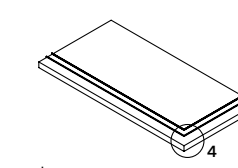

* step tread "L" corner inox
nez de marche "L" angle inox
ecke stufenplatte "L" inox
degrau "L" canto inox

30x60

NR . A MP-6650

30x90

NR . A MP-6690

30x120

NR . A MP-6710



step tread "L" corner inox . nez de marche "L" angle inox
ecke stufenplatte "L" inox . degrau "L" canto inox

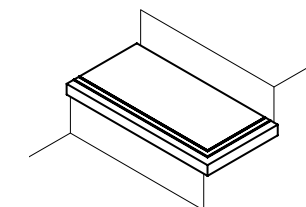

left corner . angle gauche
links ecke . canto esquerdo

* Decorative pieces with precious metals are sensitive to acid attacks.
Les pièces décoratives en métaux précieux sont sensibles aux attaques d'acides.
Dekorative teile mit Edelmetallen sind gegen Säure empfindlich.
Peças decorativas com metais preciosos são sensíveis aos ataques ácidos.

MARGRES
CERAMIC TILES

Available in all colours
Disponible dans toutes les couleurs
Erhältlich in allen Farben
Disponível em todas as cores

* Available in right and left corner
Disponible dans les coin droit et gauche
Erhältlich in der rechten Ecke und links
Disponível no canto direito e esquerdo

** Dimension will vary depending on the base tile thickness.
La dimension varie selon l'épaisseur du carreau.
Das Maß variiert je nach Dicke der Fliese.
A dimensão varia consoante a espessura do material cerâmico.

OUTDOOR

EXTRA THICK
Special 20MM pieces please refer to page 348.
Pièces spéciales 20MM, veuillez consulter la page 348.
Speziellanfertigungen 20MM siehe Seite 348.
Peças especiais 20MM, por favor consulte a página 348.

index

colour map

collections

bare&bold

concept

deck plus

endless

evoke

evolution

fragment

grove

hybrid

metropolis

prestige

pure stone

slabstone

stage

subway

tecnica

thunder

time 2.0

tool

linea collections

useful information

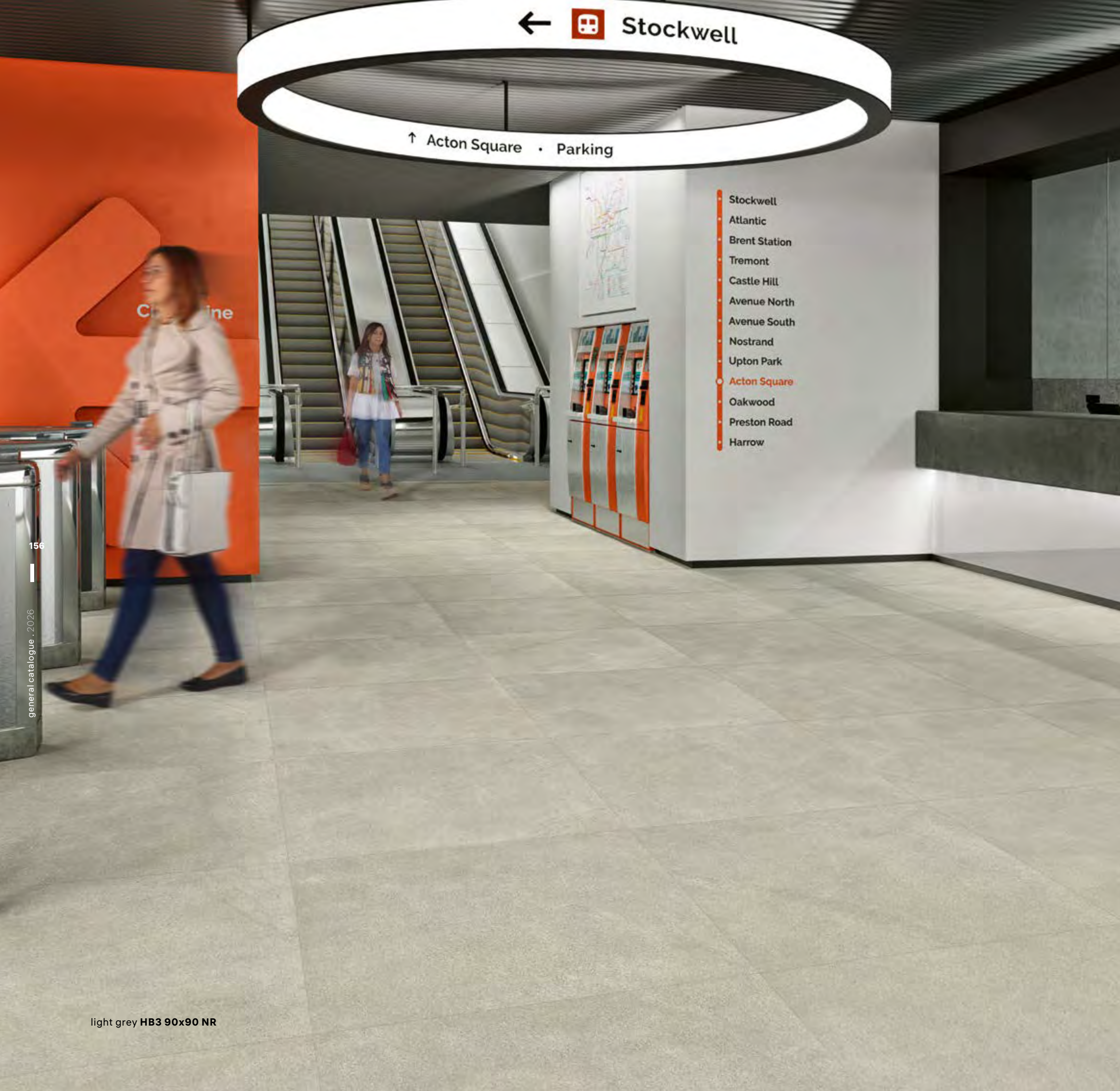

156

general catalogue . 2026

light grey HB3 90x90 NR

← Stockwell

↑ Acton Square · Parking

- Stockwell
- Atlantic
- Brent Station
- Tremont
- Castle Hill
- Avenue North
- Avenue South
- Nostrand
- Upton Park
- **Acton Square**
- Oakwood
- Preston Road
- Harrow

TECHNICAL
FULL BODY
PORCELAIN

hybrid

collection

ENJOY THE
VIDEO

DOWNLOAD
BIM

DOWNLOAD
CATALOGUE

DOWNLOAD
TECHNICAL
FEATURES

VIEW
ONLINE



60x120
NR 11mm
ASR 11mm

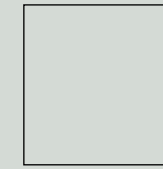

90x90
NR 11mm
ASR 11mm

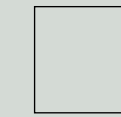

60x60
NR 10mm
ASR 10mm



30x60
NR 10mm
ASR 10mm

rectified products . produits rectifiés . rektifizierte produkte . produtos retificados



white
HB1

beige
HB2

light grey
HB3

tortora
HB4

black
HB5

UGL

V3

R11

R10



ASR

NR

BIM



pour plus d'informations, consultez
<https://evaluation.cstb.fr>

MARGRES
CERAMIC TILES

157

general catalogue . 2026

index

colour map

collections

bare&bold

concept

deck plus

endless

evoke

evolution

fragment

grove

hybrid

metropolis

prestige

pure stone

slabstone

stage

subway

tecnica

thunder

time 2.0

tool

linea collections

useful information



black HB5 90x90 NR

index

colour map

collections

bare&bold

concept

deck plus

endless

evoke

evolution

fragment

grove

hybrid

metropolis

prestige

pure stone

slabstone

stage

subway

tecnica

thunder

time 2.0

tool

linea collections

useful information

hybrid
collection



white HB1 60x60 NR



beige HB2 90x90 NR

index

colour map

collections

bare&bold

concept

deck plus

endless

evoke

evolution

fragment

grove

hybrid

metropolis

prestige

pure stone

slabstone

stage

subway

tecnica

thunder

time 2.0

tool

linea collections

useful information

160

general catalogue, 2026

161

general catalogue, 2026



hybrid
collection

162

general catalogue . 2026

tortora HB4 60x120 NR



hybrid
collection

163

general catalogue . 2026

tortora HB4 90x90 ASR

index

colour map

collections

bare&bold

concept

deck plus

endless

evoke

evolution

fragment

grove

hybrid

metropolis

prestige

pure stone

slabstone

stage

subway

tecnica

thunder

time 2.0

tool

linea collections

useful information

hybrid
collection



30x60	10mm	NR	R10	B	MG-2235
	10mm	ASR	R11	C	MG-2235
60x60	10mm	NR	R10	B	MG-2890
	10mm	ASR	R11	C	MG-2890
90x90	11mm	NR	R10	B	MG-4100
	11mm	ASR	R11	C	MG-4100
60x120	11mm	NR	R10	B	MG-4790
	11mm	ASR	R11	C	MG-4790



30x60	10mm	NR	R10	B	MG-2125
	10mm	ASR	R11	C	MG-2125
60x60	10mm	NR	R10	B	MG-2810
	10mm	ASR	R11	C	MG-2810
90x90	11mm	NR	R10	B	MG-4055
	11mm	ASR	R11	C	MG-4055
60x120	11mm	NR	R10	B	MG-4720
	11mm	ASR	R11	C	MG-4720

hybrid
collection



30x60	10mm	NR	R10	B	MG-2125
	10mm	ASR	R11	C	MG-2125
60x60	10mm	NR	R10	B	MG-2810
	10mm	ASR	R11	C	MG-2810
90x90	11mm	NR	R10	B	MG-4055
	11mm	ASR	R11	C	MG-4055
60x120	11mm	NR	R10	B	MG-4720
	11mm	ASR	R11	C	MG-4720



30x60	10mm	NR	R10	B	MG-2125
	10mm	ASR	R11	C	MG-2125
60x60	10mm	NR	R10	B	MG-2810
	10mm	ASR	R11	C	MG-2810
90x90	11mm	NR	R10	B	MG-4055
	11mm	ASR	R11	C	MG-4055
60x120	11mm	NR	R10	B	MG-4720
	11mm	ASR	R11	C	MG-4720

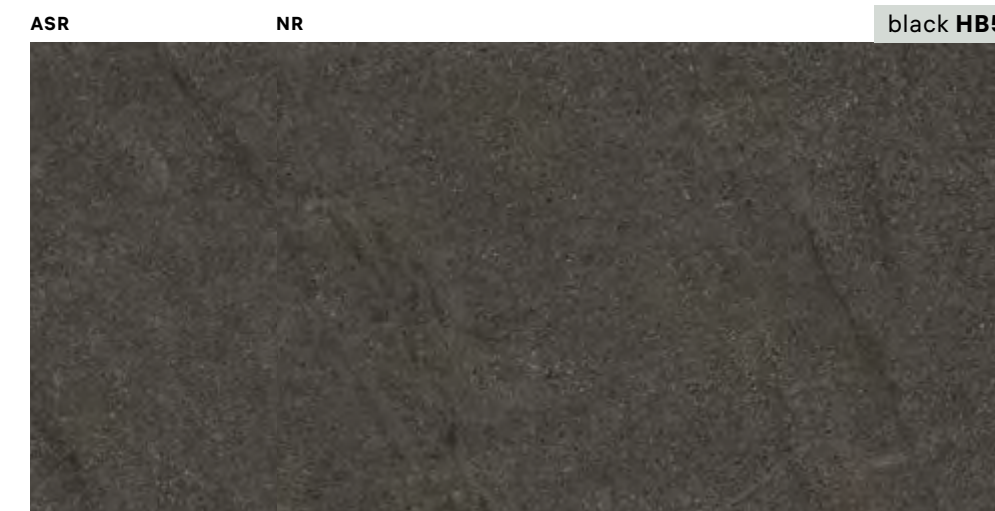

30x60	10mm	NR	R10	B	MG-2125
	10mm	ASR	R11	C	MG-2125
60x60	10mm	NR	R10	B	MG-2810
	10mm	ASR	R11	C	MG-2810
90x90	11mm	NR	R10	B	MG-4055
	11mm	ASR	R11	C	MG-4055
60x120	11mm	NR	R10	B	MG-4720
	11mm	ASR	R11	C	MG-4720

index

colour map

collections

- bare&bold
- concept
- deck plus
- endless
- evoke
- evolution
- fragment
- grove
- hybrid**
- metropolis
- prestige
- pure stone
- slabstone
- stage
- subway
- tecnica
- thunder
- time 2.0
- tool

linea collections

useful information

hybrid

collection

hybrid

collection

decors

décorations . dekorationen . decorações

10MM

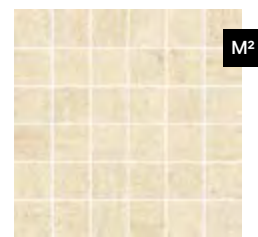

mosaic hybrid 5x5 white
30x30
NR MG-9570



mosaic hybrid 5x5 beige
30x30
NR MG-9570



mosaic hybrid 5x5 light grey
30x30
NR MG-9570



mosaic hybrid 5x5 tortora
30x30
NR MG-9570

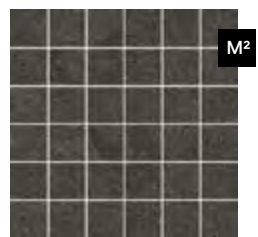

mosaic hybrid 5x5 black
30x30
NR MG-9570

10MM



bricks hybrid white
30x48
NR MP-6320



bricks hybrid beige
30x48
NR MP-6320



bricks hybrid light grey
30x48
NR MP-6320



bricks hybrid tortora
30x48
NR MP-6320



bricks hybrid black
30x48
NR MP-6320

special pieces

pièces spéciales . spezialteile . peças especiais

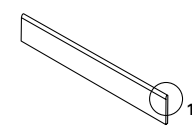
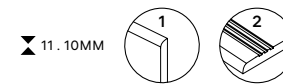

skirting
plinthe
sockel
rodapé
8x60
NR MP-6170
8x90
NR MP-6260
8x120
NR MP-6260

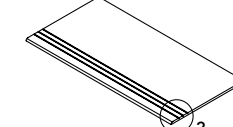

step tread grooved
nez de marche creusé
stufenplatte mit rillen
degrau sulcado
30x60
NR . ASR MP-6240
30x90
NR . ASR MP-6430
30x120
NR . ASR MP-6445

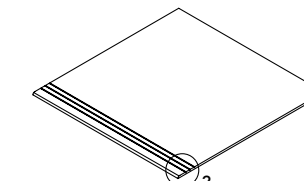

step tread grooved
nez de marche creusé
stufenplatte mit rillen
degrau sulcado
60x60
NR . ASR MP-6400

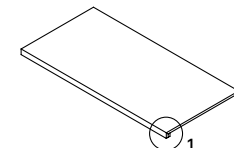
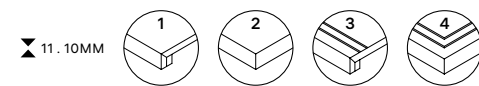

step tread "L"
nez de marche "L"
stufenplatte "L"
degrau "L"
30x60
NR MP-6560
30x120
NR MP-6595

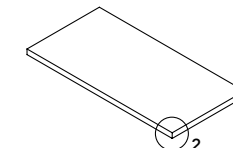

* step tread "L" corner
nez de marche "L" angle
ecke stufenplatte "L"
degrau "L" canto
30x60
NR MP-6630
30x120
NR MP-6655



step tread "L" corner . nez de marche "L" angle
ecke stufenplatte "L" . degrau "L" canto

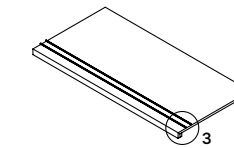

step tread "L" inox
nez de marche "L" inox
stufenplatte "L" inox
degrau "L" inox
30x60
NR MP-6580
30x120
NR MP-6670



step tread "L" corner inox . nez de marche "L" angle inox
ecke stufenplatte "L" inox . degrau "L" canto inox

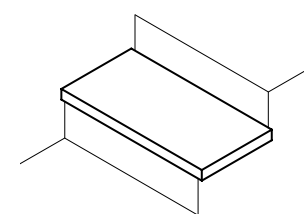

right corner . angle droit
rechten ecke . canto direito

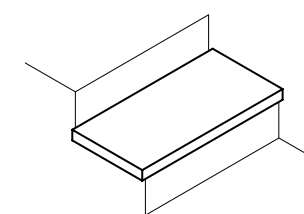

left corner . angle gauche
links ecke . canto esquerdo

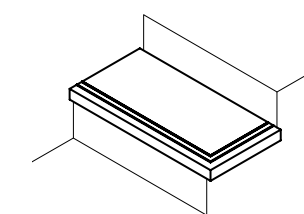

right corner . angle droit
rechten ecke . canto direito

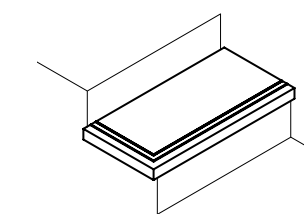

left corner . angle gauche
links ecke . canto esquerdo

Available in all colours
Disponible dans toutes les couleurs
Erhältlich in allen Farben
Disponível em todas as cores

* Available in right and left corner
Disponible dans les coin droit et gauche
Erhältlich in der rechten Ecke und links
Disponível no canto direito e esquerdo

** Dimension will vary depending on the base tile thickness.
La dimension varie selon l'épaisseur du carreau.
Das Maß variiert je nach Dicke der Fliese.
A dimensão varia consoante a espessura do material cerâmico.

index

colour map

collections

bare&bold

concept

deck plus

endless

evoke

evolution

fragment

grove

hybrid

metropolis

prestige

pure stone

slabstone

stage

subway

tecnica

thunder

time 2.0

tool

linea collections

useful information

Mosaic and Brick decors are net mounted. All decors may feature shade variations regarding the corresponding floor/wall tile standard tile.
Les décorations Mosaic et Brick sont sur trame. Toutes les décorations peuvent souffrir variations de tonalité par rapport aux carreaux base.
Die Mosaic und Brick Dekoration liegen auf einem Netz. Alle Dekorationen können im Vergleich zu den jeweiligen Grundiesen Farbunterschiede aufweisen.
As decorações Mosaic and Brick são sobre rede. Todas as decorações podem sofrer variações de tonalidade em relação aos respectivos mosaicos base.







grey EV4 90x90 TC

**FULL BODY
PORCELAIN**

evoke
collection

- ↓
DOWNLOAD
CATALOGUE
OUTDOOR
EXTRA THICK
- ↓
DOWNLOAD
BIM
- ↓
DOWNLOAD
CATALOGUE
- ↓
DOWNLOAD
TECHNICAL
FEATURES
- 🌐
VIEW
ONLINE

			
60x120	90x90	60x60	30x60
NR 9,5mm	NR 9,5mm	NR 8,5mm	NR 8,5mm
TC 9,5mm	TC 9,5mm	TC 8,5mm	
E ASR 20mm	E ASR 20mm	ASR 8,5mm	

rectified products . produits rectifiés . rektifizierte produkte . produtos retificados



white EV1 beige EV2 light grey EV3 grey EV4

UGL **V3** **R11** **R10**  **BIM**

ASR NR

E ASR



pour plus d'informations, consultez
<https://evaluation.cstb.fr>

MARGRES
CERAMIC TILES

index

colour map

collections

- bare&bold
- concept
- deck plus
- endless
- evoke**
- evolution
- fragment
- grove
- hybrid
- metropolis
- prestige
- pure stone
- slabstone
- stage
- subway
- tecnica
- thunder
- time 2.0
- tool

linea collections

useful information

collections

- bare&bold
- concept
- deck plus
- endless
- evoke**
- evolution
- fragment
- grove
- hybrid
- metropolis
- prestige
- pure stone
- slabstone
- stage
- subway
- tecnica
- thunder
- time 2.0
- tool

linea collections

useful information

evoke

— collection



172

general catalogue . 2026

beige EV2 60x60 ASR

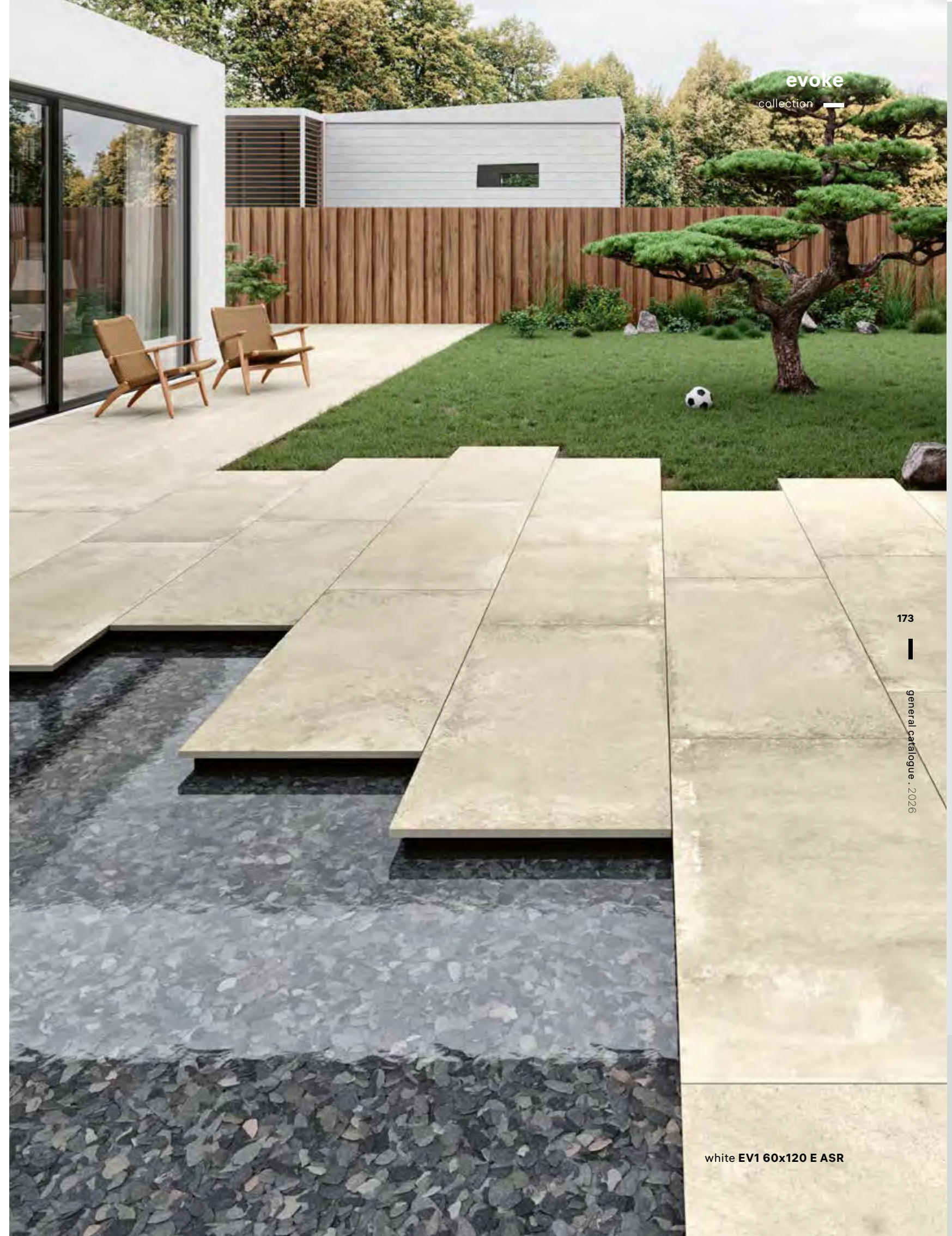

evoke

— collection

173

general catalogue . 2026

white EV1 60x120 E ASR

index



colour map



collections



bare&bold

concept

deck plus

endless

evoke

evolution

fragment

grove

hybrid

metropolis

prestige

pure stone

slabstone

stage

subway

tecnica

thunder

time 2.0

tool

linea collections



useful information



evoke

— collection

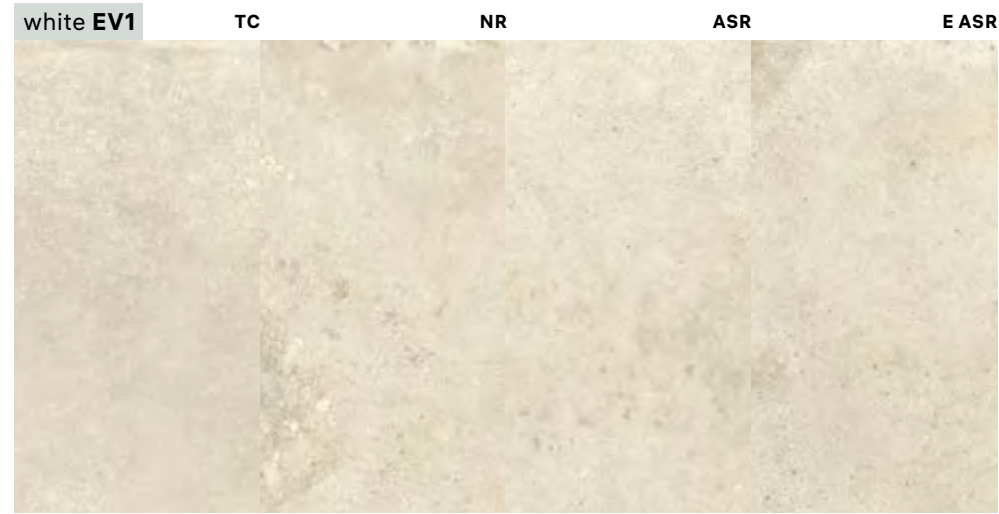

30x60	8,5mm	NR	R10	B	MG-2095
60x60	8,5mm	NR	R10	B	MG-2765
	8,5mm	TC	-	-	MG-2765
	8,5mm	ASR	R11	C	MG-2765
90x90	9,5mm	NR	R10	B	MG-3960
	9,5mm	TC	-	-	MG-3960
	20mm	E ASR	R11	C	MG-7690
60x120	9,5mm	NR	R10	B	MG-4695
	9,5mm	TC	-	-	MG-4695
	20mm	E ASR	R11	C	MG-7490



30x60	8,5mm	NR	R10	B	MG-2095
60x60	8,5mm	NR	R10	B	MG-2765
	8,5mm	TC	-	-	MG-2765
	8,5mm	ASR	R11	C	MG-2765
90x90	9,5mm	NR	R10	B	MG-3960
	9,5mm	TC	-	-	MG-3960
60x120	9,5mm	NR	R10	B	MG-4695
	9,5mm	TC	-	-	MG-4695

evoke

collection —

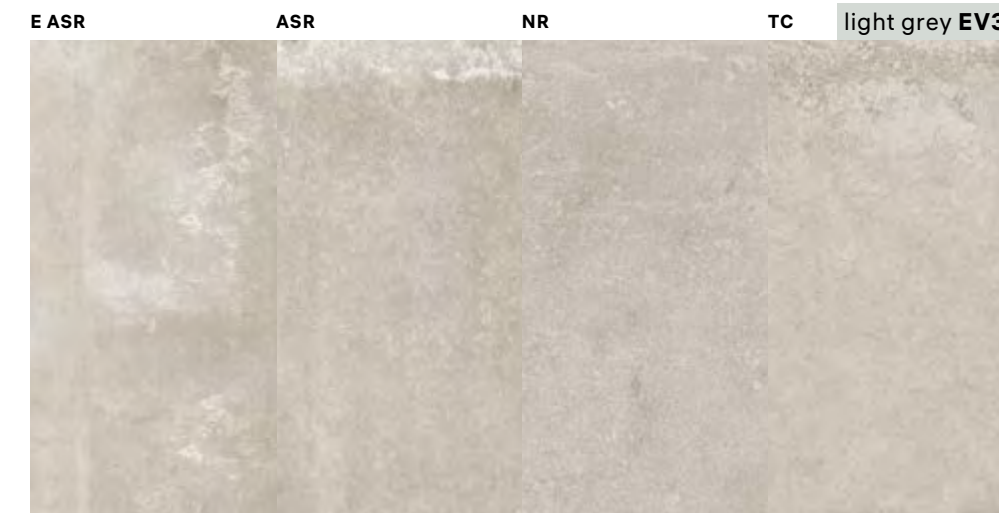

30x60	8,5mm	NR	R10	B	MG-2095
60x60	8,5mm	NR	R10	B	MG-2765
	8,5mm	TC	-	-	MG-2765
	8,5mm	ASR	R11	C	MG-2765
90x90	9,5mm	NR	R10	B	MG-3960
	9,5mm	TC	-	-	MG-3960
	20mm	E ASR	R11	C	MG-7690
60x120	9,5mm	NR	R10	B	MG-4695
	9,5mm	TC	-	-	MG-4695
	20mm	E ASR	R11	C	MG-7490

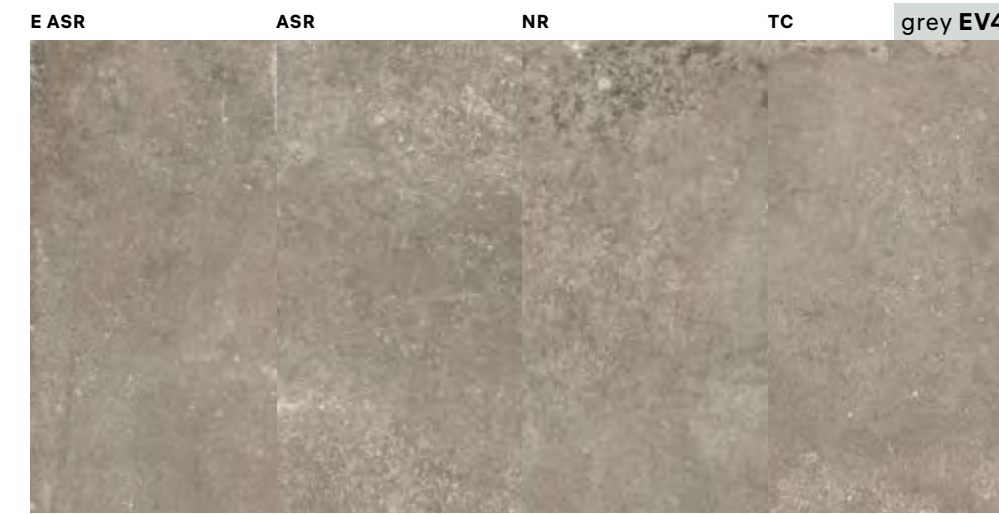

30x60	8,5mm	NR	R10	B	MG-2095
60x60	8,5mm	NR	R10	B	MG-2765
	8,5mm	TC	-	-	MG-2765
	8,5mm	ASR	R11	C	MG-2765
90x90	9,5mm	NR	R10	B	MG-3960
	9,5mm	TC	-	-	MG-3960
	20mm	E ASR	R11	C	MG-7690
60x120	9,5mm	NR	R10	B	MG-4695
	9,5mm	TC	-	-	MG-4695
	20mm	E ASR	R11	C	MG-7490

index

colour map

collections

- bare&bold
- concept
- deck plus
- endless
- evoke**
- evolution
- fragment
- grove
- hybrid
- metropolis
- prestige
- pure stone
- slabstone
- stage
- subway
- tecnica
- thunder
- time 2.0
- tool

linea collections

useful information

evoke

collection

evoke

collection

decors

décorations . dekorationen . decorações

8,5MM



mosaic evoke 5x5 white
30x30
NR MG-9640

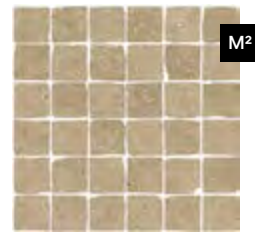

mosaic evoke 5x5 beige
30x30
NR MG-9640



mosaic evoke 5x5 light grey
30x30
NR MG-9640

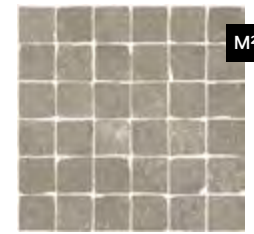

mosaic evoke 5x5 grey
30x30
NR MG-9640

8,5MM



bricks evoke white
30x30
TC MG-9640



bricks evoke beige
30x30
TC MG-9640



bricks evoke light grey
30x30
TC MG-9640



bricks evoke grey
30x30
TC MG-9640

special pieces

pièces spéciales . spezialteile . peças especiais

9,5 - 8,5MM

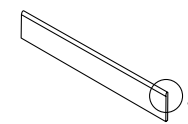
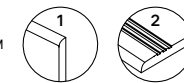

skirting
plinthe
sockel
rodapé

8x60
NR . TC MP-6170
8x90
NR . TC MP-6260
8x120
NR . TC MP-6260

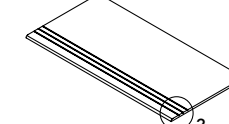

step tread grooved
nez de marche creusé
stufenplatte mit rillen
degrau sulcado

30x60
NR . TC . ASR MP-6240
30x90
NR . TC MP-6430
30x120
NR . TC MP-6445

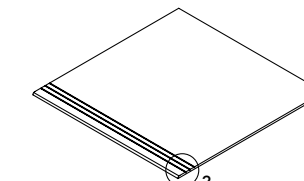

step tread grooved
nez de marche creusé
stufenplatte mit rillen
degrau sulcado

60x60
NR . TC . ASR MP-6400



9,5 - 8,5MM

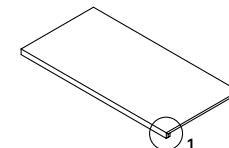
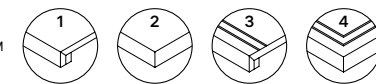

step tread "L"
nez de marche "L"
stufenplatte "L"
degrau "L"

30x60
NR . TC MP-6560
30x120
NR . TC MP-6595

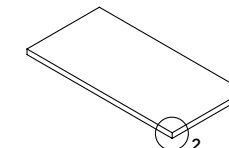

* step tread "L" corner
nez de marche "L" angle
ecke stufenplatte "L"
degrau "L" canto

30x60
NR . TC MP-6630
30x120
NR . TC MP-6655

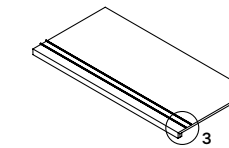

step tread "L" inox
nez de marche "L" inox
stufenplatte "L" inox
degrau "L" inox

30x60
NR . TC MP-6580
30x120
NR . TC MP-6670

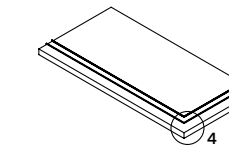

* step tread "L" corner inox
nez de marche "L" angle inox
ecke stufenplatte "L" inox
degrau "L" canto inox

30x60
NR . TC MP-6650
30x120
NR . TC MP-6710

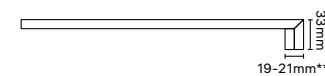

step tread "L" corner . nez de marche "L" angle
ecke stufenplatte "L" . degrau "L" canto

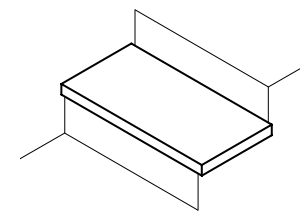

right corner . angle droit
rechten ecke . canto direito

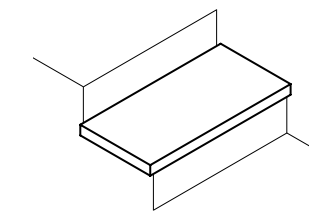

left corner . angle gauche
links ecke . canto esquerdo

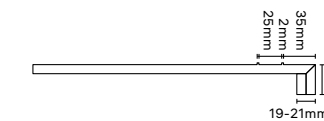

step tread "L" corner inox . nez de marche "L" angle inox
ecke stufenplatte "L" inox . degrau "L" canto inox

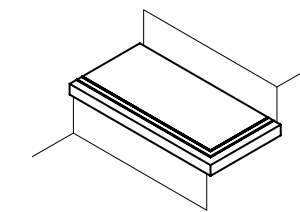

right corner . angle droit
rechten ecke . canto direito

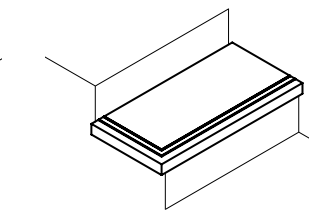

left corner . angle gauche
links ecke . canto esquerdo

OUTDOOR

EXTRA THICK
Special 20MM pieces please refer to page 348.
Pièces spéciales 20MM, veuillez consulter la page 348.
Speziellanfertigungen 20MM siehe Seite 348.
Peças especiais 20MM, por favor consulte a página 348.

Available in all colours
Disponible dans toutes les couleurs
Erhältlich in allen Farben
Disponível em todas as cores

* Available in right and left corner
Disponible dans les coin droit et gauche
Erhältlich in der rechten Ecke und links
Disponível no canto direito e esquerdo

** Dimension will vary depending on the base tile thickness.
La dimension varie selon l'épaisseur du carreau.
Das Maß variiert je nach Dicke der Fliese.
A dimensão varia consoante a espessura do material cerâmico.

Mosaic and Brick decors are net mounted. All decors may feature shade variations regarding the corresponding floor/wall tile standard tile.
Les décorations Mosaic et Brick sont sur trame. Toutes les décorations peuvent souffrir variations de tonalité par rapport aux carreaux base.
Die Mosaic und Brick Dekoration liegen auf einem Netz. Alle Dekorationen können im Vergleich zu den jeweiligen Grundiesen Farbunterschiede aufweisen.
As decorações Mosaic and Brick são sobre rede. Todas as decorações podem sofrer variações de tonalidade em relação aos respectivos mosaicos base.

MARGRES
CERAMIC TILES

index

colour map

collections

bare&bold

concept

deck plus

endless

evoke

evolution

fragment

grove

hybrid

metropolis

prestige

pure stone

slabstone

stage

subway

tecnica

thunder

time 2.0

tool

linea collections

useful information



calacatta PT1 60x120 NR . 60x60 P

LAMINATED
PORCELAIN
STONEWARE

DIGITEK
PORCELAIN
STONEWARE

prestige
collection



100x300
NR . P 5,5mm



100x250
NR . P 5,5mm

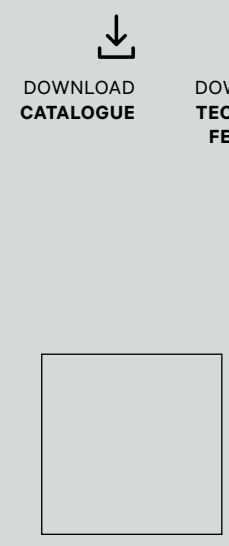

100x100
NR . P . ASR 5,5mm

↓
DOWNLOAD
CATALOGUE

↓
DOWNLOAD
TECHNICAL
FEATURES

🌐
VIEW
ONLINE

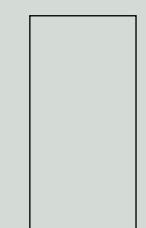

60x120
NR . P 9,5mm

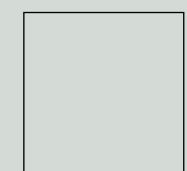

90x90
NR 9,5mm

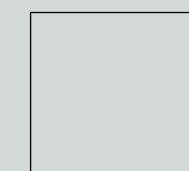

89x89
P 9,5mm



60x60
NR . P 8,5mm

rectified products . produits rectifiés . rektifizierte produkte . produtos retificados

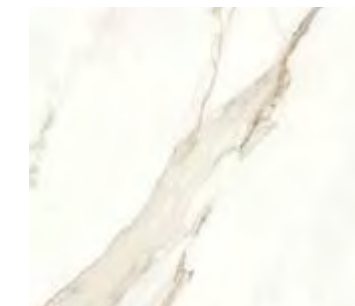

calacatta
PT1 . LPT1

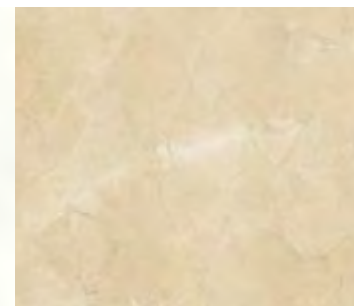

corinthian beige
PT2

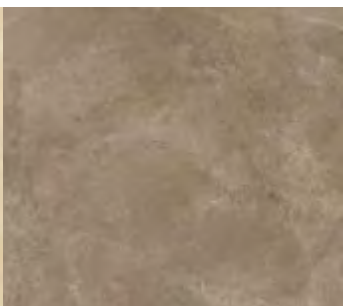

fior di bosco tortora
PT4

UGL **V2** **R10**
ASR NR ASR P

PR()TECT
Antibacterial for Life.

MARGRES
CERAMIC TILES

index

colour map

collections

- bare&bold
- concept
- deck plus
- endless
- evoke
- evolution
- fragment
- grove
- hybrid
- metropolis
- prestige**
- pure stone
- slabstone
- stage
- subway
- tecnica
- thunder
- time 2.0
- tool

linea collections

useful information

prestige
collection

prestige
collection

index

colour map

collections

bare&bold

concept

deck plus

endless

evoke

evolution

fragment

grove

hybrid

metropolis

prestige

pure stone

slabstone

stage

subway

tecnica

thunder

time 2.0

tool

linea collections

useful information

180

general catalogue . 2026

181

general catalogue . 2026

corinthian beige PT2 89x89 P

prestige

— collection



MARGRES
CERAMIC TILES



prestige

collection —

fior di bosco tortora PT4 90x90 NR

index

colour map

collections

bare&bold

concept

deck plus

endless

evoke

evolution

fragment

grove

hybrid

metropolis

prestige

pure stone

slabstone

stage

subway

tecnica

thunder

time 2.0

tool

linea collections

useful information

prestige

— collection



calacatta PT1 60x60 P

60x60	8,5mm	NR	-	-	MG-2775
	8,5mm	P	-	-	MG-3280
89x89	9,5mm	P	-	-	MG-4470
90x90	9,5mm	NR	-	-	MG-3955
60x120	9,5mm	NR	-	-	MG-4680
	9,5mm	P	-	-	MG-5160

LINEA

100x100	5,5mm	ASR	R10	-	M3-2730
	5,5mm	NR	-	-	M3-2730
	5,5mm	P	-	-	M3-3130
100x250	5,5mm	NR	-	-	M3-3530
	5,5mm	P	-	-	M3-3830
100x300	5,5mm	NR	-	-	M3-4230
	5,5mm	P	-	-	M3-4630

60x60	8,5mm	NR	-	-	MG-2775
	8,5mm	P	-	-	MG-3280
89x89	9,5mm	P	-	-	MG-4470
90x90	9,5mm	NR	-	-	MG-3955
60x120	9,5mm	NR	-	-	MG-4680
	9,5mm	P	-	-	MG-5160

60x60	8,5mm	NR	-	-	MG-2775
	8,5mm	P	-	-	MG-3280
89x89	9,5mm	P	-	-	MG-4470
90x90	9,5mm	NR	-	-	MG-3955
60x120	9,5mm	NR	-	-	MG-4680
	9,5mm	P	-	-	MG-5160

prestige

collection —

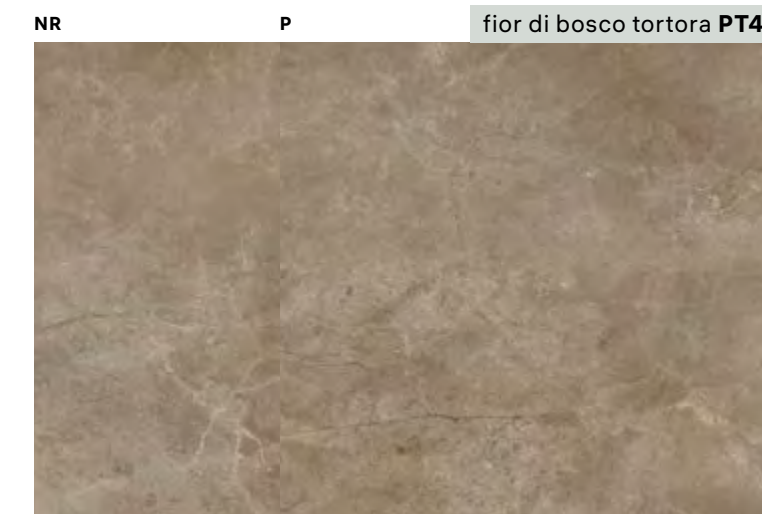
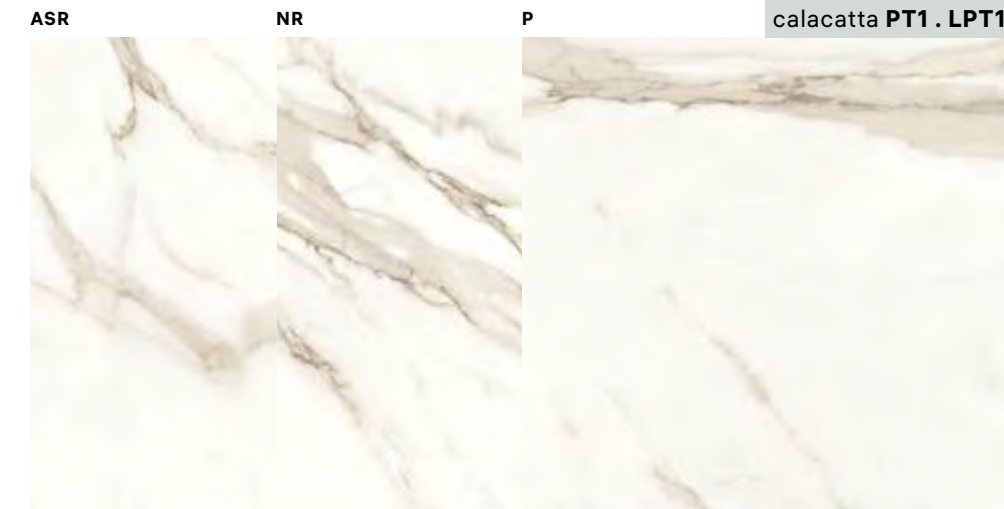

index

colour map

collections

- bare&bold
- concept
- deck plus
- endless
- evoke
- evolution
- fragment
- grove
- hybrid
- metropolis
- prestige**
- pure stone
- slabstone
- stage
- subway
- tecnica
- thunder
- time 2.0
- tool

linea collections

useful information

Products with a polished finish are more sensitive to abrasion and stains, what requires special conditions. Please see page 358 in chapter 09.
 Les produits à finition polie sont plus sensibles à l'abrasion et aux taches, ce qui requiert des conditions particulières. Veuillez-vous consulter la page 358 du chapitre 09.
 Produkte mit einer polierten Oberfläche sind empfindlicher gegen Abrieb und Fleckenbildung, was besondere Bedingungen erfordert. Bitte beachten Sie Seite 358 in Kapitel 09.
 Os produtos com acabamento polido são mais sensíveis à abrasão e às manchas, o que requer condições especiais. Por favor consulte a página 358 no capítulo 09.

An exclusive line of extremely high performance antimicrobial floor and wall tiles, designed for healthy, safe and protected living spaces. Anti-slip finish doesn't have antibacterial protection.
 Une ligne exclusive de sols et revêtements antibactériens aux performances très élevées, pour un habitat sain, sûr et protégé. La finition antidérapante n'a pas de protection antibactérienne.
 Eine exklusive Linie an hochwertigen Fußböden und antibakteriellen Wandverkleidungen, für ein gesundes, sicheres und geschütztes Leben. Die rutschfeste Oberfläche hat keinen antibakteriellen Schutz.
 Uma linha exclusiva de pavimentos e revestimentos antimicrobianos de altíssima performance, projetada para ambientes saudáveis, seguros e protegidos. O acabamento antiderrapante não tem proteção antibacteriana.

PROTECT
 Antibacterial for Life.

prestige

collection

prestige

collection

decors

décorations . dekorationen . decorações

8,5MM



mosaic prestige 4,4x5
(all colours)
30x30

NR MG-9580
P MG-9830

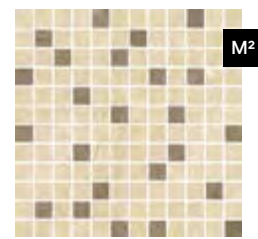

mosaic 2,3x2,3
summer spot
30x30

NR MG-9640
P MG-9885



bricks prestige
(all colours)
29,6x59,5

NR MP-6310
P MP-6330

8,5MM



mosaic shell
fior di bosco tortora
31x33

NR MP-6370
P MP-6380

8,5MM



mosaic sharp* (all colours)
22x28,5

NR MP-6330
P MP-6350

Mosaic and Brick decors are net mounted. All decors may feature shade variations regarding the corresponding floor/wall tile standard tile.
Les décorations Mosaic et Brick sont sur trame. Toutes les décorations peuvent souffrir variations de tonalité par rapport aux carreaux base.
Die Mosaic und Brick Dekoration liegen auf einem Netz. Alle Dekorationen können im Vergleich zu den jeweiligen Grundiesen Farbunterschiede aufweisen.
As decorações Mosaic and Brick são sobre rede. Todas as decorações podem sofrer variações de tonalidade em relação aos respectivos mosaicos base.

* Decoration available in 4 different patterns, sold randomly. Decorative pieces with precious metals are sensitive to acid attacks and must not be used for floors. Please see page 357.
Décoration avec 4 pièces différentes et vendues de façon aléatoire. Les pièces décoratives en métaux précieux sont sensibles aux attaques d'acides et ne doivent pas être appliqués sur les carrelages.
Veillez s'il vous plaît consulter la page 357.
Dekoration in 4 verschiedenen Mustern erhältlich, nach dem Zufallsprinzip verkauft. Dekorative Teile mit Edelmetallen sind gegen Säure empfindlich und sollten nicht als Bodenbelag zum Einsatz kommen. Bitte sehen Sie Seite 357.
Decoração com 4 peças diferentes e vendidas aleatoriamente. Peças decorativas com metais preciosos são sensíveis aos ataques ácidos e não devem ser aplicadas em pavimento. Por favor, ver a página 357.

special pieces

pièces spéciales . spezialteile . peças especiais

9,5 . 8,5MM

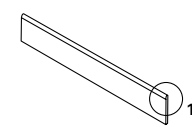
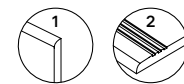

skirting
plinthe
sockel
rodapé

8x60
NR MP-6170
P MP-6180

8x89
P MP-6270

8x90
NR MP-6260

8x120
NR MP-6260
P MP-6270

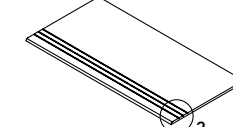

step tread grooved
nez de marche creusé
stufenplatte mit rillen
degrau sulcado

30x60
NR MP-6240
P MP-6270

30x89
P MP-6445

30x90
NR MP-6430

30x120
NR MP-6445
P MP-6470

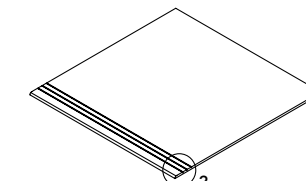

step tread grooved
nez de marche creusé
stufenplatte mit rillen
degrau sulcado

60x60
NR MP-6400
P MP-6430



9,5 . 8,5MM

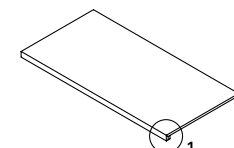
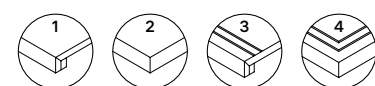

step tread "L"
nez de marche "L"
stufenplatte "L"
degrau "L"

30x60
NR . P MP-6560

30x120
NR . P MP-6595

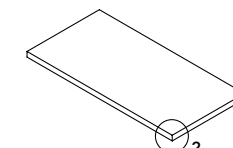

* step tread "L" corner
nez de marche "L" angle
ecke stufenplatte "L"
degrau "L" canto

30x60
NR . P MP-6630

30x120
NR . P MP-6655



step tread "L" corner . nez de marche "L" angle
ecke stufenplatte "L" . degrau "L" canto

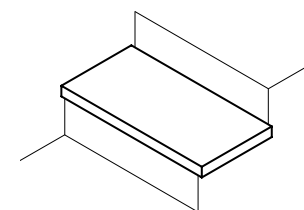

right corner . angle droit
rechten ecke . canto direito

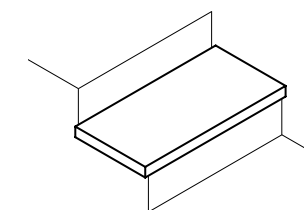

left corner . angle gauche
links ecke . canto esquerdo

Available in all colours
Disponible dans toutes les couleurs
Erhältlich in allen Farben
Disponível em todas as cores

* Available in right and left corner
Disponible dans les coin droit et gauche
Erhältlich in der rechten Ecke und links
Disponível no canto direito e esquerdo

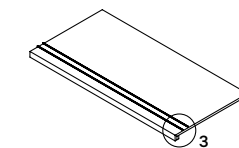

step tread "L" inox
nez de marche "L" inox
stufenplatte "L" inox
degrau "L" inox

30x60
NR . P MP-6580

30x120
NR . P MP-6670



step tread "L" corner inox . nez de marche "L" angle inox
ecke stufenplatte "L" inox . degrau "L" canto inox

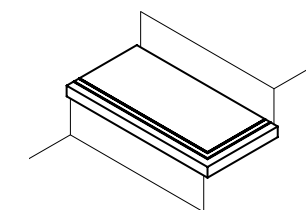

right corner . angle droit
rechten ecke . canto direito

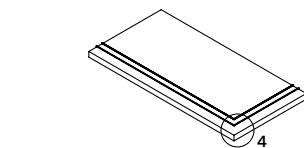

* step tread "L" corner inox
nez de marche "L" angle inox
ecke stufenplatte "L" inox
degrau "L" canto inox

30x60
NR . P MP-6650

30x120
NR . P MP-6710



left corner . angle gauche
links ecke . canto esquerdo

** Dimension will vary depending on the base tile thickness.
La dimension varie selon l'épaisseur du carreau.
Das Maß variiert je nach Dicke der Fliese.
A dimensão varia consoante a espessura do material cerâmico.

index

colour map

collections

bare&bold

concept

deck plus

endless

evoke

evolution

fragment

grove

hybrid

metropolis

prestige

pure stone

slabstone

stage

subway

tecnica

thunder

time 2.0

tool

linea collections

useful information



MOOD
eat, drink & share

188

general catalogue . 2026

light grey CT3 120x120 NR

FULL BODY
PORCELAIN

concept
collection

- ↓
DOWNLOAD
BIM
- ↓
DOWNLOAD
CATALOGUE
- ↓
DOWNLOAD
TECHNICAL
FEATURES
- 🌐
VIEW
ONLINE

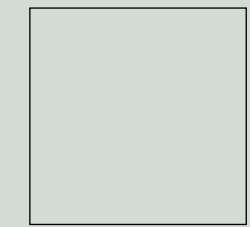

120x120
NR 9mm



60x120
NR 9,5mm
A 9,5mm

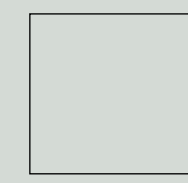

90x90
NR 9,5mm
A 9,5mm



45x90
NR 9mm
A 9mm
ASR 9mm

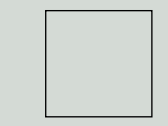

60x60
NR 8,5mm
A 8,5mm
ASR 8,5mm

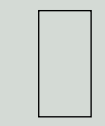

30x60
NR 8,5mm
A 8,5mm

rectified products . produits rectifiés . rektifizierte produkte . produtos retificados



white
CT1

beige
CT2

light grey
CT3

grey
CT4

UGL **V3** **R11** **R10**

ASR NR

BIM



pour plus d'informations, consultez
<https://evaluation.cstb.fr>

MARGRES
CERAMIC TILES

189

general catalogue . 2026

index

colour map

collections

bare&bold

concept

deck plus

endless

evoke

evolution

fragment

grove

hybrid

metropolis

prestige

pure stone

slabstone

stage

subway

tecnica

thunder

time 2.0

tool

linea collections

useful information

collections

bare&bold

concept

deck plus

endless

evoke

evolution

fragment

grove

hybrid

metropolis

prestige

pure stone

slabstone

stage

subway

tecnica

thunder

time 2.0

tool

linea collections

useful information

concept

— collection



192

general catalogue . 2026



concept

collection —



193

general catalogue . 2026

white CT1 60x60 A . 30x60 NR

index



colour map



collections



bare&bold

concept

deck plus

endless

evoke

evolution

fragment

grove

hybrid

metropolis

prestige

pure stone

slabstone

stage

subway

tecnica

thunder

time 2.0

tool

linea collections



useful information



concept

— collection



194

general catalogue . 2026

light grey CT3 45x90 NR . 45x90 ASR



195

general catalogue . 2026

grey CT4 60x60 A

index



colour map



collections



bare&bold

concept

deck plus

endless

evoke

evolution

fragment

grove

hybrid

metropolis

prestige

pure stone

slabstone

stage

subway

tecnica

thunder

time 2.0

tool

linea collections



useful information



concept

— collection



30x60	8,5mm	NR	R10	B	MG-2095
	8,5mm	A	-	-	MG-2370
60x60	8,5mm	NR	R10	B	MG-2765
	8,5mm	A	-	-	MG-3080
	8,5mm	ASR	R11	C	MG-2765
45x90	9mm	NR	R10	B	MG-3560
	9mm	A	-	-	MG-3730
	9mm	ASR	R11	C	MG-3560
90x90	9,5mm	NR	R10	B	MG-3960
	9,5mm	A	-	-	MG-4290
60x120	9,5mm	NR	R10	B	MG-4695
	9,5mm	A	-	-	MG-4970
120x120	9mm	NR	R10	B	MG-5450



30x60	8,5mm	NR	R10	B	MG-2095
	8,5mm	A	-	-	MG-2370
60x60	8,5mm	NR	R10	B	MG-2765
	8,5mm	A	-	-	MG-3080
	8,5mm	ASR	R11	C	MG-2765
45x90	9mm	NR	R10	B	MG-3560
	9mm	A	-	-	MG-3730
	9mm	ASR	R11	C	MG-3560
90x90	9,5mm	NR	R10	B	MG-3960
	9,5mm	A	-	-	MG-4290
60x120	9,5mm	NR	R10	B	MG-4695
	9,5mm	A	-	-	MG-4970

concept

collection —

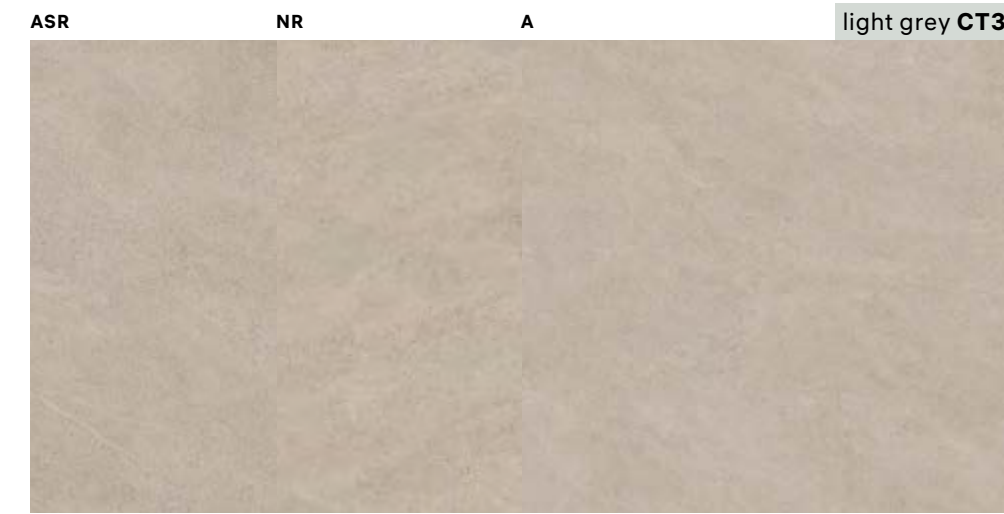

30x60	8,5mm	NR	R10	B	MG-2095
	8,5mm	A	-	-	MG-2370
60x60	8,5mm	NR	R10	B	MG-2765
	8,5mm	A	-	-	MG-3080
	8,5mm	ASR	R11	C	MG-2765
45x90	9mm	NR	R10	B	MG-3560
	9mm	A	-	-	MG-3730
	9mm	ASR	R11	C	MG-3560
90x90	9,5mm	NR	R10	B	MG-3960
	9,5mm	A	-	-	MG-4290
60x120	9,5mm	NR	R10	B	MG-4695
	9,5mm	A	-	-	MG-4970
120x120	9mm	NR	R10	B	MG-5450

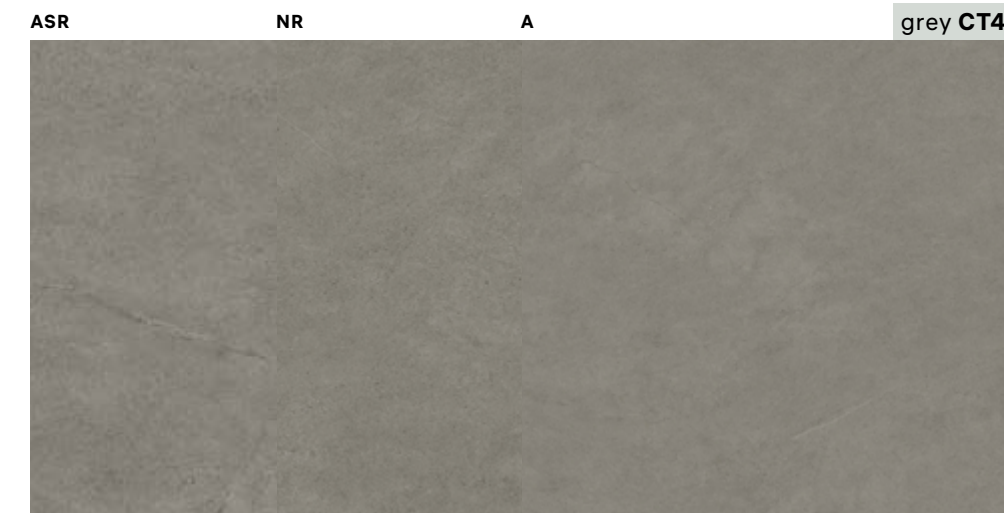

30x60	8,5mm	NR	R10	B	MG-2095
	8,5mm	A	-	-	MG-2370
60x60	8,5mm	NR	R10	B	MG-2765
	8,5mm	A	-	-	MG-3080
	8,5mm	ASR	R11	C	MG-2765
45x90	9mm	NR	R10	B	MG-3560
	9mm	A	-	-	MG-3730
	9mm	ASR	R11	C	MG-3560
90x90	9,5mm	NR	R10	B	MG-3960
	9,5mm	A	-	-	MG-4290
60x120	9,5mm	NR	R10	B	MG-4695
	9,5mm	A	-	-	MG-4970

index

colour map

collections

bare&bold

concept

deck plus

endless

evoke

evolution

fragment

grove

hybrid

metropolis

prestige

pure stone

slabstone

stage

subway

tecnica

thunder

time 2.0

tool

linea collections

useful information

concept

collection

decors

décorations . dekorationen . decorações

8,5MM

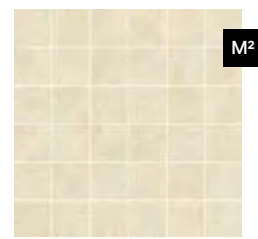

mosaic concept 5x5 white
30x30
NR MG-9570
A MG-9745



mosaic concept 5x5 beige
30x30
NR MG-9570
A MG-9745



mosaic concept 5x5 light grey
30x30
NR MG-9570
A MG-9745

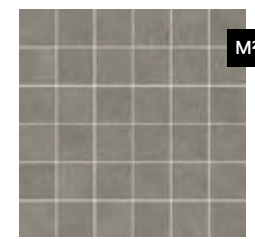

mosaic concept 5x5 grey
30x30
NR MG-9570
A MG-9745

8,5MM



mosaic concept
2,3x2,3 white mix
30x30
A MG-9790



mosaic concept
2,3x2,3 grey mix
30x30
A MG-9790

8,5MM



bricks concept white
15x60
NR MP-6320
A MP-6330



bricks concept beige
15x60
NR MP-6320
A MP-6330



bricks concept light grey
15x60
NR MP-6320
A MP-6330



bricks concept grey
15x60
NR MP-6320
A MP-6330

Mosaic and Brick decors are net mounted. All decors may feature shade variations regarding the corresponding floor/wall tile standard tile.
Les décorations Mosaic et Brick sont sur trame. Toutes les décorations peuvent souffrir variations de tonalité par rapport aux carreaux base.
Die Mosaic und Brick Dekoration liegen auf einem Netz. Alle Dekorationen können im Vergleich zu den jeweiligen Grundiesen Farbunterschiede aufweisen.
As decorações Mosaic and Brick são sobre rede. Todas as decorações podem sofrer variações de tonalidade em relação aos respectivos mosaicos base.

MARGRES
CERAMIC TILES

concept

collection

special pieces

pièces spéciales . spezialteile . peças especiais

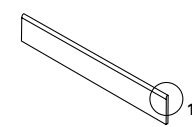

skirting
plinthe
sockel
rodapé

8x60
NR MP-6170
A MP-6180

8x90
NR MP-6260
A MP-6270

8x120
NR MP-6260
A MP-6270

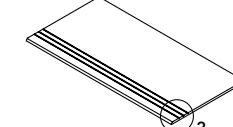

step tread grooved
nez de marche creusé
stufenplatte mit rillen
degrau sulcado

30x60
NR . ASR MP-6240
A MP-6270

30x90
NR . ASR MP-6430
A MP-6445

30x120
NR MP-6445
A MP-6470

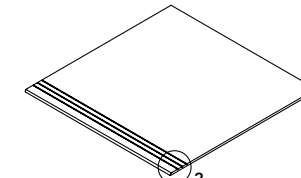

step tread grooved
nez de marche creusé
stufenplatte mit rillen
degrau sulcado

60x60
NR . ASR MP-6400
A MP-6430

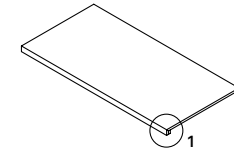
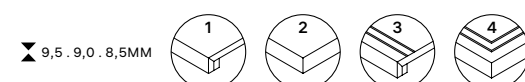

step tread "L"
nez de marche "L"
stufenplatte "L"
degrau "L"

30x60
NR . A MP-6560

30x120
NR . A MP-6595

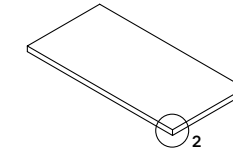

* step tread "L" corner
nez de marche "L" angle
ecke stufenplatte "L"
degrau "L" canto

30x60
NR . A MP-6630

30x120
NR . A MP-6655

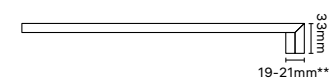

step tread "L" corner . nez de marche "L" angle
ecke stufenplatte "L" . degrau "L" canto

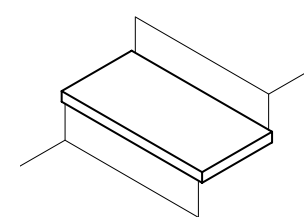

right corner . angle droit
rechten ecke . canto direito

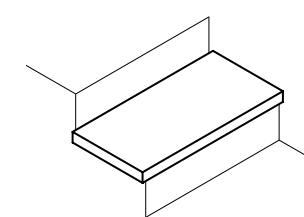

left corner . angle gauche
links ecke . canto esquerdo

Available in all colours
Disponible dans toutes les couleurs
Erhältlich in allen Farben
Disponível em todas as cores

* Available in right and left corner
Disponible dans les coin droit et gauche
Erhältlich in der rechten Ecke und links
Disponível no canto direito e esquerdo

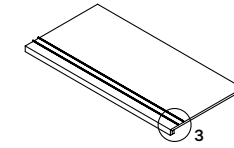

step tread "L" inox
nez de marche "L" inox
stufenplatte "L" inox
degrau "L" inox

30x60
NR . A MP-6580

30x120
NR . A MP-6670

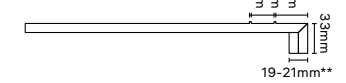

step tread "L" corner inox . nez de marche "L" angle inox
ecke stufenplatte "L" inox . degrau "L" canto inox

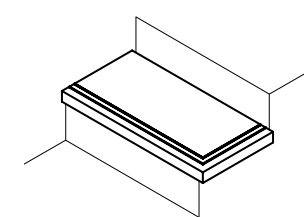

right corner . angle droit
rechten ecke . canto direito

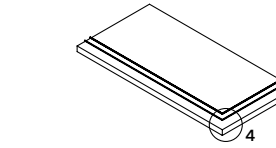

* step tread "L" corner inox
nez de marche "L" angle inox
ecke stufenplatte "L" inox
degrau "L" canto inox

30x60
NR . A MP-6650

30x120
NR . A MP-6710

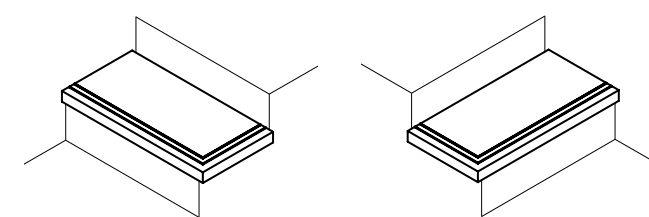

left corner . angle gauche
links ecke . canto esquerdo

** Dimension will vary depending on the base tile thickness.
La dimension varie selon l'épaisseur du carreau.
Das Maß variiert je nach Dicke der Fliese.
A dimensão varia consoante a espessura do material cerâmico.

index

colour map

collections

bare&bold

concept

deck plus

endless

evoke

evolution

fragment

grove

hybrid

metropolis

prestige

pure stone

slabstone

stage

subway

tecnica

thunder

time 2.0

tool

linea collections

useful information



DIGITEK
PORCELAIN
STONEWARE

grove
collection

- ↓
DOWNLOAD
CATALOGUE
OUTDOOR
EXTRA THICK
- ↓
DOWNLOAD
CATALOGUE
- ↓
DOWNLOAD
TECHNICAL
FEATURES
- VIEW
ONLINE

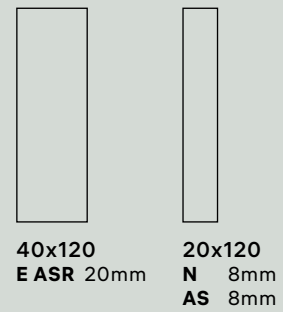

N . AS non-rectified products . produits non rectifiés . nicht rektifizierte produkte . produtos não retificados
E ASR rectified products . produits rectifiés . rektifizierte produkte . produtos retificados

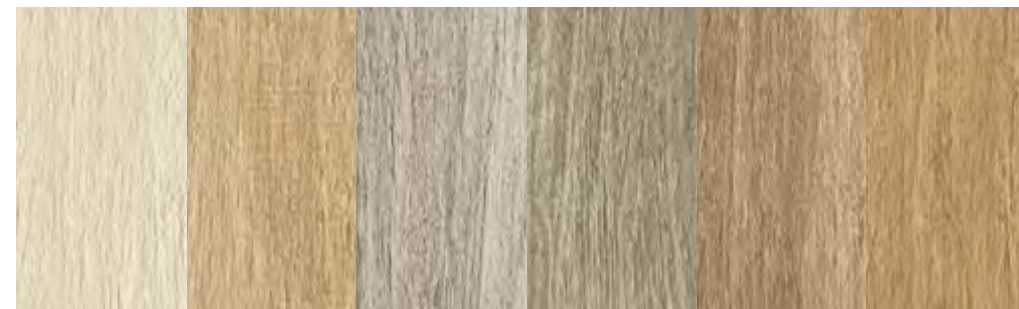

white GR1 beige GR2 grey GR3 tortora GR4 light brown GR5 brown GR6

UGL V2 R11 R10

AS N
E ASR

brown GR6 20x120 N . light brown GR5 20x120 AS

MARGRES
CERAMIC TILES

index

colour map

collections

- bare&bold
- concept
- deck plus
- endless
- evoke
- evolution
- fragment

grove

- hybrid
- metropolis
- prestige
- pure stone
- slabstone
- stage
- subway
- tecnica
- thunder
- time 2.0
- tool

linea collections

useful information

collections

- bare&bold
- concept
- deck plus
- endless
- evoke
- evolution
- fragment
- grove**
- hybrid
- metropolis
- prestige
- pure stone
- slabstone
- stage
- subway
- tecnica
- thunder
- time 2.0
- tool



collections

- bare&bold
- concept
- deck plus
- endless
- evoke
- evolution
- fragment
- grove**
- hybrid
- metropolis
- prestige
- pure stone
- slabstone
- stage
- subway
- tecnica
- thunder
- time 2.0
- tool

linea collections

useful information



204

general catalogue . 2026

22

205

general catalogue . 2026

grey GR3 20x120 N . 20x120 AS



206

207

general catalogue, 2026

general catalogue, 2026

light brown GR5 40x120 E ASR

index

colour map

collections

bare&bold

concept

deck plus

endless

evoke

evolution

fragment

grove

hybrid

metropolis

prestige

pure stone

slabstone

stage

subway

tecnica

thunder

time 2.0

tool

linea collections

useful information

grove

collection

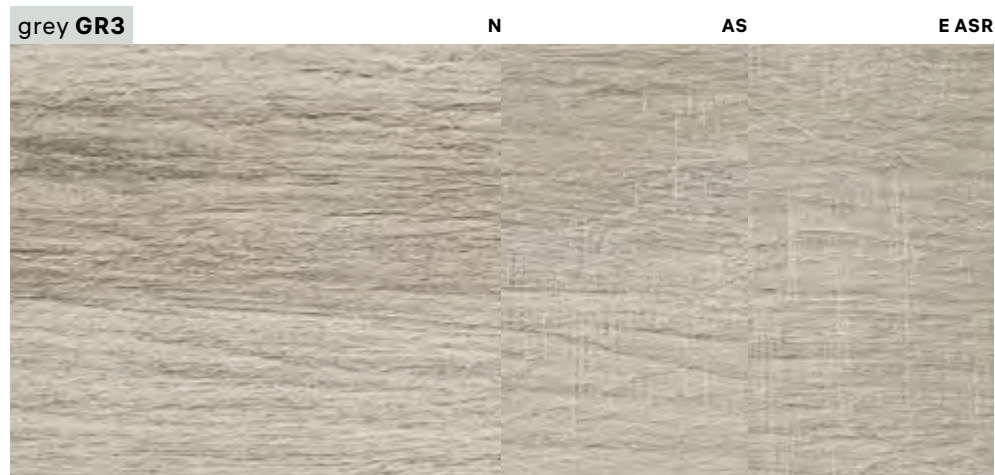

20x120 8mm N R10 B MG-1220

20x120 8mm N AS R10 B MG-1220
8mm AS R11 C MG-1245

20x120 8mm N AS R10 B MG-1220
8mm AS R11 C MG-1245
40x120 20mm E ASR R11 C MG-7290

grove

collection

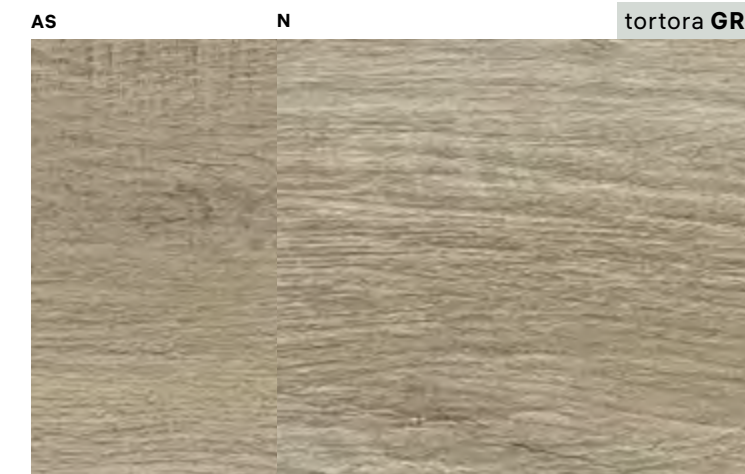

20x120 8mm N R10 B MG-1220
8mm AS R11 C MG-1245

20x120 8mm N AS R10 B MG-1220
8mm AS R11 C MG-1245
40x120 20mm E ASR R11 C MG-7290

20x120 8mm N R10 B MG-1220

208

209

general catalogue . 2026

general catalogue . 2026

laying suggestions

suggestions de pose . anwendungsvorschläge . sugestões de aplicação

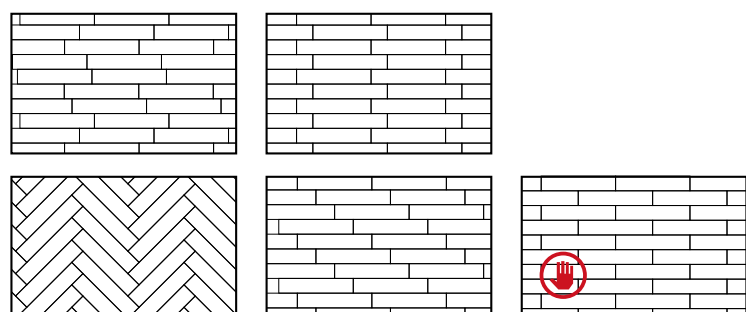

special pieces

pièces spéciales . spezialteile . peças especiais

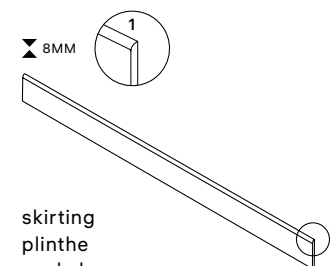

skirting
plinthe
sockel
rodapé
8x120 . 3,2"x 48"
N MP-6200

MARGRES
CERAMIC TILES

OUTDOOR

EXTRA THICK
Special 20MM pieces please refer to page 348.
Pièces spéciales 20MM, veuillez consulter la page 348.
Speziellanfertigungen 20MM siehe Seite 348.
Peças especiais 20MM, por favor consulte a página 348.

index

colour map

collections

- bare&bold
- concept
- deck plus
- endless
- evoke
- evolution
- fragment
- grove**
- hybrid
- metropolis
- prestige
- pure stone
- slabstone
- stage
- subway
- tecnica
- thunder
- time 2.0
- tool

linea collections

useful information



light grey TL2 45x90 A

LAMINATED
PORCELAIN
STONEWARE

FULL BODY
PORCELAIN

tool

collection —



120x260
NR 6mm

↓
DOWNLOAD
CATALOGUE
OUTDOOR
EXTRA THICK

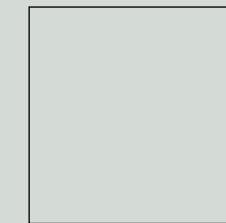

120x120
NR 6mm

↓
DOWNLOAD
CATALOGUE

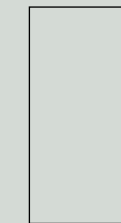

60x120
NR 6mm

↓
DOWNLOAD
TECHNICAL
FEATURES

VIEW
ONLINE



90x90
NR 9,5mm
A 9,5mm
ASR 9,5mm



45x90
NR 9mm
A 9mm



60x60
NR 8,5mm
TC 8,5mm
A 8,5mm
E ASR 20mm

rectified products . produits rectifiés . rektifizierete produkte . produtos retificados



white
TL1 . LTL1

light grey
TL2 . LTL2

tortora
TL3 . LTL3

grey
TL4 . LTL4

UGL **V3** **R11** **R10** **R9** **LINEA**
ASR NR



pour plus d'informations, consultez
<https://evaluation.cstb.fr>

PR()TECT

Antibacterial for Life.

MARGRES
CERAMIC TILES

index

colour map

collections

bare&bold

concept

deck plus

endless

evoke

evolution

fragment

grove

hybrid

metropolis

prestige

pure stone

slabstone

stage

subway

tecnica

thunder

time 2.0

tool

linea collections

useful information

tool

— collection



212

general catalogue . 2026

tool

collection —



213

general catalogue . 2026

white TL1 45x90 NR

index

colour map

collections

- bare&bold
- concept
- deck plus
- endless
- evoke
- evolution
- fragment
- grove
- hybrid
- metropolis
- prestige
- pure stone
- slabstone
- stage
- subway
- tecnica
- thunder
- time 2.0

tool

linea collections

useful information

tool

— collection



214

general catalogue . 2026

tortora TL3 90x90 NR

tool

collection —

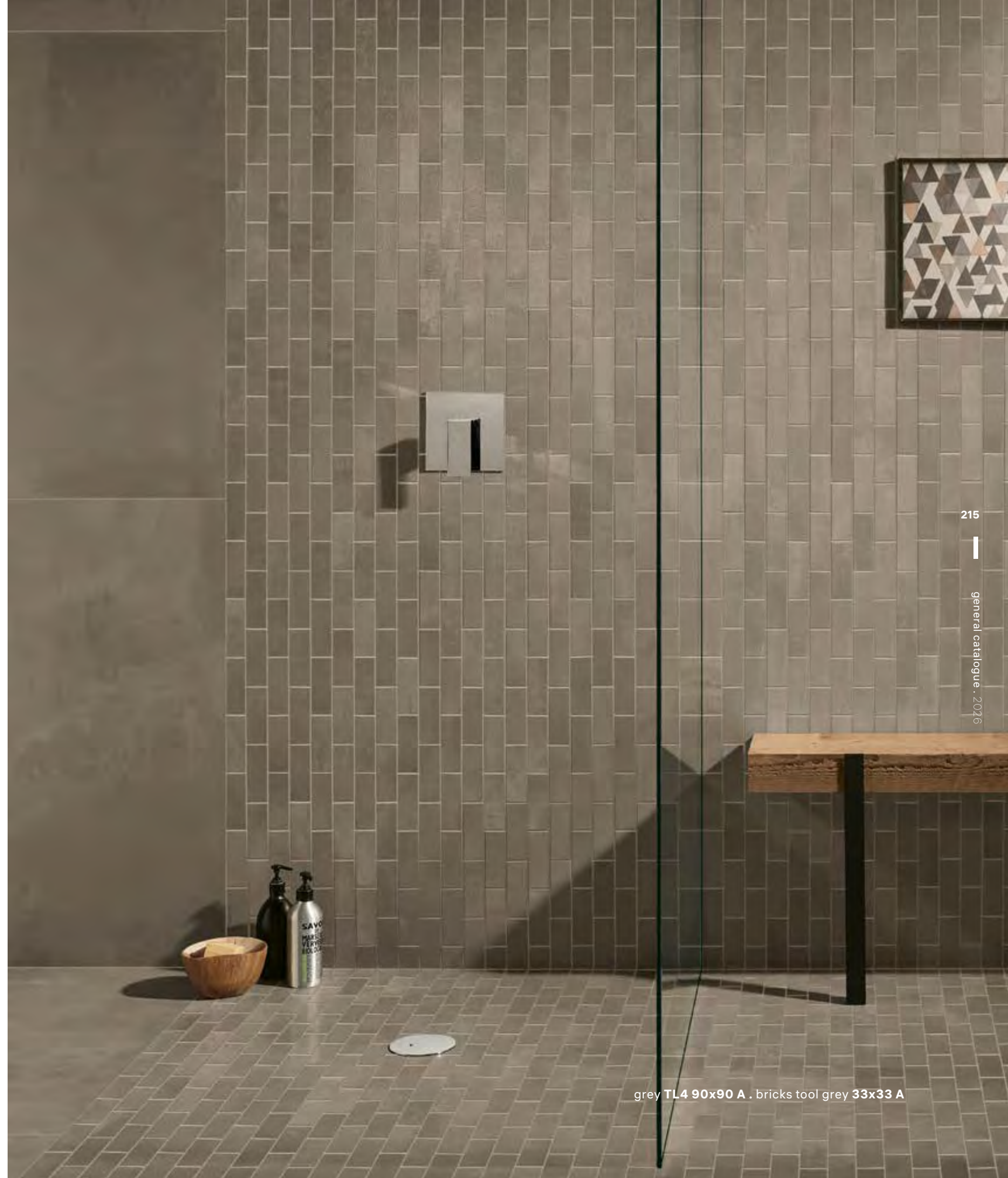

215

general catalogue . 2026

grey TL4 90x90 A . bricks tool grey 33x33 A

index



colour map



collections



bare&bold

concept

deck plus

endless

evoke

evolution

fragment

grove

hybrid

metropolis

prestige

pure stone

slabstone

stage

subway

tecnica

thunder

time 2.0

tool



linea collections



useful information



light grey TL2 90x90 ASR



grey TL4 60x60 E ASR

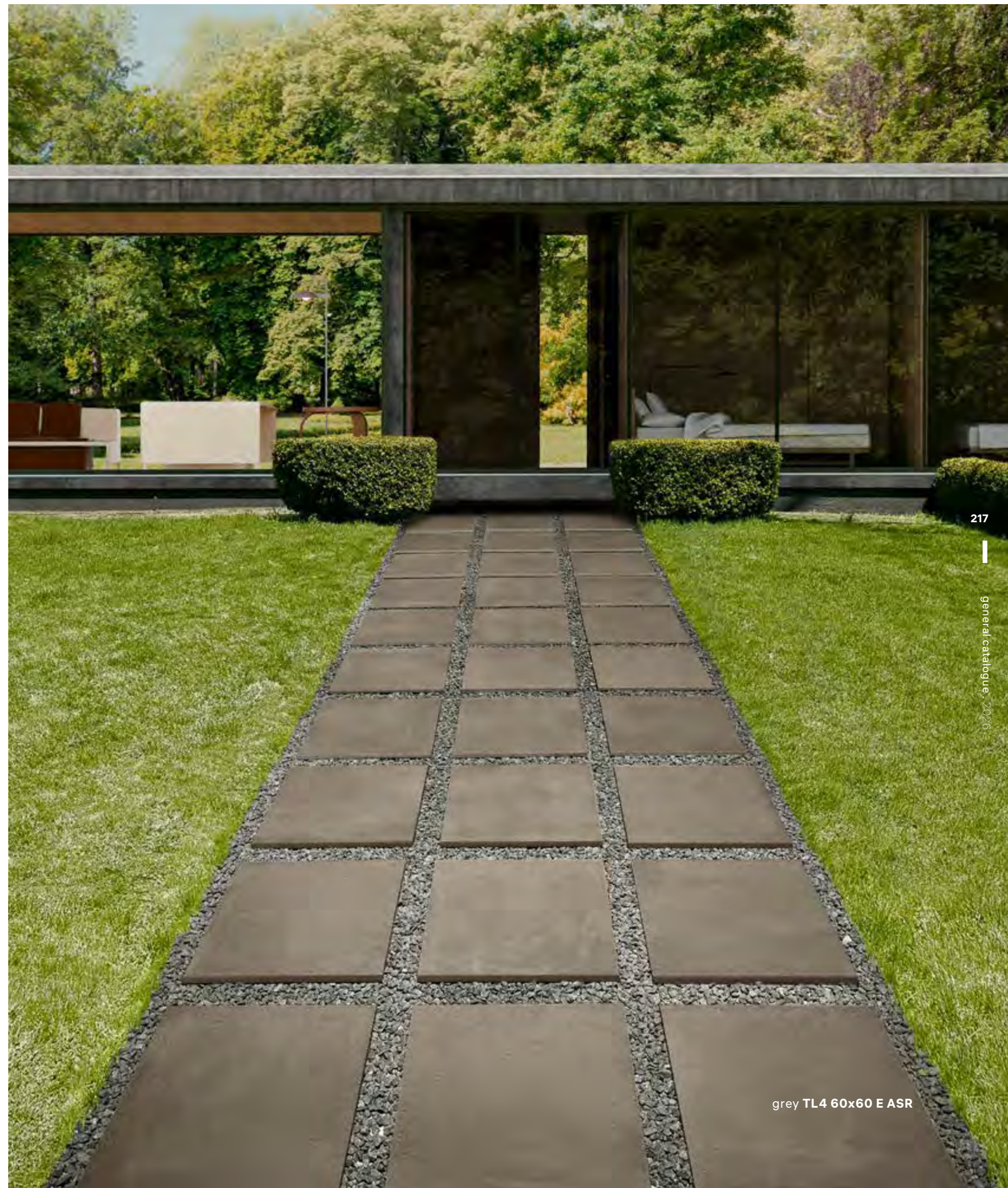

collections

- bare&bold
- concept
- deck plus
- endless
- evolve
- evolution
- fragment
- grove
- hybrid
- metropolis
- prestige
- pure stone
- slabstone
- stage
- subway
- tecnica
- thunder
- time 2.0

tool

tool

collection

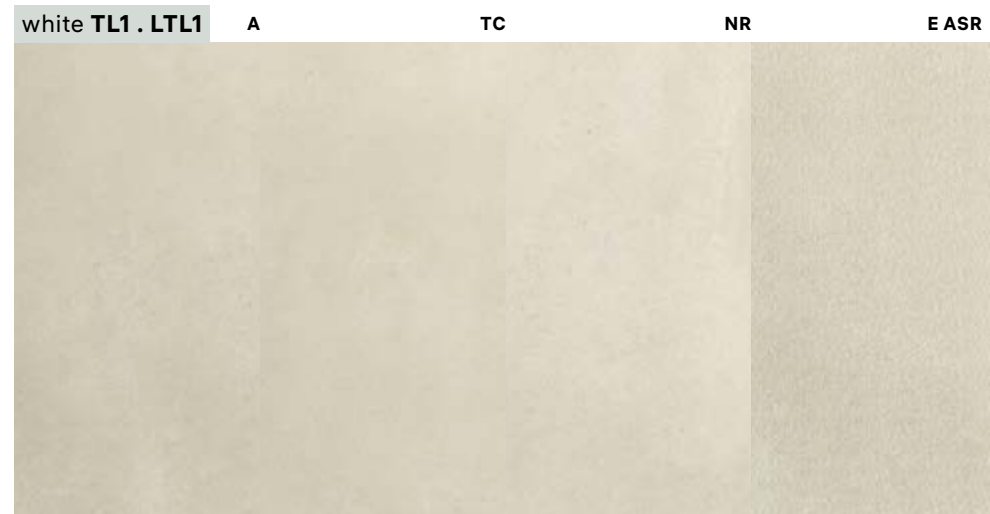

60x60	8,5mm	NR	R10	A	MG-2765
	8,5mm	TC	-	-	MG-2765
	8,5mm	A	-	-	MG-3080
	20mm	E ASR	R11	C	MG-7090
45x90	9mm	NR	R10	A	MG-3560
	9mm	A	-	-	MG-3730
90x90	9,5mm	NR	R10	A	MG-3960
	9,5mm	A	-	-	MG-4290
LINEA					
60x120	6mm	NR	R9	-	M3-5730
120x120	6mm	NR	R9	-	M3-6730
120x260	6mm	NR	R9	-	M3-8230

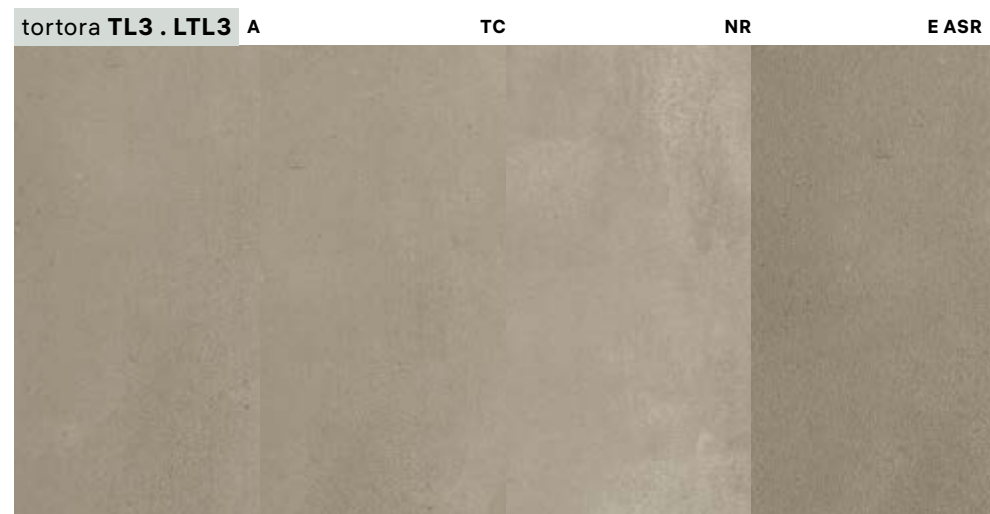

60x60	8,5mm	NR	R10	A	MG-2765
	8,5mm	TC	-	-	MG-2765
	8,5mm	A	-	-	MG-3080
	20mm	E ASR	R11	C	MG-7090
45x90	9mm	NR	R10	A	MG-3560
	9mm	A	-	-	MG-3730
90x90	9,5mm	NR	R10	A	MG-3960
	9,5mm	A	-	-	MG-4290
LINEA					
60x120	6mm	NR	R9	-	M3-5730
120x120	6mm	NR	R9	-	M3-6730
120x260	6mm	NR	R9	-	M3-8230

tool

collection

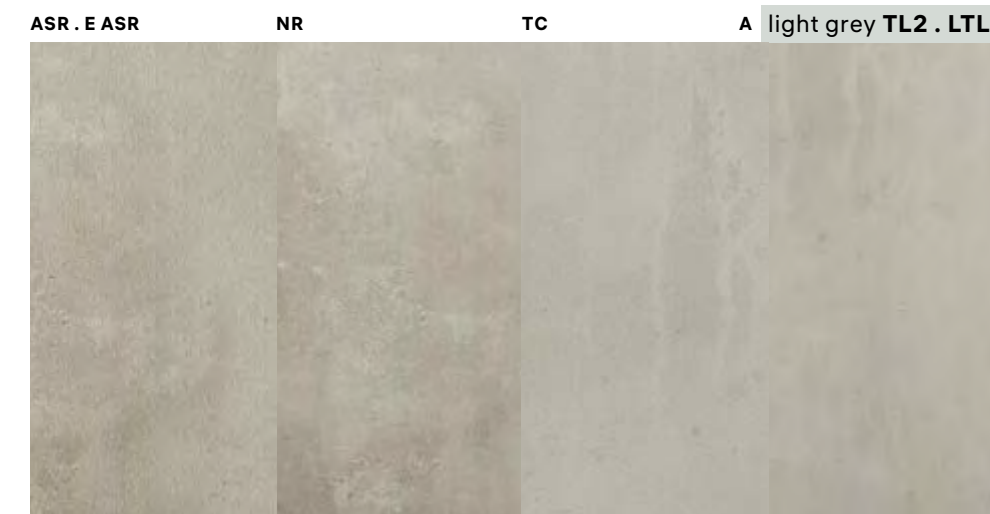

60x60	8,5mm	NR	R10	A	MG-2765
	8,5mm	TC	-	-	MG-2765
	8,5mm	A	-	-	MG-3080
	20mm	E ASR	R11	C	MG-7090
45x90	9mm	NR	R10	A	MG-3560
	9mm	A	-	-	MG-3730
90x90	9,5mm	NR	R10	A	MG-3960
	9,5mm	A	-	-	MG-4290
	9,5mm	ASR	R11	B	MG-3960
LINEA					
60x120	6mm	NR	R9	-	M3-5730
120x120	6mm	NR	R9	-	M3-6730
120x260	6mm	NR	R9	-	M3-8230



60x60	8,5mm	NR	R10	A	MG-2765
	8,5mm	TC	-	-	MG-2765
	8,5mm	A	-	-	MG-3080
	20mm	E ASR	R11	C	MG-7090
45x90	9mm	NR	R10	A	MG-3560
	9mm	A	-	-	MG-3730
90x90	9,5mm	NR	R10	A	MG-3960
	9,5mm	A	-	-	MG-4290
	9,5mm	ASR	R11	B	MG-3960
LINEA					
60x120	6mm	NR	R9	-	M3-5730
120x120	6mm	NR	R9	-	M3-6730
120x260	6mm	NR	R9	-	M3-8230

index

colour map

collections

bare&bold

concept

deck plus

endless

evoke

evolution

fragment

grove

hybrid

metropolis

prestige

pure stone

slabstone

stage

subway

tecnica

thunder

time 2.0

tool

linea collections

useful information

tool

collection

decors

décorations . dekorationen . decorações

8,5MM



mosaic tool 5x5 white
30x30
NR MG-9570



mosaic tool 5x5 light grey
30x30
NR MG-9570

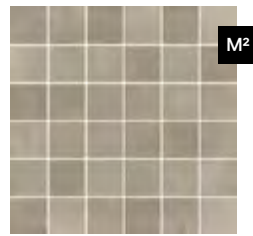

mosaic tool 5x5 tortora
30x30
NR MG-9570



mosaic tool 5x5 grey
30x30
NR MG-9570

8,5MM



bricks tool white
33x33
NR MG-9570
A MG-9745



bricks tool light grey
33x33
NR MG-9570
A MG-9745



bricks tool tortora
33x33
NR MG-9570
A MG-9745



bricks tool grey
33x33
NR MG-9570
A MG-9745

8,5MM



mosaic hexagon tool white
24x26,6
NR MG-9660



mosaic hexagon tool light grey
24x26,6
NR MG-9660



mosaic hexagon tool tortora
24x26,6
NR MG-9660

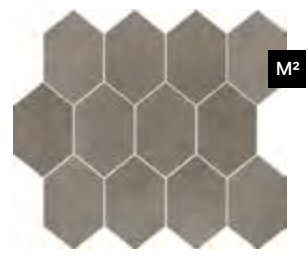

mosaic hexagon tool grey
24x26,6
NR MG-9660

8,5MM



barra tool
(all colours)
10x60
NR . A MP-6080

Mosaic and Brick decors are net mounted. All decors may feature shade variations regarding the corresponding floor/wall tile standard tile.
Les décorations Mosaic et Brick sont sur trame. Toutes les décorations peuvent souffrir variations de tonalité par rapport aux carreaux base.
Die Mosaic und Brick Dekoration liegen auf einem Netz. Alle Dekorationen können im Vergleich zu den jeweiligen Grundiesen Farbunterschiede aufweisen.
As decorações Mosaic and Brick são sobre rede. Todas as decorações podem sofrer variações de tonalidade em relação aos respectivos mosaicos base.

MARGRES
CERAMIC TILES

special pieces

pièces spéciales . spezialteile . peças especiais

9,5 . 8,5MM

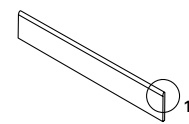
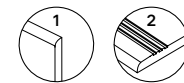

skirting
plinthe
sockel
rodapé

8x60
NR . TC MP-6170
A MP-6180
8x90
NR MP-6260
A MP-6270

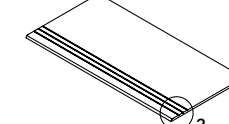

step tread grooved
nez de marche creusé
stufenplatte mit rillen
degrau sulcado

30x60
NR . TC MP-6240
A MP-6270
30x90
NR . ASR* MP-6430
A MP-6445

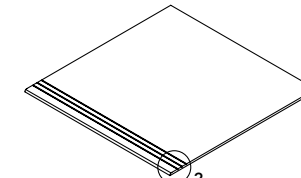

step tread grooved
nez de marche creusé
stufenplatte mit rillen
degrau sulcado

60x60
NR . TC MP-6400
A MP-6430



8,5MM

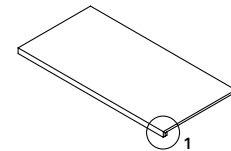
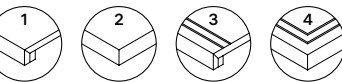

step tread "L"
nez de marche "L"
stufenplatte "L"
degrau "L"

30x60
NR . TC . A MP-6560

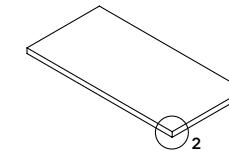

** step tread "L" corner
nez de marche "L" angle
ecke stufenplatte "L"
degrau "L" canto

30x60
NR . TC . A MP-6630

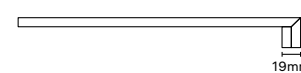

step tread "L" corner . nez de marche "L" angle
ecke stufenplatte "L" . degrau "L" canto

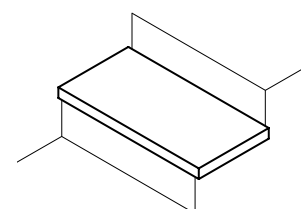

right corner . angle droit
rechten ecke . canto direito

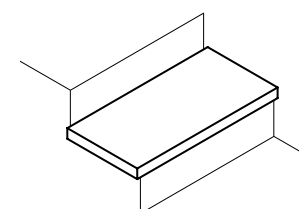

left corner . angle gauche
links ecke . canto esquerdo

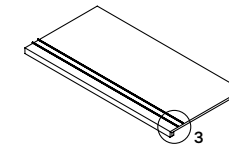

step tread "L" inox
nez de marche "L" inox
stufenplatte "L" inox
degrau "L" inox

30x60
NR . TC . A MP-6580



step tread "L" corner inox . nez de marche "L" angle inox
ecke stufenplatte "L" inox . degrau "L" canto inox

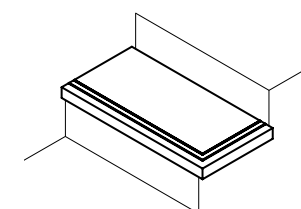

right corner . angle droit
rechten ecke . canto direito

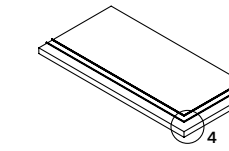

** step tread "L" corner inox
nez de marche "L" angle inox
ecke stufenplatte "L" inox
degrau "L" canto inox

30x60
NR . TC . A MP-6650



left corner . angle gauche
links ecke . canto esquerdo

OUTDOOR

EXTRA THICK

Special 20MM pieces please refer to page 348.
Pièces spéciales 20MM, veuillez consulter la page 348.
Speziellanfertigungen 20MM siehe Seite 348.
Peças especiais 20MM, por favor consulte a página 348.

Available in all colours
Disponible dans toutes les couleurs
Erhältlich in allen Farben
Disponível em todas as cores

* Available only in colours Light Grey and Grey
Disponible uniquement dans les couleurs Light Grey et Grey
Nur in den Farben Light Grey und Grey verfügbar
Disponível unicamente nas cores Light Grey e Grey

** Available in right and left corner
Disponible dans les coin droit et gauche
Erhältlich in der rechten Ecke und links
Disponível no canto direito e esquerdo

index

colour map

collections

bare&bold

concept

deck plus

endless

evoke

evolution

fragment

grove

hybrid

metropolis

prestige

pure stone

slabstone

stage

subway

tecnica

thunder

time 2.0

tool

linea collections

useful information



222

general catalogue . 2026

grey SL5 60x60 NR

LAMINATED
PORCELAIN
STONEWARE

FULL BODY
PORCELAIN

slabstone

collection



100x300
NR 3,5mm

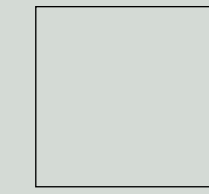

100x100
NR 3,5mm

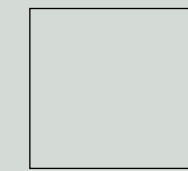

90x90
NR 9,5mm
ASR 9,5mm



45x90
NR 9mm

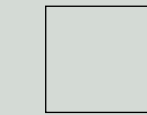

60x60
NR 8,5mm
A 8,5mm
ASR 8,5mm
E ASR 20mm

- DOWNLOAD BIM**
- DOWNLOAD CATALOGUE**
- DOWNLOAD TECHNICAL FEATURES**
- VIEW ONLINE**
- DOWNLOAD CATALOGUE OUTDOOR EXTRA THICK**

rectified products . produits rectifiés . rektifizierete produkte . produtos retificados



white SL1 . LSL1 beige SL2 . LSL2 tortora SL3 light grey SL4 grey SL5

UGL V2 R11 R10 R9
ASR E ASR NR LINEA LINEA



PR()TECT
Antibacterial for Life.

pour plus d'informations, consultez
<https://evaluation.cstb.fr>

MARGRES
CERAMIC TILES

223

general catalogue . 2026

index

colour map

collections

- bare&bold
- concept
- deck plus
- endless
- evoke
- evolution
- fragment
- grove
- hybrid
- metropolis
- prestige
- pure stone
- slabstone**
- stage
- subway
- tecnica
- thunder
- time 2.0
- tool

linea collections

useful information

slabstone

— collection



224

general catalogue . 2026



225

general catalogue . 2026

slabstone

collection —

index



colour map



collections



bare&bold

concept

deck plus

endless

evoke

evolution

fragment

grove

hybrid

metropolis

prestige

pure stone

slabstone

— stage

subway

tecnica

thunder

time 2.0

tool

linea collections



useful information



beige SL2 90x90 NR

slabstone

— collection



light grey SL4 45x90 NR . 90x90 NR

slabstone

collection —



beige SL2 60x60 E ASR

index



colour map



collections



bare&bold

concept

deck plus

endless

evoke

evolution

fragment

grove

hybrid

metropolis

prestige

pure stone

slabstone

stage

subway

tecnica

thunder

time 2.0

tool

227

general catalogue, 2026

linea collections



useful information



slabstone

collection

white SL1 . LSL1 A NR ASR . E ASR



60x60	8,5mm	NR	R10	B	MG-2780
	8,5mm	A	-	-	MG-3095
	8,5mm	ASR	R11	C	MG-2780
	20mm	E ASR	R11	C	MG-7090
45x90	9mm	NR	R10	B	MG-3580
90x90	9,5mm	NR	R10	B	MG-3970
	9,5mm	ASR	R11	C	MG-3970
LINEA					
100x100	3,5mm	NR	R9	-	M3-1230
100x300	3,5mm	NR	R9	-	M3-1530

beige SL2 . LSL2 A NR ASR . E ASR



60x60	8,5mm	NR	R10	B	MG-2780
	8,5mm	A	-	-	MG-3095
	8,5mm	ASR	R11	C	MG-2780
	20mm	E ASR	R11	C	MG-7090
45x90	9mm	NR	R10	B	MG-3580
90x90	9,5mm	NR	R10	B	MG-3970
	9,5mm	ASR	R11	C	MG-3970
LINEA					
100x100	3,5mm	NR	R9	-	M3-1230
100x300	3,5mm	NR	R9	-	M3-1530

tortora SL3 A NR ASR . E ASR



60x60	8,5mm	NR	R10	B	MG-2780
	8,5mm	A	-	-	MG-3095
	8,5mm	ASR	R11	C	MG-2780
	20mm	E ASR	R11	C	MG-7090
45x90	9mm	NR	R10	B	MG-3580
90x90	9,5mm	NR	R10	B	MG-3970
	9,5mm	ASR	R11	C	MG-3970

slabstone

collection

ASR . E ASR NR A light grey SL4



60x60	8,5mm	NR	R10	B	MG-2780
	8,5mm	A	-	-	MG-3095
	8,5mm	ASR	R11	C	MG-2780
	20mm	E ASR	R11	C	MG-7090
45x90	9mm	NR	R10	B	MG-3580
90x90	9,5mm	NR	R10	B	MG-3970
	9,5mm	ASR	R11	C	MG-3970

ASR . E ASR NR A grey SL5



60x60	8,5mm	NR	R10	B	MG-2780
	8,5mm	A	-	-	MG-3095
	8,5mm	ASR	R11	C	MG-2780
	20mm	E ASR	R11	C	MG-7090
45x90	9mm	NR	R10	B	MG-3580
90x90	9,5mm	NR	R10	B	MG-3970
	9,5mm	ASR	R11	C	MG-3970

index

colour map

collections

bare&bold

concept

deck plus

endless

evoke

evolution

fragment

grove

hybrid

metropolis

prestige

pure stone

slabstone

stage

subway

tecnica

thunder

time 2.0

tool

linea collections

useful information

228

general catalogue . 2026

229

general catalogue . 2026

MARGRES
CERAMIC TILES

PROTECT
Antibacterial for Life.

An exclusive line of extremely high performance antimicrobial floor and wall tiles, designed for healthy, safe and protected living spaces. Anti-slip finish doesn't have antibacterial protection.
Une ligne exclusive de sols et revêtements antibactériens aux performances très élevées, pour un habitat sain, sûr et protégé. La finition antidérapante n'a pas de protection antibactérienne.
Eine exklusive Linie an hochwertigen Fußböden und antibakteriellen Wandverkleidungen, für ein gesundes, sicheres und geschütztes Leben. Die rutschfeste Oberfläche hat keinen antibakteriellen Schutz.
Uma linha exclusiva de pavimentos e revestimentos antimicrobianos de altíssima performance, projetada para ambientes saudáveis, seguros e protegidos. O acabamento antiderrapante não tem proteção antibacteriana.

slabstone

collection

decors

décorations . dekorationen . decorações

8,5MM



mosaic slabstone
3,5x3,5 white
30x30
NR MG-9590

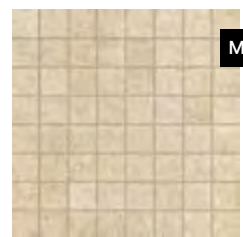

mosaic slabstone
3,5x3,5 beige
30x30
NR MG-9590



mosaic slabstone
3,5x3,5 tortora
30x30
NR MG-9590



mosaic slabstone
3,5x3,5 light grey
30x30
NR MG-9590

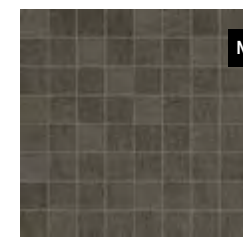

mosaic slabstone
3,5x3,5 grey
30x30
NR MG-9590

8,5MM



bricks slabstone white
29,6x49
NR MP-6320



bricks slabstone beige
29,6x49
NR MP-6320



bricks slabstone tortora
29,6x49
NR MP-6320



bricks slabstone light grey
29,6x49
NR MP-6320

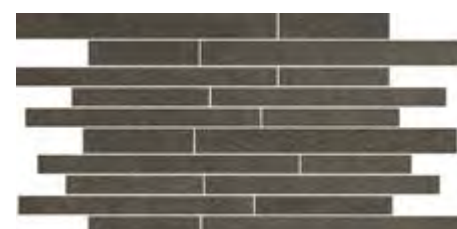

bricks slabstone grey
29,6x49
NR MP-6320

special pieces

pièces spéciales . spezialteile . peças especiais

9,5 . 8,5MM

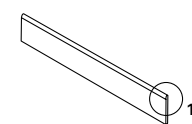
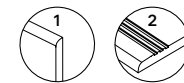

skirting
plinthe
sockel
rodapé
8x60
NR MP-6170
A MP-6180
8x90
NR MP-6260

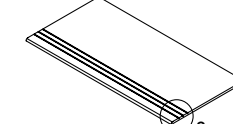

step tread grooved
nez de marche creusé
stufenplatte mit rillen
degrau sulcado
30x60
NR . ASR MP-6240
A MP-6270
30x90
NR . ASR MP-6430

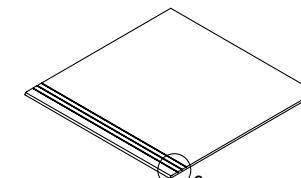

step tread grooved
nez de marche creusé
stufenplatte mit rillen
degrau sulcado
60x60
NR . ASR MP-6400
A MP-6430



8,5MM

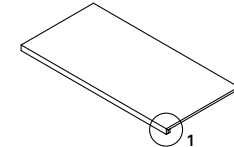
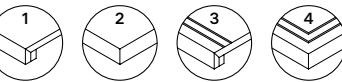

step tread "L"
nez de marche "L"
stufenplatte "L"
degrau "L"
30x60
NR . A MP-6560

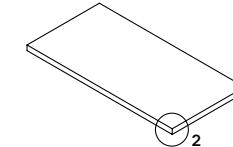

* step tread "L" corner
nez de marche "L" angle
ecke stufenplatte "L" inox
degrau "L" canto
30x60
NR . A MP-6630



step tread "L" corner . nez de marche "L" angle
ecke stufenplatte "L" . degrau "L" canto

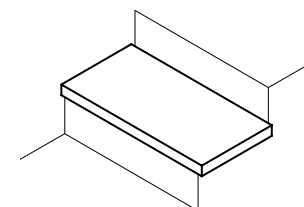

right corner . angle droit
rechten ecke . canto direito

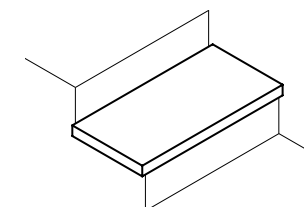

left corner . angle gauche
links ecke . canto esquerdo

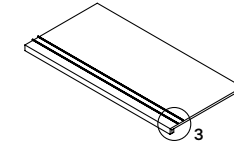

step tread "L" inox
nez de marche "L" inox
stufenplatte "L" inox
degrau "L" inox
30x60
NR . A MP-6580



step tread "L" corner inox . nez de marche "L" angle inox
ecke stufenplatte "L" inox . degrau "L" canto inox

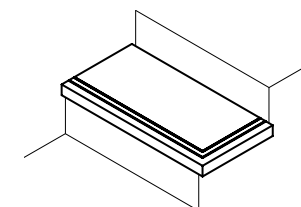

right corner . angle droit
rechten ecke . canto direito

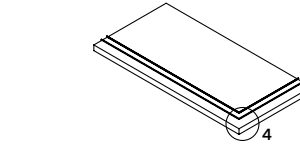

* step tread "L" corner inox
nez de marche "L" angle inox
ecke stufenplatte "L" inox
degrau "L" canto inox
30x60
NR . A MP-6650



left corner . angle gauche
links ecke . canto esquerdo

Mosaic and Bricks decors are net mounted. All decors may feature shade variations regarding the corresponding floor/wall tile standard tile.
Les décorations Mosaic et Bricks sont sur trame. Toutes les décorations peuvent souffrir variations de tonalité par rapport aux carreaux base.
Die Mosaic und Bricks Dekoration liegen auf einem Netz. Alle Dekorationen können im Vergleich zu den jeweiligen Grundiesen Farbunterschiede aufweisen.
As decorações Mosaic e Bricks são sobre rede. Todas as decorações podem sofrer variações de tonalidade em relação aos respectivos mosaicos base.

MARGRES
CERAMIC TILES

Available in all colours
Disponible dans toutes les couleurs
Erhältlich in allen Farben
Disponível em todas as cores

* Available in right and left corner
Disponible dans les coin droit et gauche
Erhältlich in der rechten Ecke und links
Disponível no canto direito e esquerdo

OUTDOOR

EXTRA THICK
Special 20MM pieces please refer to page 348.
Pièces spéciales 20MM, veuillez consulter la page 348.
Speziellanfertigungen 20MM siehe Seite 348.
Peças especiais 20MM, por favor consulte a página 348.

index

colour map

collections

bare&bold

concept

deck plus

endless

evoke

evolution

fragment

grove

hybrid

metropolis

prestige

pure stone

slabstone

stage

subway

tecnica

thunder

time 2.0

tool

linea collections

useful information



ash SW2 90x90 NR

LAMINATED
PORCELAIN
STONEWARE

FULL BODY
PORCELAIN

subway

collection



100x300
NR 3,5mm

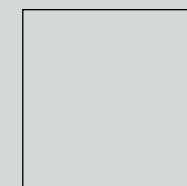

100x100
NR 3,5mm



90x90
NR 9,5mm

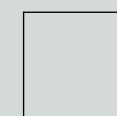

60x60
NR 8,5mm
A 8,5mm
E ASR 20mm



DOWNLOAD
CATALOGUE
OUTDOOR
EXTRA THICK



DOWNLOAD
CATALOGUE



DOWNLOAD
TECHNICAL
FEATURES



VIEW
ONLINE



ENJOY THE
VIDEO

rectified products . produits rectifiés . rektifizierete produkte . produtos retificados



white
SW1 . LSW1

ash
SW2 . LSW2

clay
LSW3

smoke
LSW4

UGL **V2** **R10** **R9**
E ASR NR LINEA

PR()TECT®

Antibacterial for Life.

MARGRES
CERAMIC TILES

index

colour map

collections

bare&bold

concept

deck plus

endless

evoke

evolution

fragment

grove

hybrid

metropolis

prestige

pure stone

slabstone

stage

subway

tecnica

thunder

time 2.0

tool

linea collections

useful information

subway

— collection



234

general catalogue . 2026

ash SW2 60x60 E ASR

subway

collection —



235

general catalogue . 2026

white SW1 90x90 NR

index



colour map



collections



bare&bold

concept

deck plus

endless

evoke

evolution

fragment

grove

hybrid

metropolis

prestige

pure stone

slabstone

stage

subway

tecnica

thunder

time 2.0

tool

linea collections



useful information



subway

collection



60x60	8,5mm	NR	R9	A	MG-2765
	8,5mm	A	-	-	MG-3070
	20mm	E ASR	R10	B	MG-7090
90x90	9,5mm	NR	R9	A	MG-3960
LINEA					
100x100	3,5mm	NR	R9	-	M3-1230
100x300	3,5mm	NR	R9	-	M3-1530



LINEA					
100x100	3,5mm	NR	R9	-	M3-1230
100x300	3,5mm	NR	R9	-	M3-1530

subway

collection

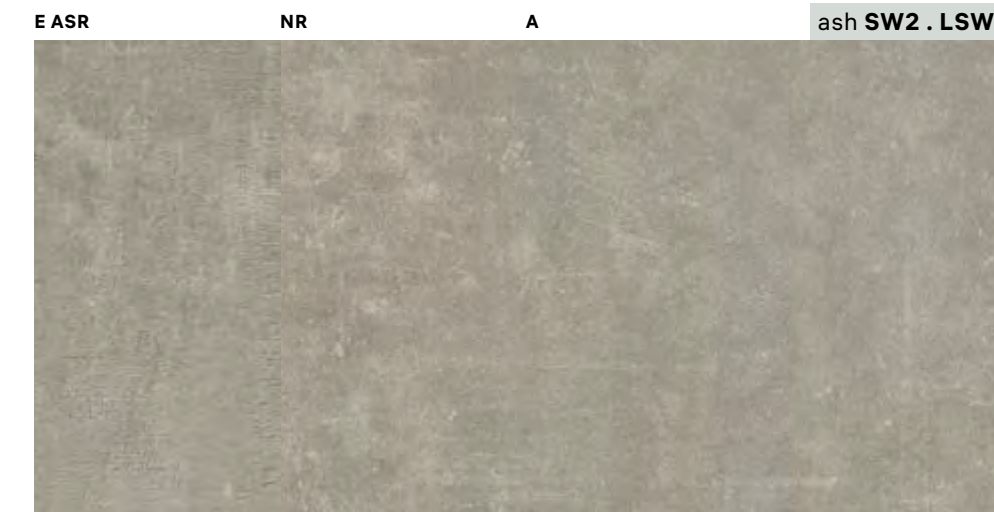

60x60	8,5mm	NR	R9	A	MG-2765
	8,5mm	A	-	-	MG-3070
	20mm	E ASR	R10	B	MG-7090
90x90	9,5mm	NR	R9	A	MG-3960
LINEA					
100x100	3,5mm	NR	R9	-	M3-1230
100x300	3,5mm	NR	R9	-	M3-1530

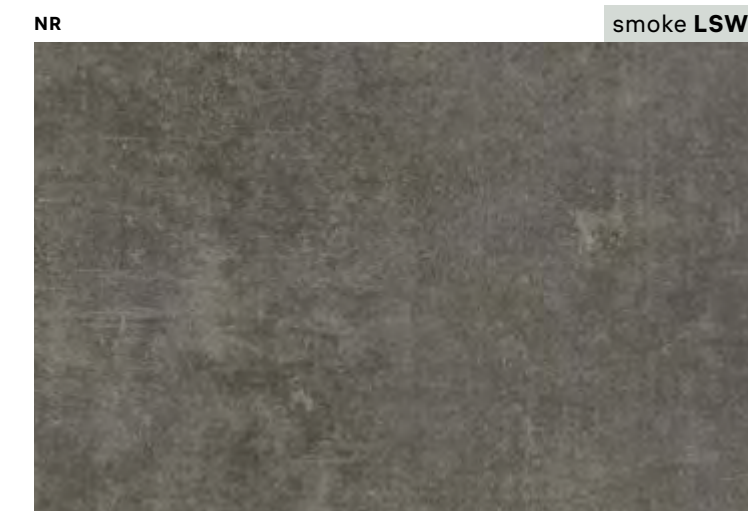

LINEA					
100x100	3,5mm	NR	R9	-	M3-1230
100x300	3,5mm	NR	R9	-	M3-1530

index

colour map

collections

bare&bold

concept

deck plus

endless

evoke

evolution

fragment

grove

hybrid

metropolis

prestige

pure stone

slabstone

stage

subway

tecnica

thunder

time 2.0

tool

PROTECT

Antibacterial for Life.

An exclusive line of extremely high performance antimicrobial floor and wall tiles, designed for healthy, safe and protected living spaces. Anti-slip finish doesn't have antibacterial protection.
 Une ligne exclusive de sols et revêtements antibactériens aux performances très élevées, pour un habitat sain, sûr et protégé. La finition antidérapante n'a pas de protection antibactérienne.
 Eine exklusive Linie an hochwertigen Fußböden und antibakteriellen Wandverkleidungen, für ein gesundes, sicheres und geschütztes Leben. Die rutschfeste Oberfläche hat keinen antibakteriellen Schutz.
 Uma linha exclusiva de pavimentos e revestimentos antimicrobianos de altíssima performance, projetada para ambientes saudáveis, seguros e protegidos. O acabamento antiderrapante não tem proteção antibacteriana.

linea collections

useful information

subway

collection

decors

décorations . dekorationen . decorações

8,5MM

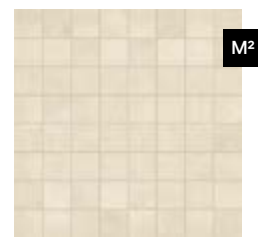

mosaic subway 3,5x3,5 white
30x30
NR MG-9590



mosaic subway 3,5x3,5 ash
30x30
NR MG-9590

8,5MM



bricks subway white
29,6x59,5
NR MP-6350



bricks subway ash
29,6x59,5
NR MP-6350

special pieces

pièces spéciales . spezialteile . peças especiais

9,5 . 8,5MM

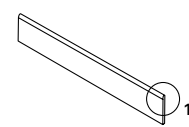
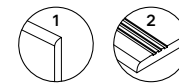

skirting
plinthe
sockel
rodapé

8x60
NR MP-6170
A MP-6180
8x90
NR MP-6260

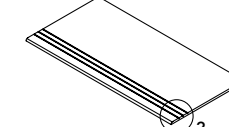

step tread grooved
nez de marche creusé
stufenplatte mit rillen
degrau sulcado

30x60
NR MP-6240
A MP-6270
30x90
NR MP-6430

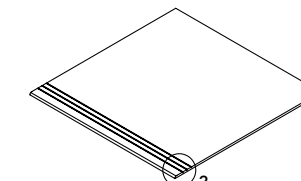

step tread grooved
nez de marche creusé
stufenplatte mit rillen
degrau sulcado

60x60
NR MP-6400
A MP-6430



8,5MM

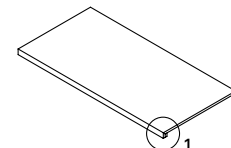
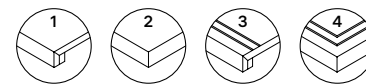

step tread "L"
nez de marche "L"
stufenplatte "L"
degrau "L"

30x60
NR . A MP-6560

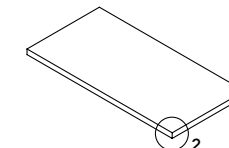

*
step tread "L" corner
nez de marche "L" angle
ecke stufenplatte "L"
degrau "L" canto

30x60
NR . A MP-6630

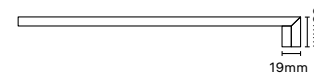

step tread "L" corner . nez de marche "L" angle
ecke stufenplatte "L" . degrau "L" canto

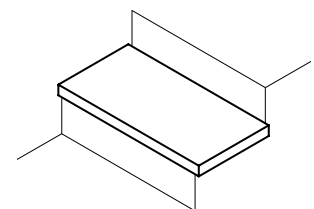

right corner . angle droit
rechten ecke . canto direito

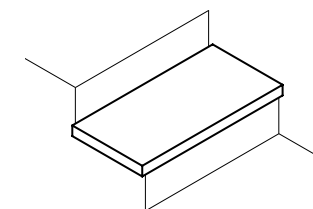

left corner . angle gauche
links ecke . canto esquerdo

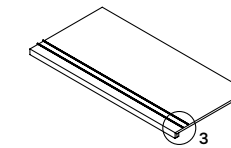

step tread "L" inox
nez de marche "L" inox
stufenplatte "L" inox
degrau "L" inox

30x60
NR . A MP-6580

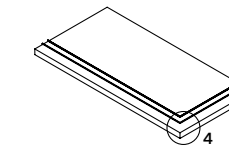

*
step tread "L" corner inox
nez de marche "L" angle inox
ecke stufenplatte "L" inox
degrau "L" canto inox

30x60
NR . A MP-6650



step tread "L" corner inox . nez de marche "L" angle inox
ecke stufenplatte "L" inox . degrau "L" canto inox

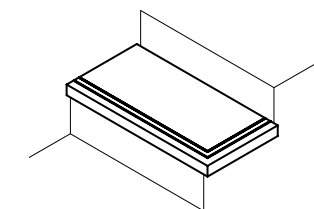

right corner . angle droit
rechten ecke . canto direito

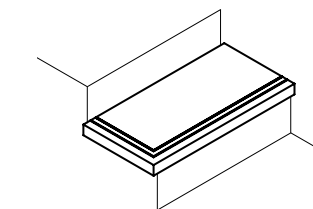

left corner . angle gauche
links ecke . canto esquerdo

Available in all colours
Disponible dans toutes les couleurs
Erhältlich in allen Farben
Disponível em todas as cores

*
Available in right and left corner
Disponible dans les coin droit et gauche
Erhältlich in der rechten Ecke und links
Disponível no canto direito e esquerdo

OUTDOOR

EXTRA THICK

Special 20MM pieces please refer to page 348.
Pièces spéciales 20MM, veuillez consulter la page 348.
Speziellanfertigungen 20MM siehe Seite 348.
Peças especiais 20MM, por favor consulte a página 348.

index

colour map

collections

bare&bold

concept

deck plus

endless

evoke

evolution

fragment

grove

hybrid

metropolis

prestige

pure stone

slabstone

stage

subway

tecnica

thunder

time 2.0

tool

linea collections

useful information

Mosaic and Brick decors are net mounted. All decors may feature shade variations regarding the corresponding floor/wall tile standard tile.
Les décorations Mosaic et Brick sont sur trame. Toutes les décorations peuvent souffrir variations de tonalité par rapport aux carreaux base.
Die Mosaic und Brick Dekoration liegen auf einem Netz. Alle Dekorationen können im Vergleich zu den jeweiligen Grundiesen Farbunterschiede aufweisen.
As decorações Mosaic and Brick são sobre rede. Todas as decorações podem sofrer variações de tonalidade em relação aos respectivos mosaicos base.

MARGRES
CERAMIC TILES



240

general catalogue . 2026

snow T21 60x60 P

LAMINATED
PORCELAIN
STONEWARE

TECHNICAL
FULL BODY
PORCELAIN

time 2.0

collection



100x300
NR 3,5mm

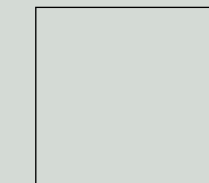

100x100
NR 3,5mm

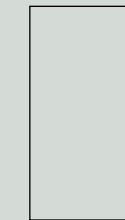

60x120
NR 11mm
P 10,5mm

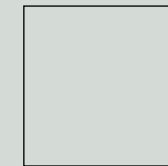

90x90
NR 11mm
P 10,5mm



60x60
NR 10mm
P 9,5mm
ASR 10mm
ENR 14mm



30x60
NR 10mm
P 9,5mm

- ↓
DOWNLOAD
BIM
- ↓
DOWNLOAD
CATALOGUE
- ↓
DOWNLOAD
TECHNICAL
FEATURES
- ↓
VIEW
ONLINE
- ↓
DOWNLOAD
CATALOGUE
OUTDOOR
EXTRA THICK

rectified products . produits rectifiés . rektifizierete produkte . produtos retificados

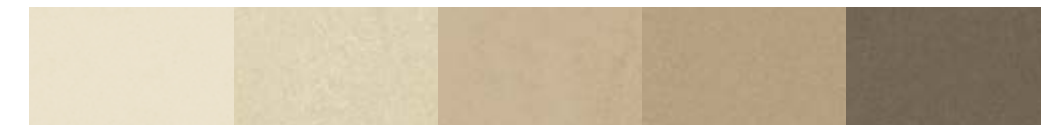

snow T21 . LT21 white T22 cream T23 . LT23 beige T24 . LT24 dove T25

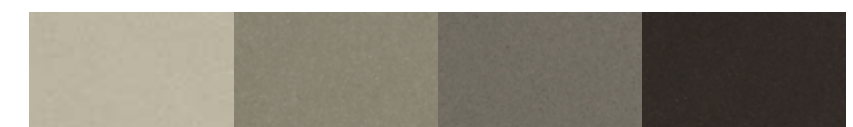

silver T26 . LT26 grey T27 carbon T28 . LT28 black T29 . LT29

UGL V1 R11 R10 R9 LINEA LINEA **BIM**



pour plus d'informations, consultez
<https://evaluation.cstb.fr>



Antibacterial for Life.



241

general catalogue . 2026

index

colour map

collections

- bare&bold
- concept
- deck plus
- endless
- evoke
- evolution
- fragment
- grove
- hybrid
- metropolis
- prestige
- pure stone
- slabstone
- stage
- subway
- tecnica
- thunder
- time 2.0**
- tool

linea collections

useful information



collections



bare&bold

concept

deck plus

endless

evoke

evolution

fragment

grove

hybrid

metropolis

prestige

pure stone

slabstone

stage

subway

tecnica

thunder

time 2.0

—
tool

linea collections



useful information

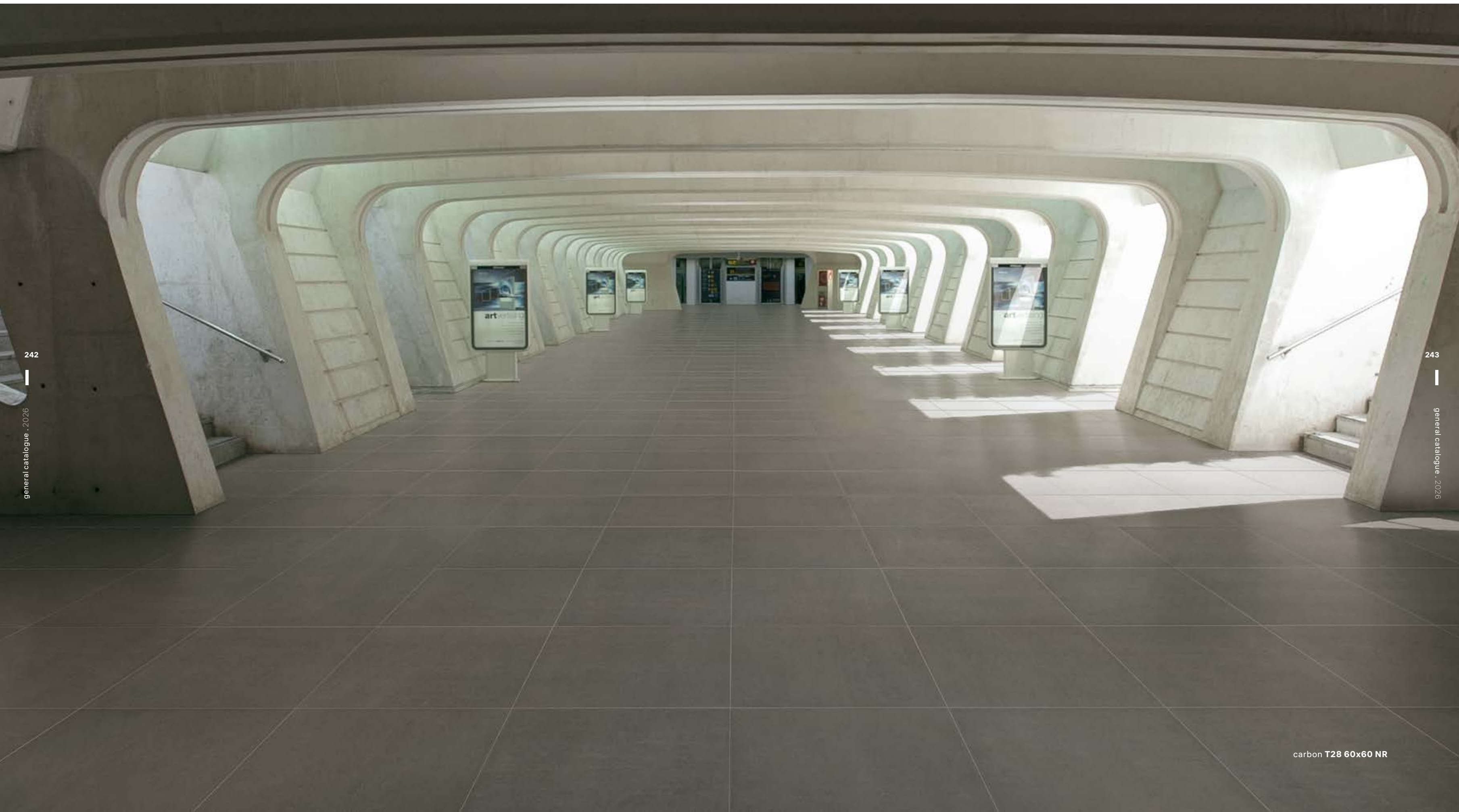

time 2.0

— collection



244

general catalogue 2026

black T29 60x60 P

time 2.0

collection —



245

general catalogue 2026

grey T27 30x60 NR

index



colour map



collections



bare&bold

concept

deck plus

endless

evoke

evolution

fragment

grove

hybrid

metropolis

prestige

pure stone

slabstone

stage

subway

tecnica

thunder

time 2.0

—
tool

linea collections



useful information



time 2.0

— collection



246

general catalogue, 2026

silver T26 60x60 ASR

time 2.0

— collection



247

general catalogue, 2026

grey T27 60x60 E NR

index



colour map



collections



bare&bold

concept

deck plus

endless

evoke

evolution

fragment

grove

hybrid

metropolis

prestige

pure stone

slabstone

stage

subway

tecnica

thunder

time 2.0

— tool

linea collections



useful information



time 2.0

— collection



30x60	10mm	NR	R10	B	MG-2205
	9,5mm	P	-	-	MG-2650
60x60	14mm	ENR	R10	B	MG-3475
	10mm	NR	R10	B	MG-2870
	10mm	ASR	R11	C	MG-2870
	9,5mm	P	-	-	MG-3330
90x90	11mm	NR	R10	B	MG-4045
	10,5mm	P	-	-	MG-4540
60x120	11mm	NR	R10	B	MG-4805
	10,5mm	P	-	-	MG-5250
LINEA					
100x100	3,5mm	NR	R9	-	M3-1230
100x300	3,5mm	NR	R9	-	M3-1530



30x60	10mm	NR	R10	B	MG-2105
	9,5mm	P	-	-	MG-2570
60x60	10mm	NR	R10	B	MG-2785
	9,5mm	P	-	-	MG-3250
60x120	11mm	NR	R10	B	MG-4760
	10,5mm	P	-	-	MG-5210



30x60	10mm	NR	R10	B	MG-2105
	9,5mm	P	-	-	MG-2570
60x60	14mm	ENR	R10	B	MG-3425
	10mm	NR	R10	B	MG-2785
	10mm	ASR	R11	C	MG-2785
	9,5mm	P	-	-	MG-3250
90x90	11mm	NR	R10	B	MG-3985
	10,5mm	P	-	-	MG-4485
60x120	11mm	NR	R10	B	MG-4760
	10,5mm	P	-	-	MG-5210
LINEA					
100x100	3,5mm	NR	R9	-	M3-1230
100x300	3,5mm	NR	R9	-	M3-1530

time 2.0

collection —

30x60	10mm	NR	R10	B	MG-2105
	9,5mm	P	-	-	MG-2570
60x60	10mm	NR	R10	B	MG-2785
	10mm	ASR	R11	C	MG-2785
	9,5mm	P	-	-	MG-3250
90x90	11mm	NR	R10	B	MG-3985
	10,5mm	P	-	-	MG-4485
LINEA					
100x100	3,5mm	NR	R9	-	M3-1230
100x300	3,5mm	NR	R9	-	M3-1530

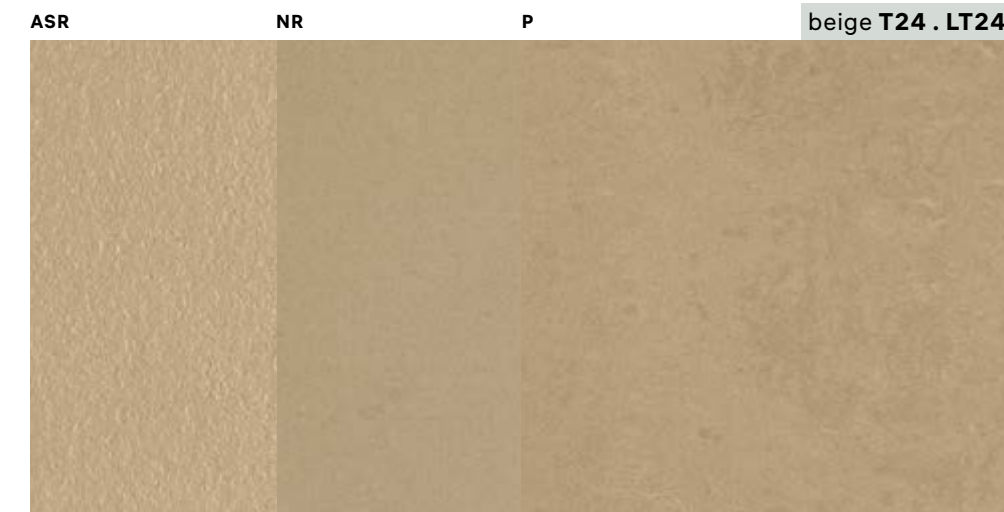

30x60	10mm	NR	R10	B	MG-2105
	9,5mm	P	-	-	MG-2570
60x60	10mm	NR	R10	B	MG-2785
	9,5mm	P	-	-	MG-3250



Products with a polished finish are more sensitive to abrasion and stains, what requires special conditions. Please see page 358 in chapter 09.
 Les produits à finition polie sont plus sensibles à l'abrasion et aux taches, ce qui requiert des conditions particulières. Veuillez-vous consulter la page 358 du chapitre 09.
 Produkte mit einer polierten Oberfläche sind empfindlicher gegen Abrieb und Fleckenbildung, was besondere Bedingungen erfordert. Bitte beachten Sie Seite 358 in Kapitel 09.
 Os produtos com acabamento polido são mais sensíveis à abrasão e às manchas, o que requer condições especiais. Por favor consulte a página 358 no capítulo 09.

MARGRES
 CERAMIC TILES

An exclusive line of extremely high performance antimicrobial floor and wall tiles, designed for healthy, safe and protected living spaces. Anti-slip finish doesn't have antibacterial protection.
 Une ligne exclusive de sols et revêtements antibactériens aux performances très élevées, pour un habitat sain, sûr et protégé. La finition antidérapante n'a pas de protection antibactérienne.
 Eine exklusive Linie an hochwertigen Fußböden und antibakteriellen Wandverkleidungen, für ein gesundes, sicheres und geschütztes Leben. Die rutschfeste Oberfläche hat keinen antibakteriellen Schutz.
 Uma linha exclusiva de pavimentos e revestimentos antimicrobianos de altíssima performance, projetada para ambientes saudáveis, seguros e protegidos. O acabamento antiderrapante não tem proteção antibacteriana.

PROTECT

Antibacterial for Life.

index

colour map

collections

bare&bold

concept

deck plus

endless

evoke

evolution

fragment

grove

hybrid

metropolis

prestige

pure stone

slabstone

stage

subway

tecnica

thunder

time 2.0

tool

linea collections

useful information

time 2.0

collection

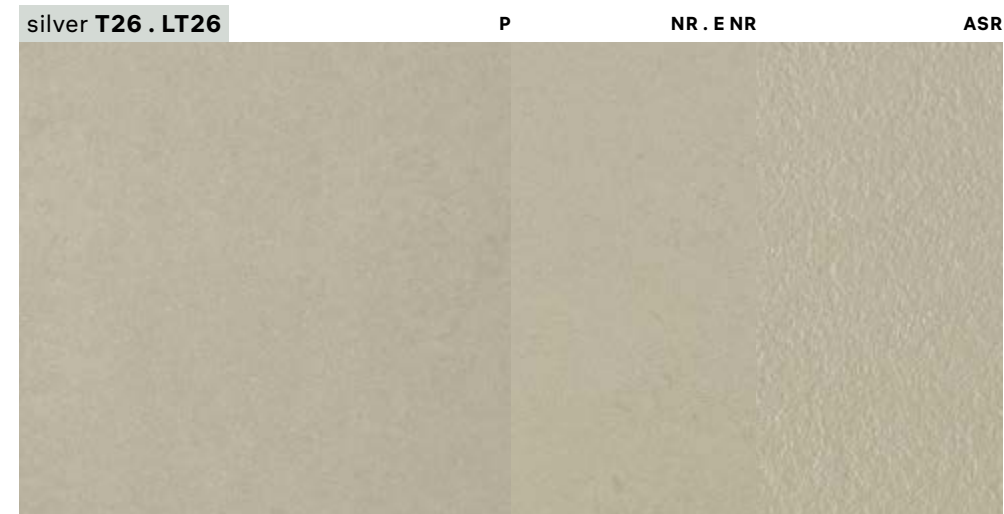

30x60	10mm	NR	R10	B	MG-2105
	9,5mm	P	-	-	MG-2570
60x60	14mm	ENR	R10	B	MG-3425
	10mm	NR	R10	B	MG-2785
	10mm	ASR	R11	C	MG-2785
	9,5mm	P	-	-	MG-3250
90x90	11mm	NR	R10	B	MG-3985
	10,5mm	P	-	-	MG-4485
60x120	11mm	NR	R10	B	MG-4760
	10,5mm	P	-	-	MG-5210
LINEA					
100x100	3,5mm	NR	R9	-	M3-1230
100x300	3,5mm	NR	R9	-	M3-1530



30x60	10mm	NR	R10	B	MG-2105
	9,5mm	P	-	-	MG-2570
60x60	14mm	ENR	R10	B	MG-3425
	10mm	NR	R10	B	MG-2785
	9,5mm	P	-	-	MG-3250
60x120	11mm	NR	R10	B	MG-4760
	10,5mm	P	-	-	MG-5210

time 2.0

collection

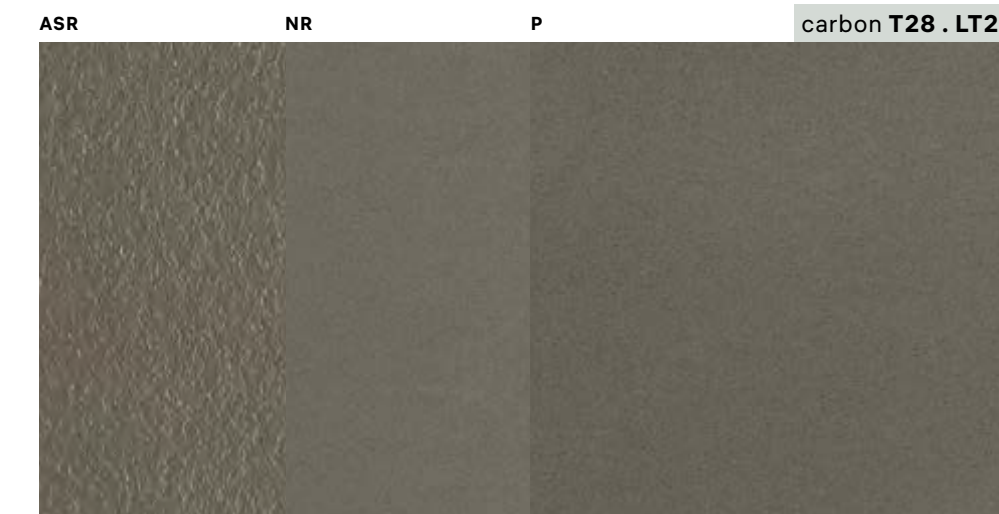

30x60	10mm	NR	R10	B	MG-2105
	9,5mm	P	-	-	MG-2570
60x60	10mm	NR	R10	B	MG-2785
	10mm	ASR	R11	C	MG-2785
	9,5mm	P	-	-	MG-3250
90x90	11mm	NR	R10	B	MG-3985
	10,5mm	P	-	-	MG-4485
LINEA					
100x100	3,5mm	NR	R9	-	M3-1230
100x300	3,5mm	NR	R9	-	M3-1530

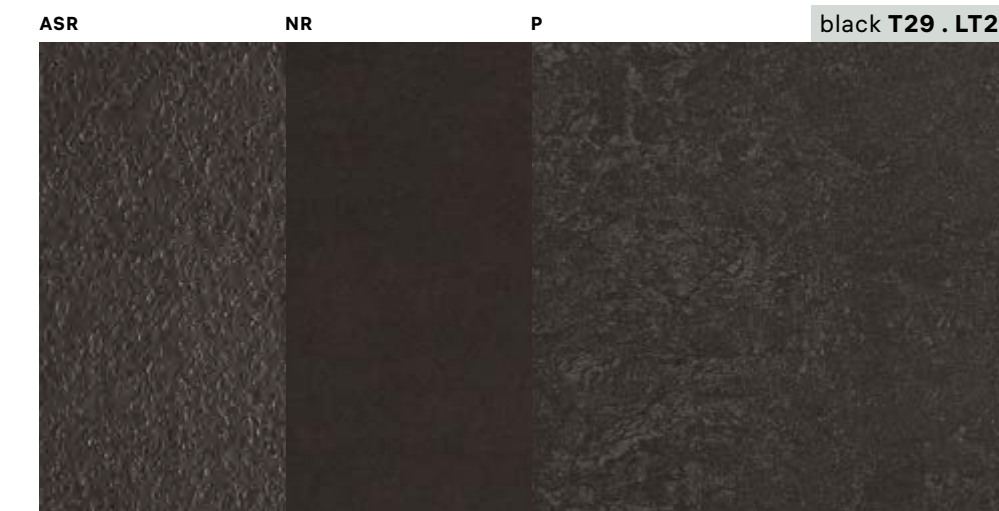

30x60	10mm	NR	R10	B	MG-2105
	9,5mm	P	-	-	MG-2570
60x60	10mm	NR	R10	B	MG-2785
	10mm	ASR	R11	C	MG-2785
	9,5mm	P	-	-	MG-3250
90x90	11mm	NR	R10	B	MG-3985
	10,5mm	P	-	-	MG-4485
60x120	11mm	NR	R10	B	MG-4760
	10,5mm	P	-	-	MG-5210
LINEA					
100x100	3,5mm	NR	R9	-	M3-1230
100x300	3,5mm	NR	R9	-	M3-1530

index

colour map

collections

bare&bold

concept

deck plus

endless

evoke

evolution

fragment

grove

hybrid

metropolis

prestige

pure stone

slabstone

stage

subway

tecnica

thunder

time 2.0

tool

Products with a polished finish are more sensitive to abrasion and stains, what requires special conditions. Please see page 358 in chapter 09.
Les produits à finition polie sont plus sensibles à l'abrasion et aux taches, ce qui requiert des conditions particulières. Veuillez-vous consulter la page 358 du chapitre 09.
Produkte mit einer polierten Oberfläche sind empfindlicher gegen Abrieb und Fleckenbildung, was besondere Bedingungen erfordert. Bitte beachten Sie Seite 358 in Kapitel 09.
Os produtos com acabamento polido são mais sensíveis à abrasão e às manchas, o que requer condições especiais. Por favor consulte a página 358 no capítulo 09.

PROTECT

Antibacterial for Life.

MARGRES
CERAMIC TILES

An exclusive line of extremely high performance antimicrobial floor and wall tiles, designed for healthy, safe and protected living spaces. Anti-slip finish doesn't have antibacterial protection.
Une ligne exclusive de sols et revêtements antibactériens aux performances très élevées, pour un habitat sain, sûr et protégé. La finition antidérapante n'a pas de protection antibactérienne.
Eine exklusive Linie an hochwertigen Fußböden und antibakteriellen Wandverkleidungen, für ein gesundes, sicheres und geschütztes Leben. Die rutschfeste Oberfläche hat keinen antibakteriellen Schutz.
Uma linha exclusiva de pavimentos e revestimentos antimicrobianos de altíssima performance, projetada para ambientes saudáveis, seguros e protegidos. O acabamento antiderrapante não tem proteção antibacteriana.

linea collections

useful information

time 2.0

collection

decors

décorations . dekorationen . decorações

✂ P 9,5MM . NR 10MM . ASR 10MM

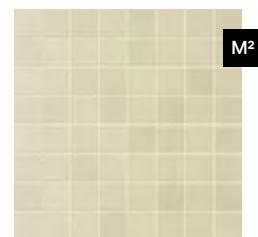

mosaic time 2.0 3,5x3,5
(all colours)
30x30
P MG-9835

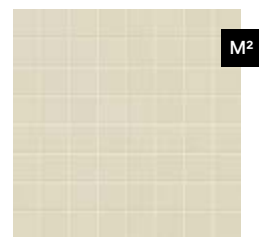

mosaic time 2.0 3,5x3,5
(all colours)
30x30
NR MG-9590

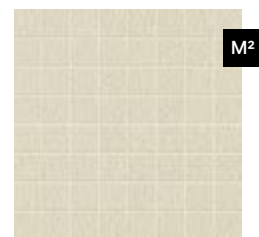

mosaic time 2.0
3,5x3,5*
30x30
ASR MG-9590

✂ NR 10MM

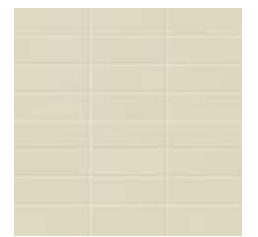

mosaic time 2.0 3,5x10
(all colours)
30x30
NR MP-6270

*
Available in colours Snow, Cream, Beige, Silver, Carbon and Black
Disponible dans les couleurs Snow, Cream, Beige, Silver, Carbon et Black
Erhältlich in den Farben Snow, Cream, Beige, Silver, Carbon und Black
Disponíveis nas cores Snow, Cream, Beige, Silver, Carbon e Black

Mosaic decors are net mounted. All decors may feature shade variations regarding the corresponding floor/wall tile standard tile.
La décoration Mosaic est sur trame. Toutes les décorations peuvent souffrir variations de tonalité par rapport aux carreaux base.
Die Mosaic Dekoration ist netzverklebt. Alle Dekorationen können im Vergleich zu den jeweiligen Grundiesen Farbunterschiede aufweisen.
A decoração Mosaic é sobre rede. Todas as decorações podem sofrer variações de tonalidade em relação aos respectivos mosaicos base.

special pieces

pièces spéciales . spezialteile . peças especiais

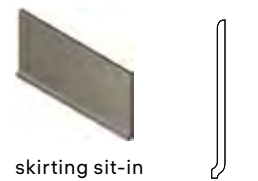

skirting sit-in
plinthe à gorge
hohlkehlsocbel
rodapé curvo
16x30
NR MP-6230

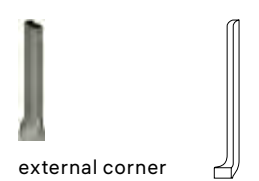

external corner
angle externe
aussenecke
canto externo
3,5x16
NR MP-6200

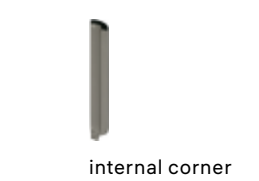

internal corner
angle interne
innenecke
canto interno
2,5x16
NR MP-6200



Skirting Sit-In and corners are glazed products.
La plinthe à gorge et ses angles sont des produits émaillés.
Der Hohlkehlsocbel und die jeweiligen Ecken sind emailliert.
O rodapé curvo e os respectivos cantos são produtos esmaltados.

MARGRES
CERAMIC TILES

time 2.0

collection

special pieces

pièces spéciales . spezialteile . peças especiais

✂ P 10,5 . 9,5MM . NR.ASR 11 . 10MM

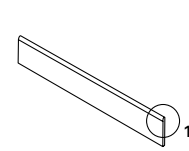

skirting
plinthe
sockel
rodapé

8x60
NR MP-6170
P MP-6180
8x90
NR* MP-6260
P* MP-6270
8x120
NR** MP-6260
P** MP-6270

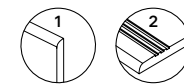

step tread grooved
nez de marche creusé
stufenplatte mit rillen
degrau sulcado

30x60
NR . ASR* MP-6240
P MP-6270
30x90
NR* MP-6430
P* MP-6445
30x120
NR** MP-6445
P** MP-6470

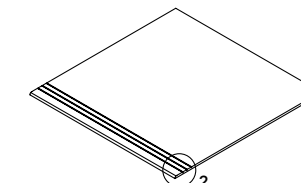

step tread grooved
nez de marche creusé
stufenplatte mit rillen
degrau sulcado

60x60
NR . ASR* MP-6400
P MP-6430



✂ P 10,5 . 9,5MM . NR.ASR 11 . 10MM

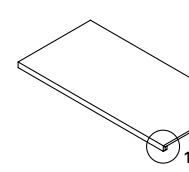

step tread "L"
nez de marche "L"
stufenplatte "L"
degrau "L"

30x60
NR . P MP-6560
30x120**
NR . P MP-6595

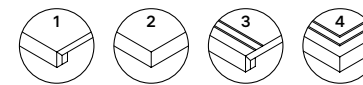

step tread "L" corner
nez de marche "L" angle
ecke stufenplatte "L"
degrau "L" canto

30x60
NR . P MP-6630
30x120**
NR . P MP-6655

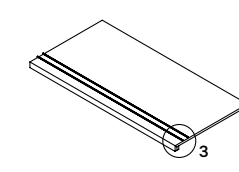

step tread "L" inox
nez de marche "L" inox
stufenplatte "L" inox
degrau "L" inox

30x60
NR . P MP-6580
30x120**
NR . P MP-6670

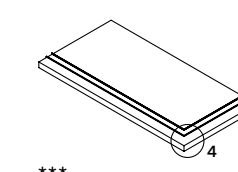

step tread "L" corner inox
nez de marche "L" angle inox
ecke stufenplatte "L" inox
degrau "L" canto inox

30x60
NR . P MP-6650
30x120**
NR . P MP-6710



step tread "L" corner . nez de marche "L" angle
ecke stufenplatte "L" . degrau "L" canto

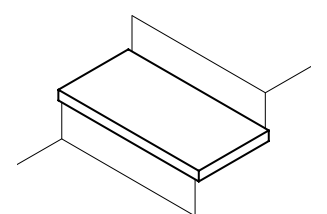

right corner . angle droit
rechten ecke . canto direito

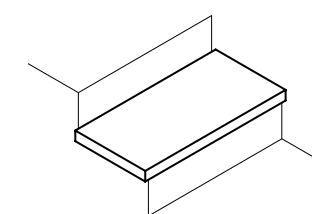

left corner . angle gauche
links ecke . canto esquerdo



step tread "L" corner inox . nez de marche "L" angle inox
ecke stufenplatte "L" inox . degrau "L" canto inox

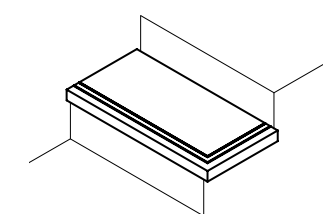

right corner . angle droit
rechten ecke . canto direito

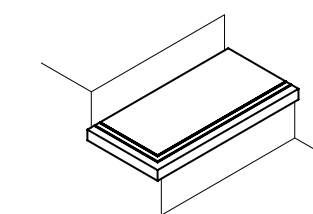

left corner . angle gauche
links ecke . canto esquerdo

*
Available in colours Snow, Cream, Beige, Silver, Carbon and Black
Disponible dans les couleurs Snow, Cream, Beige, Silver, Carbon et Black
Erhältlich in den Farben Snow, Cream, Beige, Silver, Carbon und Black
Disponíveis nas cores Snow, Cream, Beige, Silver, Carbon e Black

**
Available in colours Snow, White, Cream, Silver, Grey and Black
Disponible dans les couleurs Snow, White, Cream, Silver, Grey et Black
Erhältlich in den Farben Snow, White, Cream, Silver, Grey und Black
Disponíveis nas cores Snow, White, Cream, Silver, Grey e Black

Available in right and left corner
Disponible dans les coin droit et gauche
Erhältlich in der rechten Ecke und links
Disponível no canto direito e esquerdo

Dimension will vary depending on the base tile thickness.
La dimension varie selon l'épaisseur du carreau.
Das Maß variiert je nach Dicke der Fliese.
A dimensão varia consoante a espessura do material cerâmico.

index

colour map

collections

bare&bold

concept

deck plus

endless

evoke

evolution

fragment

grove

hybrid

metropolis

prestige

pure stone

slabstone

stage

subway

tecnica

thunder

time 2.0

tool

linea collections

useful information



254

general catalogue . 2026

granito beige 33 30x30 AS

TECHNICAL
FULL BODY
PORCELAIN

tecnic
collection

- ↓
DOWNLOAD
BIM
- ↓
DOWNLOAD
CATALOGUE
- ↓
DOWNLOAD
TECHNICAL
FEATURES
- 🌐
VIEW
ONLINE

□
30x30
N 8,5mm
AS 8,5mm
W 8,5mm
E 12mm

non-rectified product . produit non rectifié . nicht rektifiziert produkt . produto não retificado

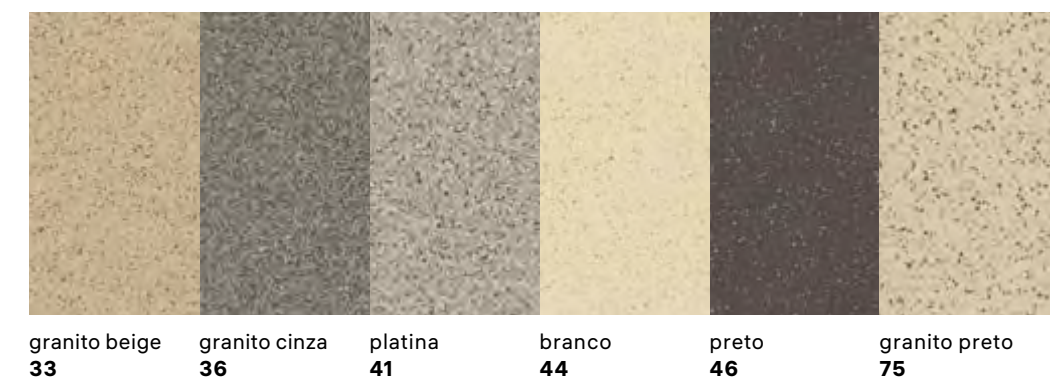

UGL **V0** **R11** **R10** **R9**
AS W N E

BIM

QB UPEC
pour plus d'informations, consultez
<https://evaluation.cstb.fr>

MARGRES
CERAMIC TILES

255

general catalogue . 2026

index

colour map

collections

- bare&bold
- concept
- deck plus
- endless
- evoke
- evolution
- fragment
- grove
- hybrid
- metropolis
- prestige
- pure stone
- slabstone
- stage
- subway
- tecnic**
- thunder
- time 2.0
- tool

linea collections

useful information

tecnic

collection

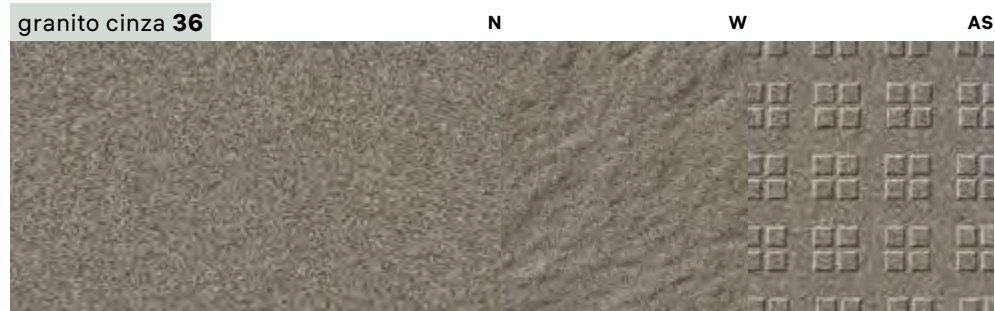

30x30	8,5mm	N	R9	-	MG-1015
	8,5mm	W	R10	C	MG-1015
	8,5mm	AS	R11	C	MG-1015

30x30	8,5mm	N	R9	-	MG-1015
	8,5mm	W	R10	C	MG-1015
	8,5mm	AS	R11	C	MG-1015

30x30	8,5mm	N	R9	-	MG-1015
	8,5mm	W	R10	C	MG-1015
	8,5mm	AS	R11	C	MG-1015
	12mm	E	R9	-	MG-1055

30x30	8,5mm	N	R9	-	MG-1040
	12mm	E	R9	-	MG-1080

30x30	8,5mm	N	R9	-	MG-1040
-------	-------	----------	----	---	---------

30x30	8,5mm	N	R9	-	MG-1015
	8,5mm	W	R10	C	MG-1015
	8,5mm	AS	R11	C	MG-1015
	12mm	E	R9	-	MG-1055

MARGRES
CERAMIC TILES

special finishings

finitions spéciales . speziellen fertigungs . acabamentos especiais

extra thick
forte épaisseur
überstärke fliese
espesurado

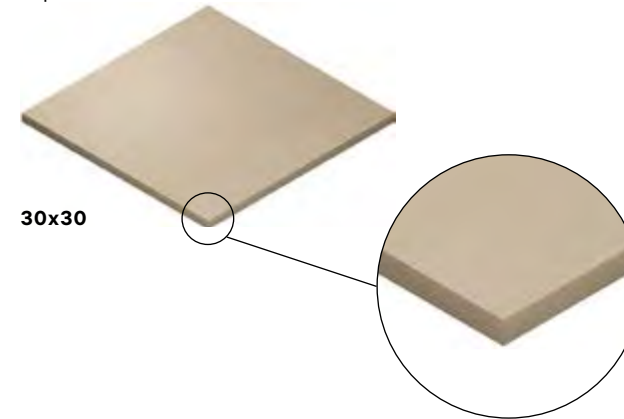

wavy
ondulé
wellig
ondulado

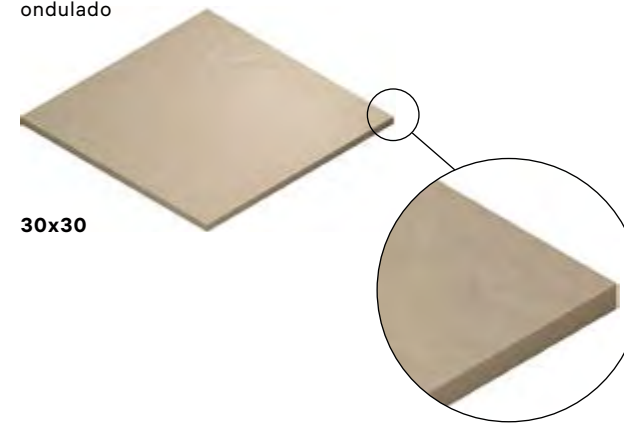

anti-slip
antidérapant
rutschfest
antiderrapante

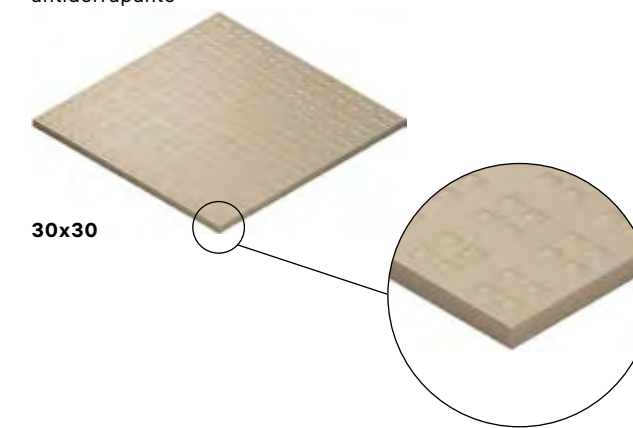

Nor all the presented colours are available in the finishings and indicated formats.
Les couleurs présentées ne sont pas disponibles dans toutes les formats et finitions indiqués.
Die vorhandenen Ausführungen und Formate sind nicht in allen abgebildeten Farben erhältlich.
Nem todas as cores apresentadas estão disponíveis nos acabamentos e formatos indicados.

special pieces

pièces spéciales . spezialteile . peças especiais

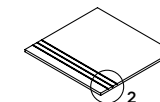
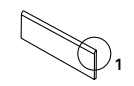
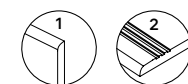

skirting
plinthe
sockel
rodapé
rodapé
9,5x30
N MP-6040

step tread grooved
nez de marche creusé
stufenplatte mit rillen
degrau sulcado
30x30
N MP-6080



Available in all colours
Disponible dans toutes les couleurs
Erhältlich in allen Farben
Disponível em todas as cores

tecnic

collection

index

colour map

collections

- bare&bold
- concept
- deck plus
- endless
- evoke
- evolution
- fragment
- grove
- hybrid
- metropolis
- prestige
- pure stone
- slabstone
- stage
- subway
- tecnic**
- thunder
- time 2.0
- tool

linea collections

useful information

LINEA

collections . kollektionen . coleções

cosmos	P. 297
endless	P. 275
evolution	P. 267
prestige	P. 309
pure stone	P. 289
slabstone	P. 313
subway	P. 317
time 2.0	P. 325
tool	P. 301

259

general catalogue . 2026

[index](#)

[colour map](#)

[collections](#)

linea collections

[cosmos](#)

[endless](#)

[evolution](#)

[prestige](#)

[pure stone](#)

[slabstone](#)

[subway](#)

[time 2.0](#)

[tool](#)

useful information

MARGRES
CERAMIC TILES



the new surface for avant-garde architecture

LINEA is the new generation of Margres' porcelain tiles which revolutionizes the concept of ceramics, creating new challenges for the use and designing of spaces where other materials were traditionally preferred. The revolutionary slabs of porcelain tile sheet are produced by means of innovative technology, which combines a pressing force of 15000 tonnes that transforms the purest clays and natural pigments into 3 meters by 1 meter ceramic plates, with **3,5mm, 5,5mm** and **6mm** thick.

Tiling for swimming pools, ventilated facades, thermal insulation cladding systems and for furniture surfaces. Depending on project specifications and in combination with the construction systems recommended by Margres and approved by the Installation Supervisor.

die neue oberfläche für avantgarde-architektur

LINEA ist die neue Generation des Feinsteinzeug von Margres, die das klassische Keramikkonzept revolutioniert und innovative Möglichkeiten der Raumaussnutzung und -gestaltung eröffnet, bei denen bisher andere Materialien bevorzugt wurden. Bei der Herstellung der bahnbrechenden dünnen Steinzeugplatten wird eine innovative Technologie angewandt, die reinen Ton und natürliche Pigmente mit 15.000 Tonnen Presskraft in nur **3,5mm, 5,5mm** und/oder **6mm** Stärke Keramikplatten von bis zu 3 Meter x 1 Meter verwandelt.

Becken und Schwimmbecken, Hinterlüftete Fassaden, Thermische Ummantelungen und Verkleidung von Oberflächen in der möbelbranchen. In Funktion der Projektangaben und in Kombination mit Konstruktionssystemen, die Margres vorgibt und die Arbeitsleitung genehmigt.

la nouvelle surface de l'architecture d'avant-garde

LINEA est la nouvelle génération de grès cérame Margres, qui révolutionne le concept de la céramique, en offrant de nouvelles possibilités d'utilisation et de conception des espaces, là où on utilisait auparavant d'autres matériaux. Des plaques révolutionnaires de grès cérame sont produites en utilisant une technologie innovatrice, qui transforme, par l'application d'une force de pressage de 15 000 tonnes, des argiles très pures et des pigments naturels en plaques de grès cérame de 3 mètres par 1 mètre, avec **3,5mm, 5,5mm** et **6mm** d'épaisseur à peine.

Revêtement bassins et piscines, façades ventilées, revêtements thermiques à mur-manteau et surfaces à revêtir dans le secteur de la décoration. En fonction des caractéristiques du projet et en combinaison avec les systèmes de construction indiqués par Margres et approuvés par les maîtres d'oeuvre.

a nova superfície para a arquitetura de vanguarda

LINEA é a nova geração de grés porcelânico Margres que revoluciona o próprio conceito da cerâmica, abrindo novas oportunidades de utilização e concepção do espaço, onde antes eram preferidos outros materiais. As revolucionárias placas grés lâmina, são produzidas com recurso a uma tecnologia inovadora, que transforma por meio de uma força de prensagem de 15.000 toneladas, argilas puríssimas e pigmentos naturais em placas cerâmicas de 3 metros por 1 metro com **3,5mm, 5,5mm** e **6mm** de espessura.

Revestimentos de banhos e piscinas, fachadas ventiladas, sistemas de revestimento de isolamento térmico e superfícies de revestimento no sector de decoração. Dependendo das características do projeto e em combinação com sistemas de construção indicadas pela Margres e aprovados pelo supervisor de obra.

advantages avantagens . vorteile . vantagens

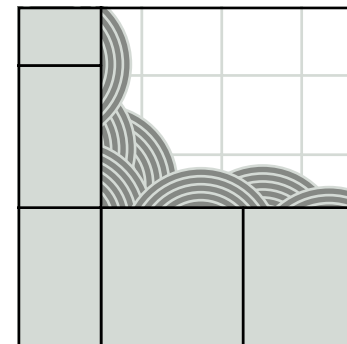

easy to install
facile à poser
einfach aufzutragen
fácil de aplicar

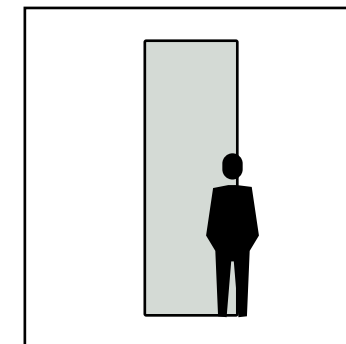

big
grand
groß
grande

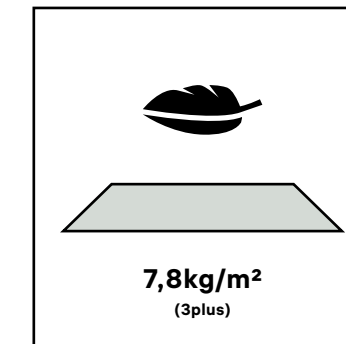

thin and light
fin et léger
dünn und leicht
fino e leve

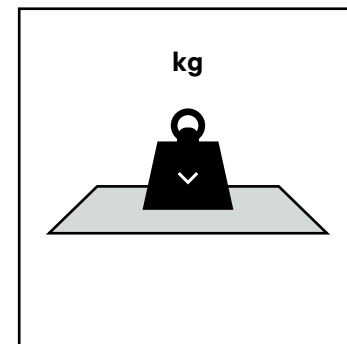

resistent
résistant
beständig
resistente

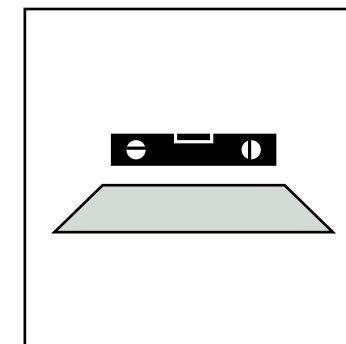

flat
lisse
flach
plano

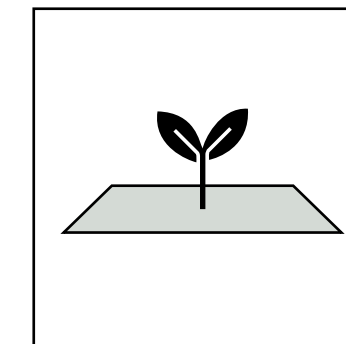

ecofriendly
écologique
ökologisch
ecológico

PROTECT®

Antibacterial for Life.

An exclusive line of extremely high performance antimicrobial floor and wall tiles, designed for healthy, safe and protected living spaces. Anti-slip finish doesn't have antibacterial protection.

Une ligne exclusive de sols et revêtements antibactériens aux performances très élevées, pour un habitat sain, sûr et protégé. La finition antidérapante n'a pas de protection antibactérienne.

Eine exklusive Linie an hochwertigen Fußböden und antibakteriellen Wandverkleidungen, für ein gesundes, sicheres und geschütztes Leben. Die rutschfeste Oberfläche hat keinen antibakteriellen Schutz.

Uma linha exclusiva de pavimentos e revestimentos antimicrobianos de altíssima performance, projetada para ambientes saudáveis, seguros e protegidos. O acabamento antiderrapante não tem proteção antibacteriana.

linea collections

cosmos

endless

evolution

prestige

pure stone

slabstone

subway

time 2.0

tool

useful information





an action to be tangible has to start from the basics, from the spaces we live in, from the decisions we make.

At the global level, buildings, homes, and the construction sector are today responsible for approximately 36% of the world's total energy consumption and 37% of all CO₂ emissions related to energy*.

Within this context, the construction sector can and must contribute to accelerating decarbonisation and developing alternative, low-CO₂ emission, solutions in an effort to achieve zero emissions by 2050. That's why choosing the right materials for residential, commercial, and public spaces is instrumental to decreasing our environmental impact.

Today, clients and designers must be increasingly meticulous when selecting construction materials and techniques, if there is to be any hope of achieving the Paris Agreement's objective of limiting global warming to 1.5°C.

*2021 GLOBAL STATUS REPORT FOR BUILDINGS AND CONSTRUCTION, Global Alliance for Buildings and Constructions.

eine aktion, die greifbar sein soll, muss bei den grundlagen beginnen, bei den räumen in denen wir leben, von den entscheidungen, die wir treffen.

Auf globaler Ebene sind Gebäude, Wohnungen und der Bausektor heute für etwa 36 % des weltweiten Gesamtenergieverbrauchs und 37 % aller energiebedingten CO₂-Emissionen verantwortlich*.

In diesem Zusammenhang kann und muß der Bausektor dazu beitragen, die Dekarbonisierung zu beschleunigen und alternative Lösungen mit geringen CO₂-Emissionen zu entwickeln, um bis zum Jahr 2050 Null-Emissionen zu erreichen. Deshalb ist die Wahl der richtigen Materialien für Wohn-, Geschäfts- und öffentliche Räume entscheidend für die Verringerung unserer Umweltbelastung.

Heutzutage, müssen Bauherren und Planer bei der Auswahl von Baumaterialien und -techniken immer sorgfältiger vorgehen, wenn das Ziel des Pariser Abkommens, die globale Erwärmung auf 1,5 °C zu begrenzen, erreicht werden soll.

*BERICHT ÜBER DIE GLOBALE SITUATION IM JAHR 2021 FÜR GEBÄUDE UND BAUWESEN, Globale Allianz für Gebäude und Bauwesen.

pour être tangible, une action doit partir de la base, des espaces dans lesquels nous vivons, des décisions que nous prenons.

A l'échelle mondiale, les bâtiments, les habitations et le secteur de la construction sont aujourd'hui responsables d'environ 36 % de la consommation totale d'énergie dans le monde et de 37 % de toutes les émissions de CO₂ liées à l'énergie*.

Dans ce contexte, le secteur de la construction peut et doit contribuer à l'accélération de la décarbonisation et au développement de solutions alternatives à faible émission de CO₂, dans le but d'atteindre l'objectif de zéro émission d'ici 2050. C'est pourquoi choisir les bons matériaux pour les espaces résidentiels, commerciaux et publics est essentiel pour réduire notre impact sur l'environnement.

Aujourd'hui, les maîtres d'ouvrage et les concepteurs doivent être de plus en plus méticuleux dans le choix des matériaux et des techniques de construction, s'ils veulent avoir un espoir d'atteindre l'objectif de l'Accord de Paris, qui consiste à limiter le réchauffement de la planète à 1,5°C.

*RAPPORT D'ÉTAPE GLOBAL 2021 SUR LES BÂTIMENTS ET LA CONSTRUCTION, Alliance mondiale pour les bâtiments et les constructions.

uma acção para ser tangível tem de começar a partir do que é básico, dos espaços em que vivemos, das decisões que tomamos.

A nível global, os edifícios, as casas e o setor da construção são hoje em dia responsáveis por aproximadamente 36% do consumo total de energia a nível mundial e por 37% de todas as emissões de CO₂ relacionadas com energia*.

Neste contexto, o setor da construção pode e tem de contribuir para acelerar a descarbonização e desenvolver soluções alternativas, com baixas emissões de CO₂, num esforço para se alcançar zero emissões até 2050. É por isso que a escolha dos materiais corretos para espaços residenciais, comerciais e públicos é fundamental para diminuir o nosso impacto ambiental.

Atualmente, os clientes e projetistas têm de ser cada vez mais meticulosos na seleção de materiais e técnicas de construção, para que haja alguma esperança de se alcançar o objetivo do Acordo de Paris de limitar o aquecimento global a 1,5°C.

*RELATÓRIO DA SITUAÇÃO GLOBAL EM 2021 RELATIVA A EDIFÍCIOS E CONSTRUÇÃO, Aliança Global para Edifícios e Construções.

we reduce the distance between us and zero impact, reducing everything in between

nous réduisons la distance qui nous sépare de l'impact zéro, en réduisant tout ce qui se trouve entre les deux
wir verringern den Abstand zwischen uns und der Nullbelastung und reduzieren alles, was dazwischen liegt
diminuimos a distância entre nós e o impacto zero, reduzindo tudo o que está no meio



consumption of raw materials
consommation de matières premières
verbrauch von rohstoffen
consumo de matérias primas



CO₂ emissions in the atmosphere
CO₂ émissions dans l'atmosphère
CO₂ emissionen in die atmosphäre
CO₂ emissões na atmosfera.



consumption of water
consommation d'eau
wasserverbrauch
consumo de água



consumption of energie
consommation d'énergie
energieverbrauch
o consumo de energia



pollution caused by transport
pollution produite par les transports
transportbedingte Umweltverschmutzung
poluição causada pelos transportes

The data refers to ultra-thin slabs when compared to standard-thickness porcelain stoneware tile
Les données se rapportent aux dalles ultrafines par rapport aux carreaux en grès cérame d'épaisseur standard
Die Daten beziehen sich auf ultradünne Platten im Vergleich zu Fliesen aus Feinsteinzeug mit Standarddicke
Os dados reportam-se a lajes ultrafinas, quando comparadas com mosaicos em grés porcelânico de espessura

our ultra-thin slabs. the most sustainable ceramic surface in the world with CO₂ compensated 100%.

Our ultra-thin slabs are born sustainable, but we didn't stop there. Because we've worked to reduce the CO₂ emissions generated by their production and compensate for residual emissions as well.

To go beyond. To achieve a zero-impact production, well beyond legal requirements.

Thus creating ultra-thin slabs that compensate for 100% of their CO₂ emissions is the world's most sustainable ceramic surface!

The thinnest tile on the market, at 3mm thick, is a testament to Panariagroup's leadership in the innovation of ceramic's natural sustainability.

unsere ultradünnen Platten. die nachhaltigste keramische oberfläche der welt mit 100% CO₂-Kompensation.

Unsere ultradünnen Platten werden bereits nachhaltig produziert, aber das war noch nicht alles. Denn wir haben daran gearbeitet, die bei ihrer Herstellung entstehenden CO₂-Emissionen zu reduzieren und auch die verbleibenden Emissionen zu kompensieren.

Um darüber hinauszugehen. Um eine umweltfreundliche Null-Emissionen-Produktion zu erreichen, die weit über die gesetzlichen Anforderungen hinausgeht. So haben wir ultradünne Platten geschaffen, die 100 % ihrer CO₂-Emissionen kompensieren: die nachhaltigste Keramikoberfläche der Welt!

Die dünnste Fliese auf dem Markt mit einer Dicke von 3 mm ist ein Beweis für die innovationsführende Rolle der Panariagroup im Bereich der natürlichen Nachhaltigkeit von Keramik.

nos dalles ultra-minces. la surface céramique la plus durable au monde avec une compensation de CO₂ à 100%.

Nos dalles ultra-minces sont déjà produites de manière durable, mais nous ne nous sommes pas arrêtés là. Car nous avons travaillé pour réduire les émissions de CO₂ générées par leur production et compenser également les émissions résiduelles. Pour aller plus loin. Pour atteindre une production à impact zéro, en allant bien au-delà des exigences légales.

En créant ainsi des dalles ultra-minces qui compensent 100 % de leurs émissions de CO₂, nous avons créé la surface céramique la plus durable du monde!

La mosaïque la plus fine du marché, d'une épaisseur de 3 mm, témoigne du leadership de Panariagroup en matière d'innovation dans le domaine de la durabilité naturelle de la céramique.

as nossas lajes ultrafinas. a superfície cerâmica mais sustentável do mundo, com 100% de compensação de CO₂.

As nossas lajes ultrafinas já são produzidas de forma sustentável, mas não nos ficámos por aí, uma vez que trabalhamos no sentido de reduzir as emissões de CO₂ geradas pela sua produção e também de compensar as emissões residuais. Para ir mais além. Para alcançar uma produção com impacto zero, ultrapassando largamente os requisitos legais.

Assim, a criação de lajes ultrafinas que compensam em 100% as suas emissões de CO₂ significa a criação da superfície cerâmica mais sustentável do mundo! O mosaico mais fino do mercado, com 3mm de espessura, é um testemunho da liderança da Panariagroup na inovação da sustentabilidade natural da cerâmica.

linea collections

cosmos

endless

evolution

prestige

pure stone

slabstone

subway

time 2.0

tool

useful information





intended uses

domaines d'emploi . verwendungszwecke . utilizações previstas

wall installation

pose au mur
wandverlegung
aplicação em revestimento

		LIN3A 3mm (3 plus)	LIN3A 5,5mm (3 plus)	LIN3A 6mm
<p>For new buildings and refurbishing with installation on existing walls. Application dans des nouvelles constructions ou des restructurations avec pose sur des murs préexistants. Anwendungen sowohl in neubauten wie auch renovierungen mit Verlegung auf vorhandenen Wände. Aplicação em novas construções ou intervenções em obras de restauro, com sobreposição do material em revestimentos preexistentes.</p>				
<p>interiors intérieur innenbereiche interiores</p> <p>Any residential and commercial. Toute zone résidentielle et commerciale. Fuer jede Wohn- und Handelsbereich. Qualquer área residencial e comercial.</p> 		■	■	■
<p>exteriors extérieur aussenbereiche exteriores</p> <p>On concrete or plaster supports, where corner cuts and large sizes are necessary not larger than 120x120 cm. Sur chape en béton ou enduit où il est nécessaire d'exécuter des découpes angulaires et d'utiliser de grands formats non supérieurs à 120x120 cm. Auf Untergründen aus Beton oder Putz, auf denen Eckschnitte gefertigt und Großformate verwendet werden müssen, nicht größer als 120x120 cm . Em bases de cimento ou reboco, onde é necessária a realização de cortes angulares e/ou aplicar formatos de grandes dimensões não superiores a 120x120cm.</p> 		■	■	■

special uses

utilisations spéciales . spezielle verwendungszwecke . aplicações especiais

Tiling for swimming pools, ventilated facades, thermal insulation cladding systems and for furniture surfaces.
Depending on project specifications and in combination with the construction systems recommended by Margres and approved by the Installation Supervisor.

Revêtement bassins et piscines, façades ventilées, revêtements thermiques à mur-manteau et surfaces à revêtir dans le secteur de la décoration.
En fonction des caractéristiques du projet et en combinaison avec les systèmes de construction indiqués par Margres et approuvés par les maîtres d'oeuvre.

Becken und Schwimmbecken, Hinterlüftete Fassaden, Thermische Ummantelungen und Verkleidung von Oberflächen in der möbelbranchen.
In Funktion der Projektangaben und in Kombination mit Konstruktionssystemen, die Margres vorgibt und die Arbeitsleitung genehmigt.

Revestimentos de banhos e piscinas, fachadas ventiladas, sistemas de revestimento de isolamento térmico e superfícies de revestimento no sector de decoração.
Dependendo das características do projeto e em combinação com sistemas de construção indicadas pela Margres e aprovados pelo supervisor de obra.

intended uses

domaines d'emploi . verwendungszwecke . utilizações previstas

floor installation

pose au sol
bodenverlegung
aplicação em pavimento

		LIN3A 3mm (3 plus)	LIN3A 5,5mm (3 plus)	LIN3A 6mm
<p>For new buildings and refurbishing with installation on existing floors. Not recommended the use of formats above 120x120cm. Application dans des nouvelles constructions ou des restructurations avec pose sur des sols préexistants. Il est déconseillé l'utilisation des formats supérieurs à 120x120cm. Für neubauten und renovierungen mit Verlegung auf vorhandenen Böden. Die Benutzung von Formaten die grösser sind als 120x120 wird nicht empfohlen. Aplicação em novas construções ou intervenções em obras de restauro, com sobreposição do material em pavimentos pre-existentes. Não é recomendado a utilização de formatos superiores a 120x120cm.</p>				
<p>Residential (kitchens, bathrooms, living rooms, common apartment block areas and any other residential environment) with the exception of areas subject to heavy loads (e.g. trolleys with hard wheels). Résidentiel (cuisines, salles de bains, salles de séjour, zones de copropriété collectives, et tout autre espace à usage résidentiel). Sauf les zones soumises au passage de charges lourdes concentrées (ex.: chariots à roues dures). Wohnbereiche (Küchen, Badezimmer, Wohnzimmer, Gemeinschaftsflächen in Mehrfamilienhäusern und alle sonstigen Wohnbereiche). Ausgenommen Bereiche mit Durchfahrtsverkehr von konzentrierten Schwerlasten (z.B. Wagen mit Hartgummirädern). Utilização residencial (cozinhas, casas de banho, salas de estar, áreas comuns de condomínios e em qualquer outro ambiente de uso residencial), excluindo zonas sujeitas a passagem de cargas pesadas concentradas (por exemplo, carrinhos com rodas rígidas).</p>		■	■	■
<p>Light commercial (offices, offices open to the general public, waiting rooms, shops, bathrooms, restaurant dining rooms, car showrooms, bars, cinemas, surgeries/clinics) with the exception of areas subject to heavy loads (e.g. trolleys with hard wheels). Traffic moderé (bureaux, bureaux ouverts au public, salles d'attente, magasins, salles de bains, salles de restaurants, salons automobiles, bars, cinémas, dispensaires/cliniques). Sauf les zones soumises au passage de charges lourdes concentrées (ex.: chariots à roues dures). Leichte gewerbliche anwendungen (Büroräume, öffentliche Büros, Wartezimmer, Geschäfte, Toiletten, Gaststätten, Autohäuser, Cafés, Kinos, Praxen/Kliniken). Ausgenommen Bereiche mit Durchfahrtsverkehr von konzentrierten Schwerlasten (z.B. Wagen mit Hartgummirädern). Utilização comercial ligeira (escritórios, escritórios abertos ao público, salas de espera, lojas, casas de banho, salas de restaurantes, stands de automóveis, bares, cinemas, centros de saúde/ clínicas), excluindo zonas sujeitas a passagem de cargas pesadas concentradas (por exemplo, carrinhos com rodas rígidas).</p>		■	■	■
<p>Heavy duty commercial (public areas of shopping centres, hotel halls, canteens, fast food restaurants, clubs, hospitals) with the exception of areas subject to heavy loads (e.g. trolleys with hard wheels). Commercial intensif (zones communes de centres commerciaux, halls d'hôtels, cantines, fast-foods, discothèques, hôpitaux). Sauf les zones soumises au passage de charges lourdes concentrées (ex.: chariots à roues dures). Intensive gewerbliche anwendungen (Gemeinschaftsbereiche in Einkaufszentren, Hotelhallen, Kantinen, Fastfood-Restaurants, Diskotheken, Krankenhäuser). Ausgenommen Bereiche mit Durchfahrtsverkehr von konzentrierten Schwerlasten (z.B. Wagen mit Hartgummirädern). Utilização comercial intensiva (áreas comuns de centros comerciais, lobbies de hotéis, cantinas, restaurantes de fastfood, discotecas, hospitais), excluindo zonas sujeitas a passagem de cargas pesadas concentradas (por exemplo, carrinhos com rodas rígidas).</p>			■	■

interiors
intérieur
innenbereiche
interiores



Installation must be performed in compliance with the standards published on the Margres Technical Manual.
La pose doit être effectuée selon les normes publiées dans le Manuel Technique Margres.
Die Verlegung muss nach den Vorschriften im Technischen Handbuch von Margres erfolgen.
A aplicação deve ser realizada em conformidade com as normas publicadas no Manual Técnico Margres.

linea collections

cosmos

endless

evolution

prestige

pure stone

slabstone

subway

time 2.0

tool





black LEN4 120x120 A . white LEN1 120x120 A

LAMINATED
PORCELAIN
STONEWARE

linea evolution

collection —
P. 57

- ↓
DOWNLOAD
BIM
- ↓
DOWNLOAD
CATALOGUE
- ↓
DOWNLOAD
TECHNICAL
FEATURES
- 🌐
VIEW
ONLINE

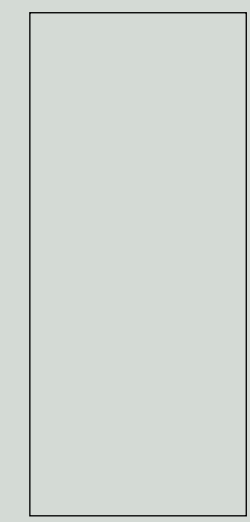

120x278
A 6mm

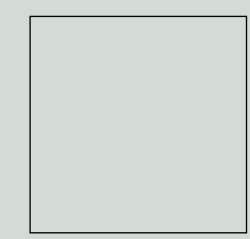

120x120
A 6mm

rectified products . produits rectifiés . rektifizierte produkte . produtos retificados



white
LEN1 beige
LEN2 light grey
LEN3 black
LEN4

UGL V2 **BIM**

PR()TECT
Antibacterial for Life.

MARGRES
CERAMIC TILES



index —

colour map —

collections —

linea collections

- cosmos
- endless
- evolution**
- prestige
- pure stone
- slabstone
- subway
- time 2.0
- tool

useful information

linea evolution

— collection

linea evolution

collection —

index



colour map



collections



linea collections



cosmos

endless

evolution

prestige

pure stone

slabstone

subway

time 2.0

tool

useful information



268

general catalogue . 2026

269

general catalogue . 2026

beige LEN2 120x278 A . 120x120 A . black LEN4 120x278 A





linea collections



cosmos

endless

evolution

prestige

pure stone

slabstone

subway

time 2.0

tool

useful information



270

general catalogue . 2026

271

general catalogue . 2026

light grey LEN3 120x278 A . 120x120 A



linea evolution

— collection

white LEN1



beige LEN2



120x120	6mm	A	-	-	M3-6780
120x278	6mm	A	-	-	M3-8270

120x120	6mm	A	-	-	M3-6780
120x278	6mm	A	-	-	M3-8270

linea evolution

collection —

light grey LEN3



black LEN4



120x120	6mm	A	-	-	M3-6780
120x278	6mm	A	-	-	M3-8270

120x120	6mm	A	-	-	M3-6780
120x278	6mm	A	-	-	M3-8270

index

colour map

collections

linea collections

cosmos

endless

evolution

prestige

pure stone

slabstone

subway

time 2.0

tool

useful information

272

273

general catalogue . 2026

general catalogue . 2026

MARGRES
CERAMIC TILES

PROTECT
Antibacterial for Life.

An exclusive line of extremely high performance antimicrobial floor and wall tiles, designed for healthy, safe and protected living spaces.
Une ligne exclusive de sols et revêtements antibactériens aux performances très élevées, pour un habitat sain, sûr et protégé.
Eine exklusive Linie an hochwertigen Fußböden und antibakteriellen Wandverkleidungen, für ein gesundes, sicheres und geschütztes Leben.
Uma linha exclusiva de pavimentos e revestimentos antimicrobianos de altíssima performance, projetada para ambientes saudáveis, seguros e protegidos.





274

general catalogue . 2026

calacatta gold LED1 100x300 SM . 100x100 SM . port black LED4 P

LAMINATED
PORCELAIN
STONEWARE

linea endless

collection —
P. 125

- ↓
DOWNLOAD
BIM
- ↓
DOWNLOAD
CATALOGUE
- ↓
DOWNLOAD
TECHNICAL
FEATURES
- 🌐
VIEW
ONLINE



100x300
SM . P 5,5mm



100x250
SM . P 5,5mm

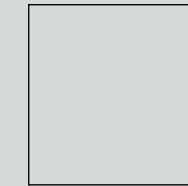

100x100
SM . P 5,5mm

rectified products . produits rectifiés . rektifizierte produkte . produtos retificados

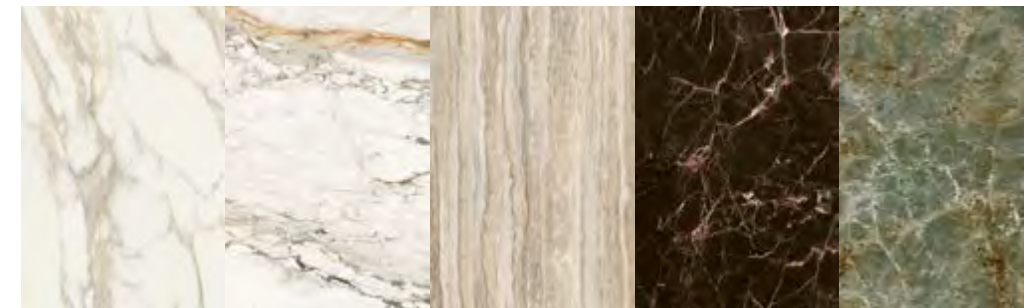



calacatta gold
LED1

breccia capraia
LED2

travertino
LED3

port black
LED4

amazonite
LED5

UGL V2  

BIM

PR()TECT®

Antibacterial for Life.

MARGRES
CERAMIC TILES



index

colour map

collections

linea collections

cosmos

endless

evolution

prestige

pure stone

slabstone

subway

time 2.0

tool

275

general catalogue . 2026

useful information

linea endless

— collection



276

general catalogue . 2026

linea endless

collection —



277

general catalogue . 2026

breccia capraia LED2 100x300 SM . 100x100 SM

index



colour map



collections



linea collections



cosmos

endless

evolution

prestige

pure stone

slabstone

subway

time 2.0

tool

useful information



linea endless

collection

linea endless

collection

index

colour map

collections

linea collections

cosmos

endless

evolution

prestige

pure stone

slabstone

subway

time 2.0

tool

useful information

278

general catalogue . 2026

279

general catalogue . 2026

chain breccia capraia LED2 100x300 P



linea endless

— collection



280

general catalogue . 2026

linea endless

collection —



281

general catalogue . 2026

travertino LED3 100x300 SM . 100x100 SM

index



colour map



collections



linea collections



cosmos

endless

evolution

prestige

pure stone

slabstone

subway

time 2.0

tool

useful information



linea endless

— collection

linea endless

collection —

index

—

colour map

—

collections

—

linea collections

—

cosmos

endless

evolution

prestige

pure stone

slabstone

subway

time 2.0

tool

useful information

—

282
general catalogue . 2026

283
general catalogue . 2026

chain amazonite LED5 100x300 P . port black LED4 100x100 P



linea endless

— collection

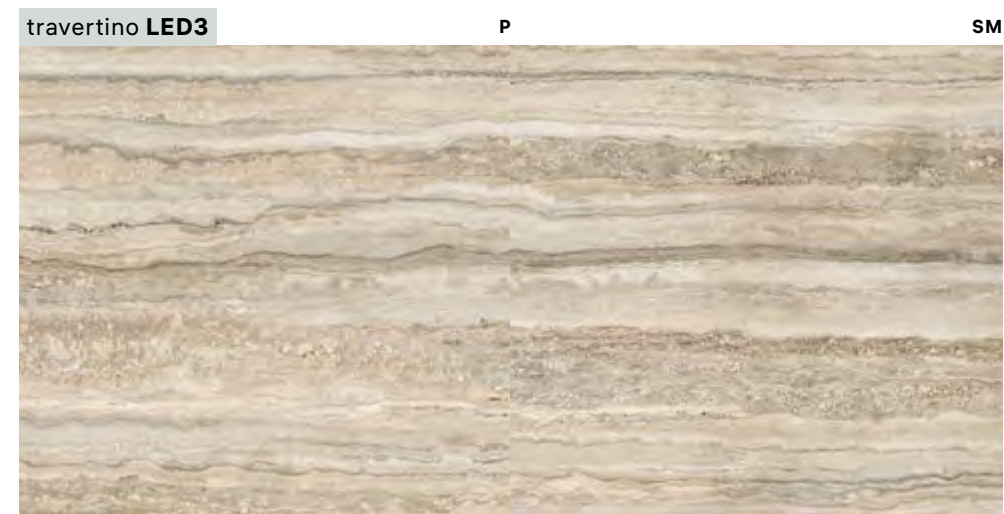
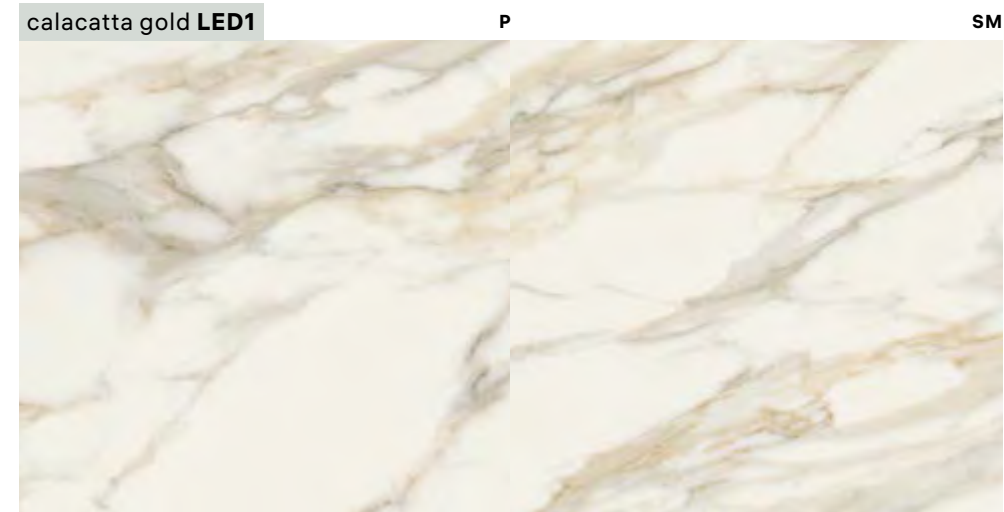

100x100	5,5mm	SM	-	-	M3-2730
	5,5mm	P	-	-	M3-3130
100x250	5,5mm	SM	-	-	M3-3530
	5,5mm	P	-	-	M3-3830
100x300	5,5mm	SM	-	-	M3-4230
	5,5mm	P	-	-	M3-4630

100x100	5,5mm	SM	-	-	M3-2730
	5,5mm	P	-	-	M3-3130
100x250	5,5mm	SM	-	-	M3-3530
	5,5mm	P	-	-	M3-3830
100x300	5,5mm	SM	-	-	M3-4230
	5,5mm	P	-	-	M3-4630

100x100	5,5mm	SM	-	-	M3-2730
	5,5mm	P	-	-	M3-3130
100x250	5,5mm	SM	-	-	M3-3530
	5,5mm	P	-	-	M3-3830
100x300	5,5mm	SM	-	-	M3-4230
	5,5mm	P	-	-	M3-4630

100x100	5,5mm	P	-	-	M3-3130
100x250	5,5mm	P	-	-	M3-3830
100x300	5,5mm	P	-	-	M3-4630

100x100	5,5mm	P	-	-	M3-3130
100x250	5,5mm	P	-	-	M3-3830
100x300	5,5mm	P	-	-	M3-4630

linea endless

collection —

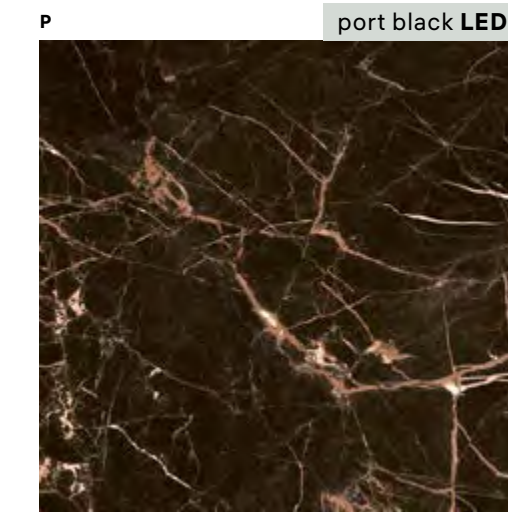

index

colour map

collections

linea collections

cosmos

endless

evolution

prestige

pure stone

slabstone

subway

time 2.0

tool

useful information

Products with a polished finish are more sensitive to abrasion and stains, what requires special conditions. Please see page 358 in chapter 09.
 Les produits à finition polie sont plus sensibles à l'abrasion et aux taches, ce qui requiert des conditions particulières. Veuillez-vous consulter la page 358 du chapitre 09.
 Produkte mit einer polierten Oberfläche sind empfindlicher gegen Abrieb und Fleckenbildung, was besondere Bedingungen erfordert. Bitte beachten Sie Seite 358 in Kapitel 09.
 Os produtos com acabamento polido são mais sensíveis à abrasão e às manchas, o que requer condições especiais. Por favor consulte a página 358 no capítulo 09.

PROTECT

Antibacterial for Life.

An exclusive line of extremely high performance antimicrobial floor and wall tiles, designed for healthy, safe and protected living spaces.
 Une ligne exclusive de sols et revêtements antibactériens aux performances très élevées, pour un habitat sain, sûr et protégé.
 Eine exklusive Linie an hochwertigen Fußböden und antibakteriellen Wandverkleidungen, für ein gesundes, sicheres und geschütztes Leben.
 Uma linha exclusiva de pavimentos e revestimentos antimicrobianos de altíssima performance, projetada para ambientes saudáveis, seguros e protegidos.



MARGRES
 CERAMIC TILES

linea endless

— collection

chain breccia capraia LED2



A

B

C

D

E

100x300 5,5mm P - - M3-4930

chain amazonite LED5

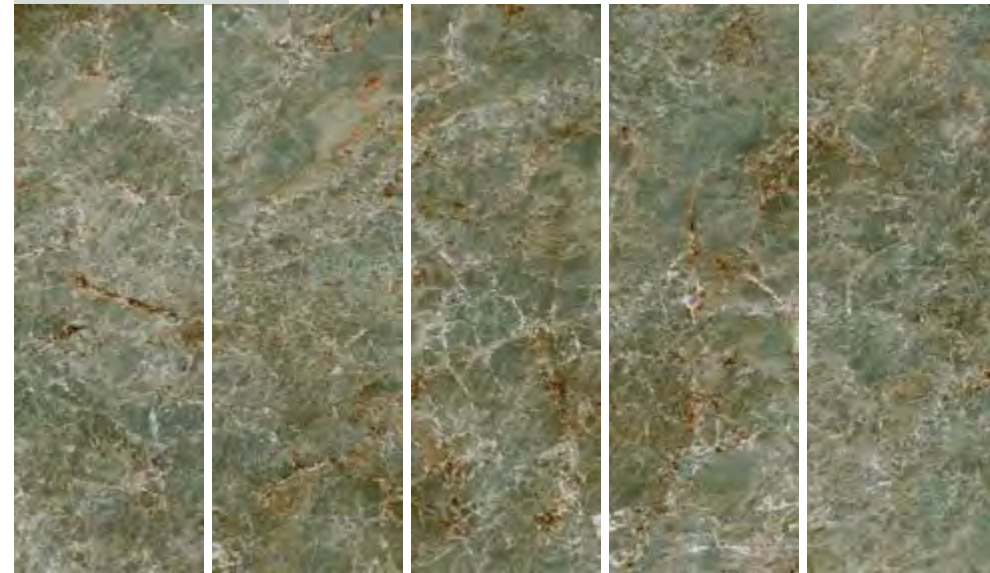

A

B

C

D

E

100x300 5,5mm P - - M3-4930



linea endless

collection —

index

colour map

collections

linea collections

cosmos

endless

evolution

prestige

pure stone

slabstone

subway

time 2.0

tool

useful information

Can only be purchased as complete composition.

Cette composition ne peut être vendue séparément, mais en un ensemble unique.

Nur in voller Zusammensetzung erhältlich.

Só pode ser adquirido como conjunto completo.

The picture is purely illustrative. The graphic design of **chain** may result in discontinuities in the veining between panels, as with the natural material. Discontinuities of up to 1,5 cm are not defects, but are characteristic of the product.

L'image n'est donnée qu'à titre indicatif. Le graphisme de **chain** peut présenter une discontinuité du veinage dans le passage entre les dalles, tout comme le matériau naturel. Toute différence jusqu'à 1,5 cm doit donc être considérée comme une caractéristique du produit.

Die Abbildung ist rein indikativ. Die Grafik **chain** kann wie beim natürlichen Material Maserungs-Diskontinuitäten beim Übergang zwischen den Platten aufweisen. Eventuelle Unterschiede bis zu 1,5 cm gelten daher als produkttypisch.

A imagem é puramente indicativa. O desenho gráfico do **chain** pode mostrar uma descontinuidade do veio na transição entre painéis cerâmicos, tal como no material natural. Quaisquer diferenças até 1,5 cm devem ser consideradas como uma característica do produto.

MARGRES
CERAMIC TILES

amazonite LED5 100x300 P . 100x100 P





beige LPS2 100x300 NR . grey LPS4 100x300 NR . 100x100 NR

LAMINATED
PORCELAIN
STONEWARE

linea pure stone

collection —
P. 137

- ↓
DOWNLOAD
BIM
- ↓
DOWNLOAD
CATALOGUE
- ↓
DOWNLOAD
TECHNICAL
FEATURES
- 🌐
VIEW
ONLINE



100x300
NR 6mm



100x250
NR 6mm

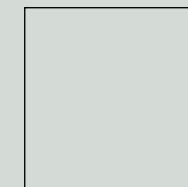

100x100
NR 6mm

rectified products . produits rectifiés . rektifizierte produkte . produtos retificados

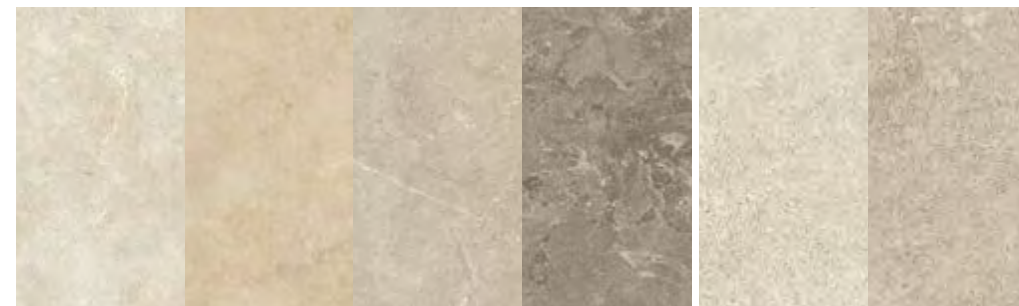

white LPS1 beige LPS2 light grey LPS3 grey LPS4 forge white LPS1F forge light grey LPS3F

UGL V2 R10 R9 🧑🧑🧑
FORGE NR



PR()TECT®
Antibacterial for Life.

MARGRES
CERAMIC TILES



index —

colour map —

collections —

linea collections —

cosmos

endless

evolution

prestige

pure stone

slabstone

subway

time 2.0

tool

useful information —

linea pure stone

— collection

linea pure stone

collection —

index

—

colour map

—

collections

—

linea collections

—

cosmos

endless

evolution

prestige

pure stone

—

slabstone

subway

time 2.0

tool

useful information

—

290

general catalogue . 2026

291

general catalogue . 2026

white LPS1 100x300 NR . 100x100 NR



linea pure stone

— collection



292

general catalogue . 2026

MARGRES
CERAMIC TILES

linea pure stone

collection —



293

general catalogue . 2026

light grey LPS3 100x300 NR . 100x100 NR

index



colour map



collections



linea collections



cosmos

endless

evolution

prestige

pure stone



slabstone

subway

time 2.0

tool

useful information



linea pure stone

— collection

white LPS1

NR



100x100	6mm	NR	R9	-	M3-6230
100x250	6mm	NR	R9	-	M3-7300
100x300	6mm	NR	R9	-	M3-7730

beige LPS2

NR



100x100	6mm	NR	R9	-	M3-6230
100x250	6mm	NR	R9	-	M3-7300
100x300	6mm	NR	R9	-	M3-7730

light grey LPS3

NR



100x100	6mm	NR	R9	-	M3-6230
100x250	6mm	NR	R9	-	M3-7300
100x300	6mm	NR	R9	-	M3-7730

linea pure stone

collection —

grey LPS4

NR

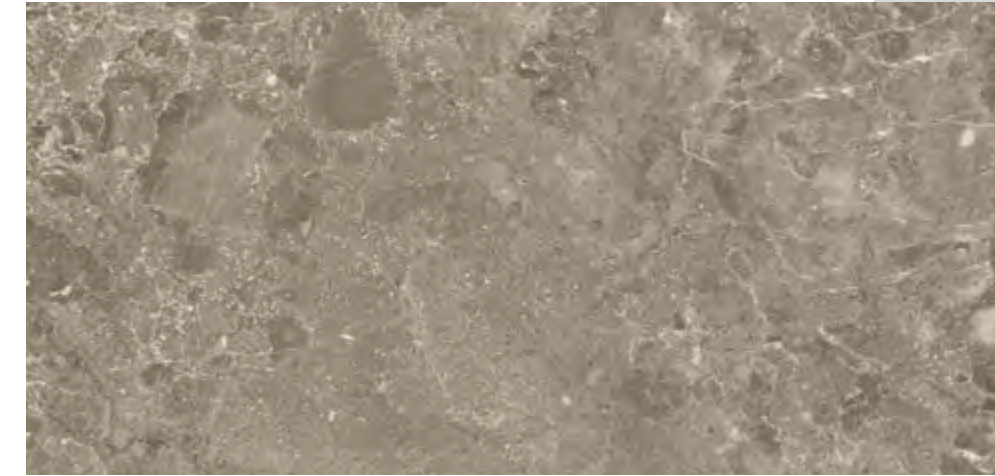

100x100	6mm	NR	R9	-	M3-6230
100x250	6mm	NR	R9	-	M3-7300
100x300	6mm	NR	R9	-	M3-7730

forge white LPS1F

NR



100x100	6mm	NR	R10	-	M3-6230
100x250	6mm	NR	R10	-	M3-7300
100x300	6mm	NR	R10	-	M3-7730

forge light grey LPS3F

NR



100x100	6mm	NR	R10	-	M3-6230
100x250	6mm	NR	R10	-	M3-7300
100x300	6mm	NR	R10	-	M3-7730

index

colour map

collections

linea collections

cosmos

endless

evolution

prestige

pure stone

slabstone

subway

time 2.0

tool

useful information

PROTECT

Antibacterial for Life.

An exclusive line of extremely high performance antimicrobial floor and wall tiles, designed for healthy, safe and protected living spaces.
 Une ligne exclusive de sols et revêtements antibactériens aux performances très élevées, pour un habitat sain, sûr et protégé.
 Eine exklusive Linie an hochwertigen Fußböden und antibakteriellen Wandverkleidungen, für ein gesundes, sicheres und geschütztes Leben.
 Uma linha exclusiva de pavimentos e revestimentos antimicrobianos de altíssima performance, projetada para ambientes saudáveis, seguros e protegidos.

MARGRES
 CERAMIC TILES





iron LCM2 100x300 NR . 100x100 NR

LAMINATED
PORCELAIN
STONEWARE

linea cosmos

collection —

- 
 DOWNLOAD
CATALOGUE
LINEA
- 
 DOWNLOAD
TECHNICAL
FEATURES
- 
 VIEW
ONLINE



100x300
NR 3,5mm

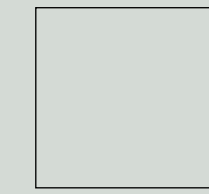

100x100
NR 3,5mm

rectified products . produits rectifiés . rektifizierete produkte . produtos retificados

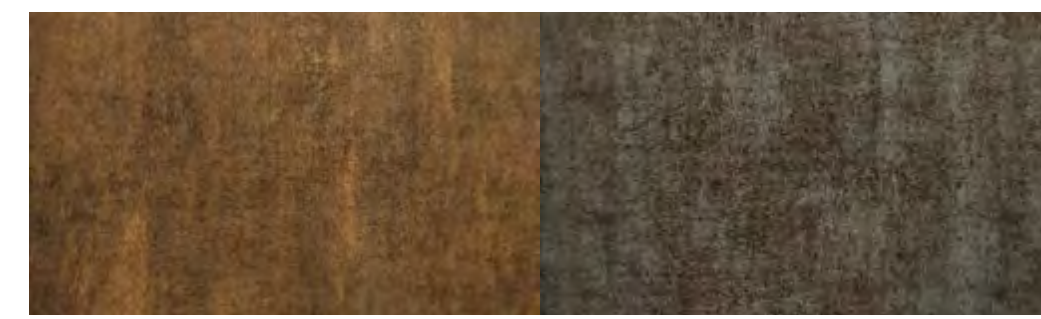

corten
LCM1

iron
LCM2

UGL V2 R10 

PR()TECT®
Antibacterial for Life.

MARGRES
CERAMIC TILES

- index —
- colour map —
- collections —

linea collections

- cosmos** —
- endless
- evolution
- prestige
- pure stone
- slabstone
- subway
- time 2.0
- tool

useful information



linea cosmos

— collection



298

general catalogue . 2026

corten LCM1 100x300 NR . 100x100 NR

linea cosmos

collection —

100x100	3,5mm	NR	R10	-	M3-1230
100x300	3,5mm	NR	R10	-	M3-1530

100x100	3,5mm	NR	R10	-	M3-1230
100x300	3,5mm	NR	R10	-	M3-1530

NR



corten LCM1

NR



iron LCM2

299

general catalogue . 2026

PROTECT®

Antibacterial for Life.

An exclusive line of extremely high performance antimicrobial floor and wall tiles, designed for healthy, safe and protected living spaces.
Une ligne exclusive de sols et revêtements antibactériens aux performances très élevées, pour un habitat sain, sûr et protégé.
Eine exklusive Linie an hochwertigen Fußböden und antibakteriellen Wandverkleidungen, für ein gesundes, sicheres und geschütztes Leben.
Uma linha exclusiva de pavimentos e revestimentos antimicrobianos de altíssima performance, projetada para ambientes saudáveis, seguros e protegidos.

index

colour map

collections

linea collections

cosmos

endless

evolution

prestige

pure stone

slabstone

subway

time 2.0

tool

useful information





300

general catalogue . 2026

tortora LTL3 120x260 NR . 120x120 NR

LAMINATED
PORCELAIN
STONEWARE

linea tool

collection —
P. 211

↓
DOWNLOAD
CATALOGUE

↓
DOWNLOAD
TECHNICAL
FEATURES

🌐
VIEW
ONLINE

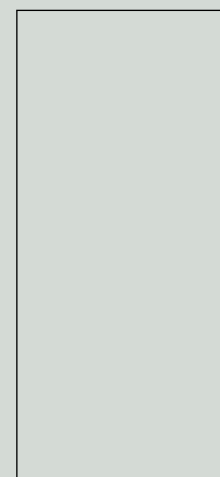

120x260
NR 6mm

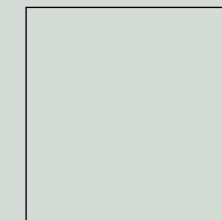

120x120
NR 6mm



60x120
NR 6mm

rectified products . produits rectifiés . rektifizierte produkte . produtos retificados



white
LTL1

light grey
LTL2

tortora
LTL3

grey
LTL4

UGL V3 R9

PR()TECT®

Antibacterial for Life.

MARGRES
CERAMIC TILES



index

colour map

collections

linea collections

cosmos

endless

evolution

prestige

pure stone

slabstone

subway

time 2.0

tool

useful information

301

general catalogue . 2026

linea tool

collection

linea tool

collection

index

colour map

collections

linea collections

cosmos

endless

evolution

prestige

pure stone

slabstone

subway

time 2.0

tool

useful information



grey LTL4 120x120 NR

302

general catalogue .2026

303

general catalogue .2026

linea tool

— collection

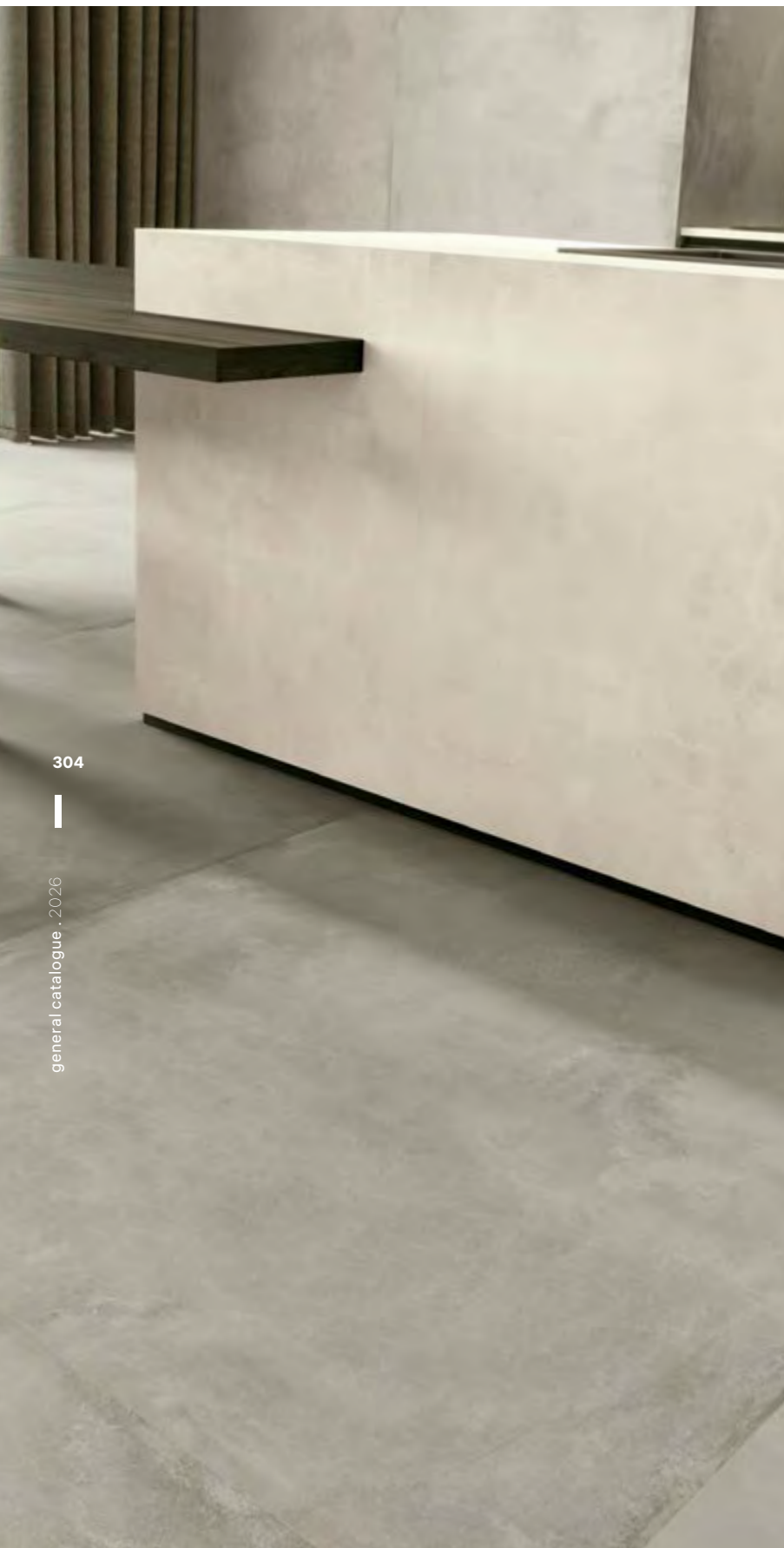

304

general catalogue . 2026

linea tool

collection —



305

general catalogue . 2026

light grey LTL2 120x260 NR . 120x120 NR . white LTL1 NR

index



colour map



collections



linea collections



cosmos

endless

evolution

prestige

pure stone

slabstone

subway

time 2.0

tool



useful information



linea tool

— collection

white LTL1

NR

60x120	6mm	NR	R9	-	M3-5730
120x120	6mm	NR	R9	-	M3-6730
120x260	6mm	NR	R9	-	M3-8230

tortora LTL3

NR

60x120	6mm	NR	R9	-	M3-5730
120x120	6mm	NR	R9	-	M3-6730
120x260	6mm	NR	R9	-	M3-8230

linea tool

collection —

light grey LTL2

NR

60x120	6mm	NR	R9	-	M3-5730
120x120	6mm	NR	R9	-	M3-6730
120x260	6mm	NR	R9	-	M3-8230

NR

grey LTL4

60x120	6mm	NR	R9	-	M3-5730
120x120	6mm	NR	R9	-	M3-6730
120x260	6mm	NR	R9	-	M3-8230

306

307

general catalogue . 2026

general catalogue . 2026

index

colour map

collections

linea collections

cosmos

endless

evolution

prestige

pure stone

slabstone

subway

time 2.0

tool

useful information

MARGRES
CERAMIC TILES

PROTECT

Antibacterial for Life.

An exclusive line of extremely high performance antimicrobial floor and wall tiles, designed for healthy, safe and protected living spaces.
Une ligne exclusive de sols et revêtements antibactériens aux performances très élevées, pour un habitat sain, sûr et protégé.
Eine exklusive Linie an hochwertigen Fußböden und antibakteriellen Wandverkleidungen, für ein gesundes, sicheres und geschütztes Leben.
Uma linha exclusiva de pavimentos e revestimentos antimicrobianos de altíssima performance, projetada para ambientes saudáveis, seguros e protegidos.





308

general catalogue . 2026

calacatta LPT1 100x300 P . 100x100 P

LAMINATED
PORCELAIN
STONEWARE

linea prestige

collection —
P. 179

↓
DOWNLOAD
CATALOGUE

↓
DOWNLOAD
TECHNICAL
FEATURES

🌐
VIEW
ONLINE



100x300
NR . P 5,5mm



100x250
NR . P 5,5mm

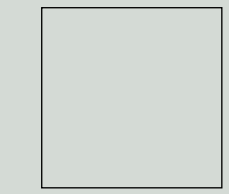

100x100
NR . P . ASR 5,5mm

rectified products . produits rectifiés . rektifizierete produkte . produtos retificados



calacatta
LPT1

UGL **V2** **R10**
ASR NR ASR

PR()TECT®
Antibacterial for Life.

MARGRES
CERAMIC TILES

309

general catalogue . 2026

index —

colour map —

collections —

linea collections —

cosmos

endless

evolution

prestige

pure stone

slabstone

subway

time 2.0

tool

useful information —



linea prestige

— collection



310

general catalogue . 2026

calacatta LPT1 100x300 P . 100x100 ASR

linea prestige

collection —

100x100	5,5mm	ASR	R10	-	M3-2730
	5,5mm	NR	-	-	M3-2730
	5,5mm	P	-	-	M3-3130
100x250	5,5mm	NR	-	-	M3-3530
	5,5mm	P	-	-	M3-3830
100x300	5,5mm	NR	-	-	M3-4230
	5,5mm	P	-	-	M3-4630

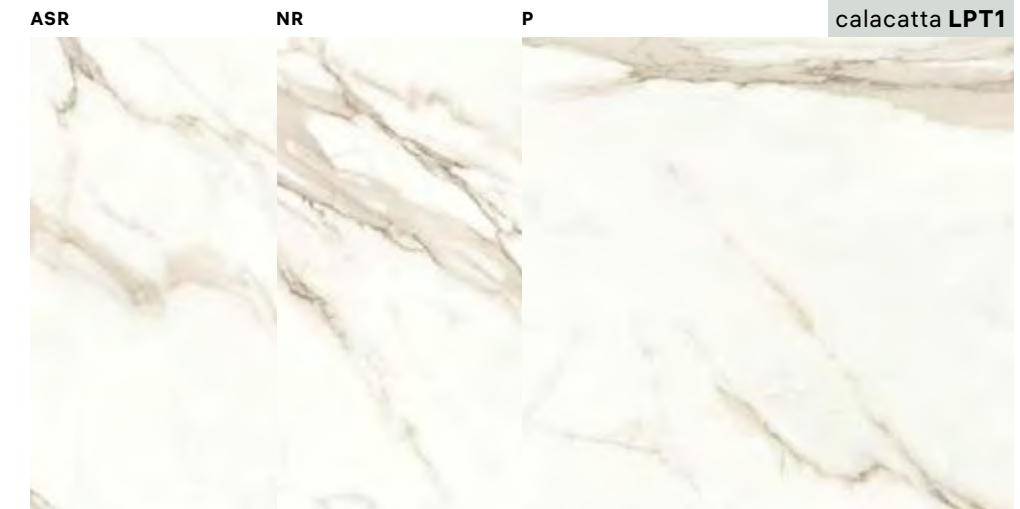

311

general catalogue . 2026

Products with a polished finish are more sensitive to abrasion and stains, what requires special conditions. Please see page 358 in chapter 09.
Les produits à finition polie sont plus sensibles à l'abrasion et aux taches, ce qui requiert des conditions particulières. Veuillez-vous consulter la page 358 du chapitre 09.
Produkte mit einer polierten Oberfläche sind empfindlicher gegen Abrieb und Fleckenbildung, was besondere Bedingungen erfordert. Bitte beachten Sie Seite 358 in Kapitel 09.
Os produtos com acabamento polido são mais sensíveis à abrasão e às manchas, o que requer condições especiais. Por favor consulte a página 358 no capítulo 09.

PROTECT

Antibacterial for Life.

An exclusive line of extremely high performance antimicrobial floor and wall tiles, designed for healthy, safe and protected living spaces. Anti-slip finish doesn't have antibacterial protection.
Une ligne exclusive de sols et revêtements antibactériens aux performances très élevées, pour un habitat sain, sûr et protégé. La finition antidérapante n'a pas de protection antibactérienne.
Eine exklusive Linie an hochwertigen Fußböden und antibakteriellen Wandverkleidungen, für ein gesundes, sicheres und geschütztes Leben. Die rutschfeste Oberfläche hat keinen antibakteriellen Schutz.
Uma linha exclusiva de pavimentos e revestimentos antimicrobianos de altíssima performance, projetada para ambientes saudáveis, seguros e protegidos. O acabamento antiderrapante não tem proteção antibacteriana.

index

colour map

collections

linea collections

cosmos

endless

evolution

prestige

pure stone

slabstone

subway

time 2.0

tool

useful information





beige LSL2 100x300 NR . 100x100 NR

LAMINATED
PORCELAIN
STONEWARE

linea slabstone

collection —
P. 223

- ↓
DOWNLOAD
BIM
- ↓
DOWNLOAD
CATALOGUE
- ↓
DOWNLOAD
TECHNICAL
FEATURES
- 🌐
VIEW
ONLINE



100x300
NR 3,5mm

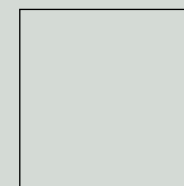

100x100
NR 3,5mm

rectified products . produits rectifiés . rektifizierte produkte . produtos retificados

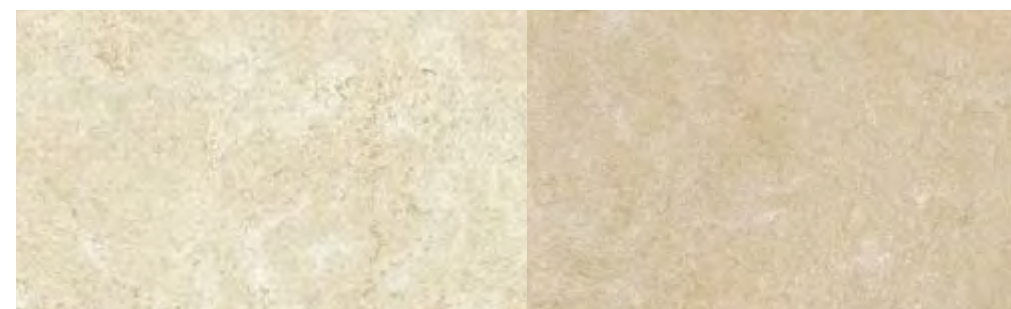

white
LSL1

beige
LSL2

UGL **V2** **R9**

BIM

PR()TECT®

Antibacterial for Life.

MARGRES
CERAMIC TILES



index —

colour map —

collections —

linea collections —

cosmos

endless

evolution

prestige

pure stone

slabstone —

subway

time 2.0

tool

useful information —

linea slabstone

— collection



314

general catalogue . 2026

white LSL1 100x300 NR

linea slabstone

collection —

100x100	3,5mm	NR	R9	-	M3-1230
100x300	3,5mm	NR	R9	-	M3-1530

100x100	3,5mm	NR	R9	-	M3-1230
100x300	3,5mm	NR	R9	-	M3-1530

NR



white LSL1

NR



beige LSL2

315

general catalogue . 2026

index

colour map

collections

linea collections

cosmos

endless

evolution

prestige

pure stone

slabstone

subway

time 2.0

tool

useful information

PR () TECT

Antibacterial for Life.

An exclusive line of extremely high performance antimicrobial floor and wall tiles, designed for healthy, safe and protected living spaces.
Une ligne exclusive de sols et revêtements antibactériens aux performances très élevées, pour un habitat sain, sûr et protégé.
Eine exklusive Linie an hochwertigen Fußböden und antibakteriellen Wandverkleidungen, für ein gesundes, sicheres und geschütztes Leben.
Uma linha exclusiva de pavimentos e revestimentos antimicrobianos de altíssima performance, projetada para ambientes saudáveis, seguros e protegidos.



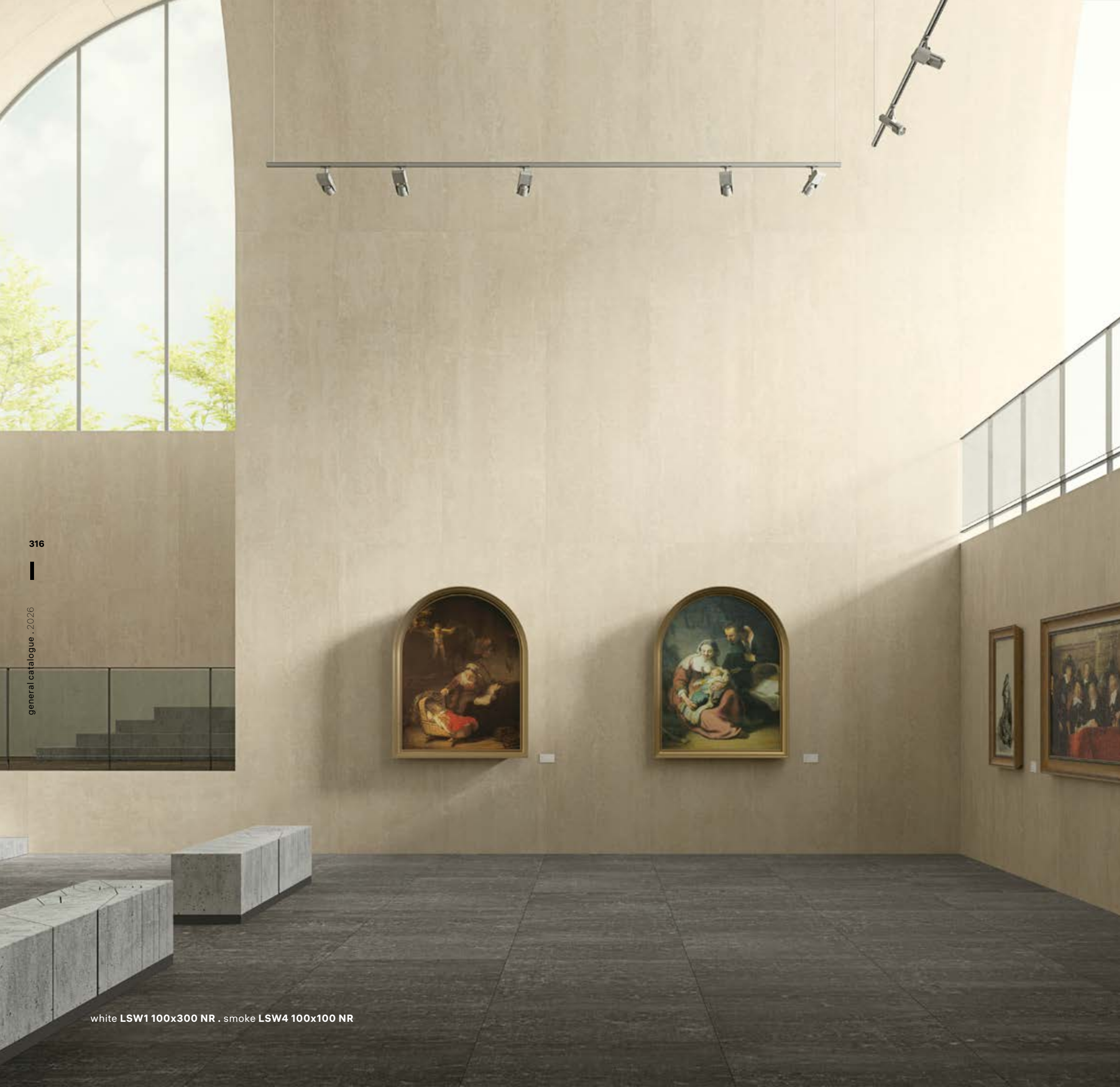

white LSW1 100x300 NR . smoke LSW4 100x100 NR

LAMINATED
PORCELAIN
STONEWARE

linea subway

collection —
P. 233

- 
 ENJOY THE VIDEO
- 
 DOWNLOAD CATALOGUE
- 
 DOWNLOAD TECHNICAL FEATURES
- 
 VIEW ONLINE



100x300
NR 3,5mm

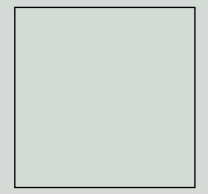

100x100
NR 3,5mm

rectified products . produits rectifiés . rektifizierte produkte . produtos retificados



white LSW1 ash LSW2 clay LSW3 smoke LSW4

UGL V2 R9 

PR()TECT®
Antibacterial for Life.

MARGRES
CERAMIC TILES



index —

colour map —

collections —

linea collections —

- cosmos
- endless
- evolution
- prestige
- pure stone
- slabstone

subway

- time 2.0
- tool

useful information —

linea subway

— collection



318

general catalogue . 2026



linea subway

collection —



319

general catalogue . 2026

ash LSW2 100x300 . 100x100 NR

index

colour map

collections

linea collections

cosmos

endless

evolution

prestige

pure stone

slabstone

subway

time 2.0

tool

useful information



linea subway

— collection

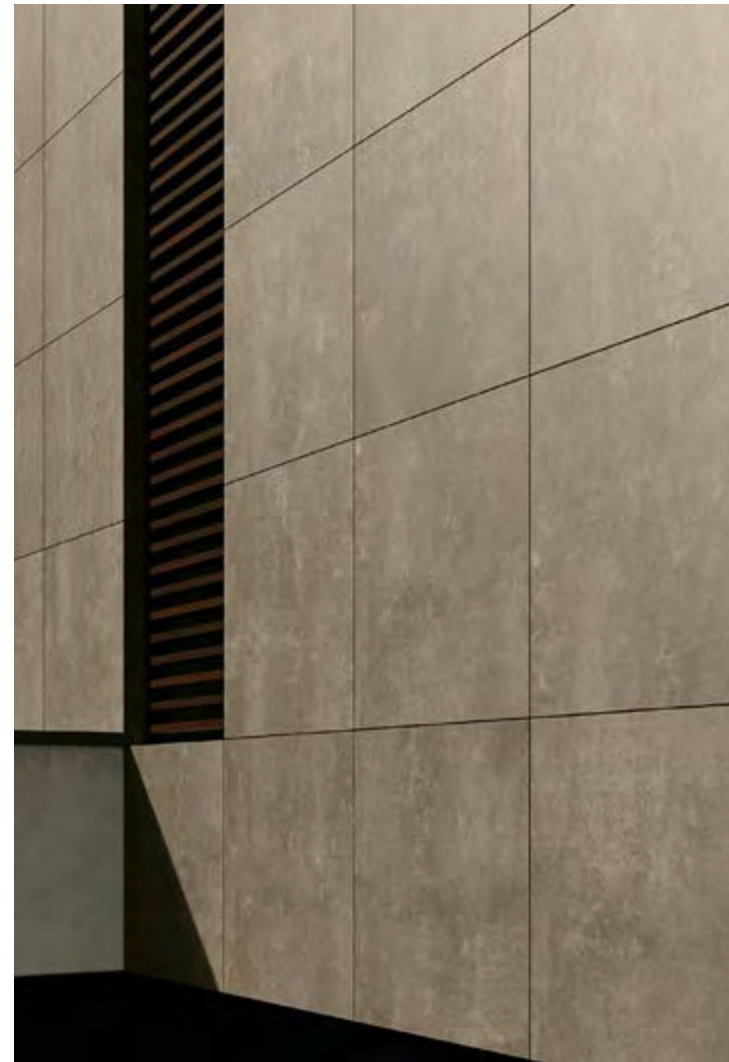

320

general catalogue . 2026



linea subway

collection —



321

general catalogue . 2026

clay LSW3 100x300 . 100x100 NR

index



colour map



collections



linea collections



cosmos

endless

evolution

prestige

pure stone

slabstone

subway

time 2.0

tool

useful information



linea subway

collection

white LSW1

NR



100x100	3,5mm	NR	R9	-	M3-1230
100x300	3,5mm	NR	R9	-	M3-1530

clay LSW3

NR



100x100	3,5mm	NR	R9	-	M3-1230
100x300	3,5mm	NR	R9	-	M3-1530

linea subway

collection

NR



ash LSW2

100x100	3,5mm	NR	R9	-	M3-1230
100x300	3,5mm	NR	R9	-	M3-1530

NR



smoke LSW4

100x100	3,5mm	NR	R9	-	M3-1230
100x300	3,5mm	NR	R9	-	M3-1530

322

323

general catalogue . 2026

general catalogue . 2026

index

colour map

collections

linea collections

cosmos

endless

evolution

prestige

pure stone

slabstone

subway

time 2.0

tool

useful information

MARGRES
CERAMIC TILES

PROTECT
Antibacterial for Life.

An exclusive line of extremely high performance antimicrobial floor and wall tiles, designed for healthy, safe and protected living spaces.
Une ligne exclusive de sols et revêtements antibactériens aux performances très élevées, pour un habitat sain, sûr et protégé.
Eine exklusive Linie an hochwertigen Fußböden und antibakteriellen Wandverkleidungen, für ein gesundes, sicheres und geschütztes Leben.
Uma linha exclusiva de pavimentos e revestimentos antimicrobianos de altíssima performance, projetada para ambientes saudáveis, seguros e protegidos.





324

general catalogue . 2026

silver LT26 100x100 NR

LAMINATED
PORCELAIN
STONEWARE

linea time 2.0

collection —
P. 241

- ↓
DOWNLOAD
BIM
- ↓
DOWNLOAD
CATALOGUE
- ↓
DOWNLOAD
TECHNICAL
FEATURES
- 🌐
VIEW
ONLINE



100x300
NR 3,5mm

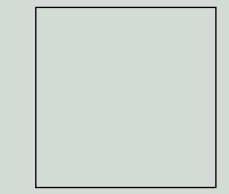

100x100
NR 3,5mm

rectified products . produits rectifiés . rektifizierte produkte . produtos retificados

325

general catalogue . 2026

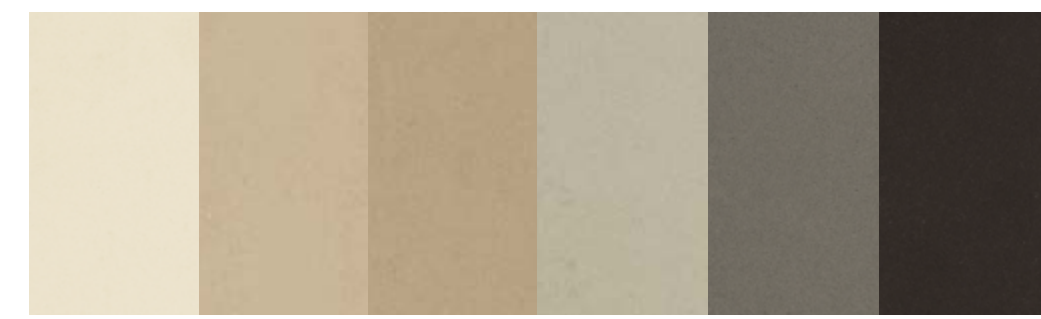

snow LT21 cream LT23 beige LT24 silver LT26 carbon LT28 black LT29

UGL **V1** **R9**

BIM

PR()TECT®
Antibacterial for Life.

MARGRES
CERAMIC TILES



index —

colour map —

collections —

linea collections —

- cosmos
- endless
- evolution
- prestige
- pure stone
- slabstone
- subway
- time 2.0**
- tool

useful information —

linea time 2.0

— collection

linea time 2.0

collection —

index

—

colour map

—

collections

—

linea collections

—

cosmos

endless

evolution

prestige

pure stone

slabstone

subway

time 2.0

—
tool

useful information

—



326

general catalogue . 2026

327

general catalogue . 2026

black LT29 100x100 NR



linea time 2.0

— collection

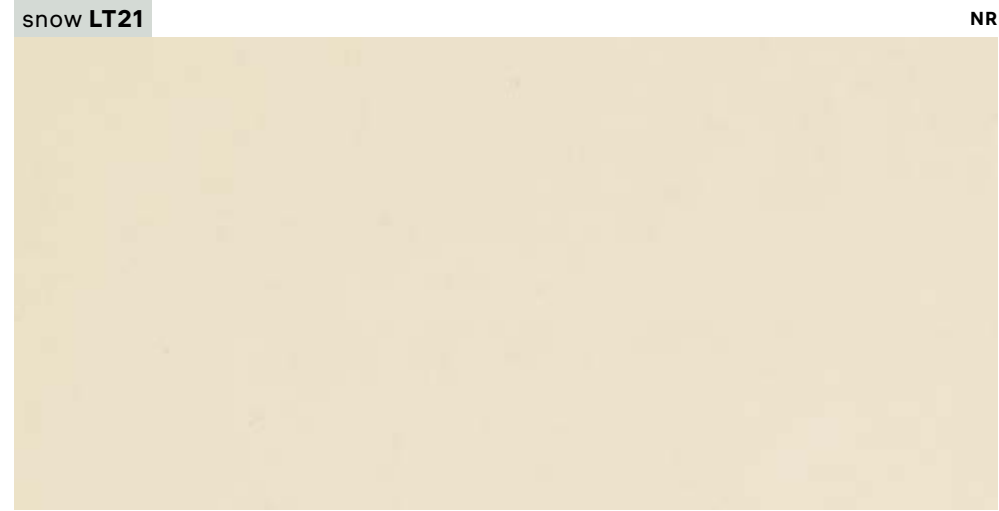

100x100	3,5mm	NR	R9	-	M3-1230
100x300	3,5mm	NR	R9	-	M3-1530



100x100	3,5mm	NR	R9	-	M3-1230
100x300	3,5mm	NR	R9	-	M3-1530

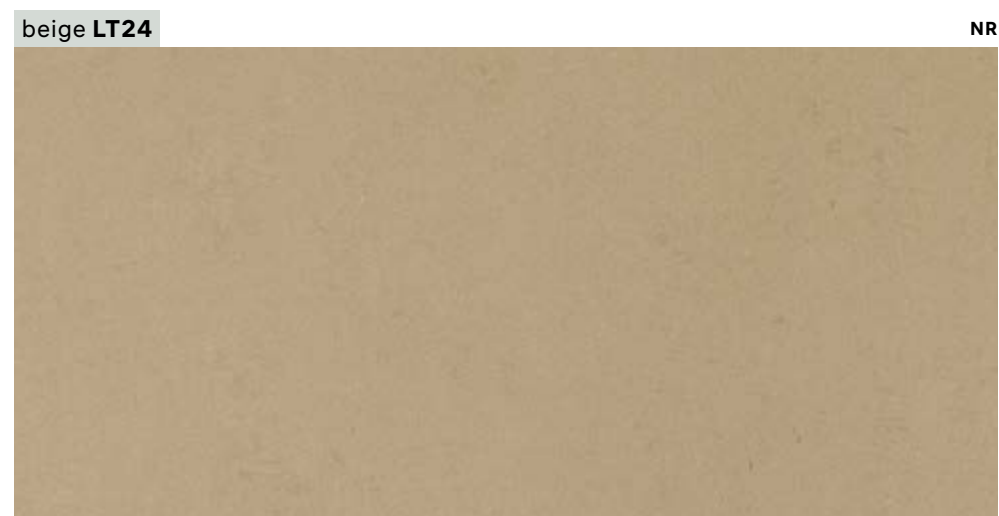

100x100	3,5mm	NR	R9	-	M3-1230
100x300	3,5mm	NR	R9	-	M3-1530

linea time 2.0

collection —



100x100	3,5mm	NR	R9	-	M3-1230
100x300	3,5mm	NR	R9	-	M3-1530

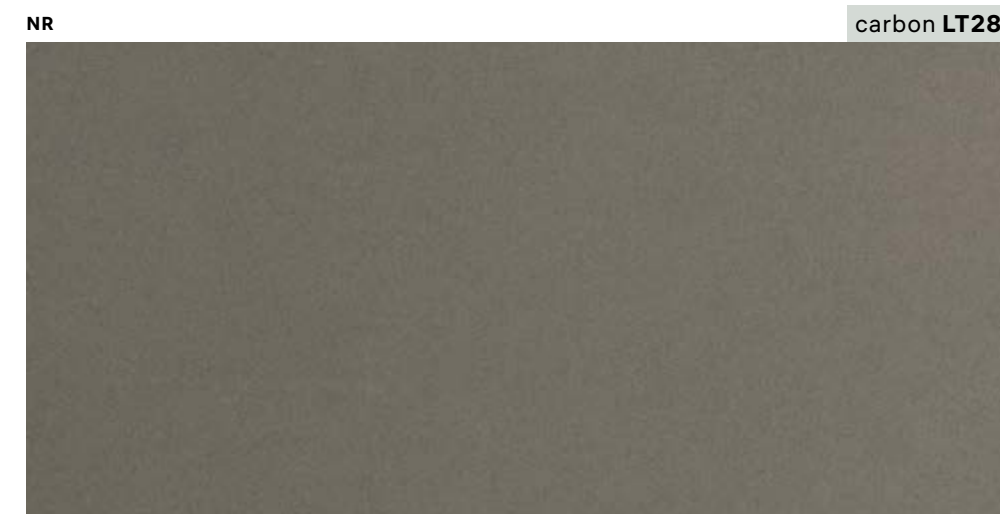

100x100	3,5mm	NR	R9	-	M3-1230
100x300	3,5mm	NR	R9	-	M3-1530

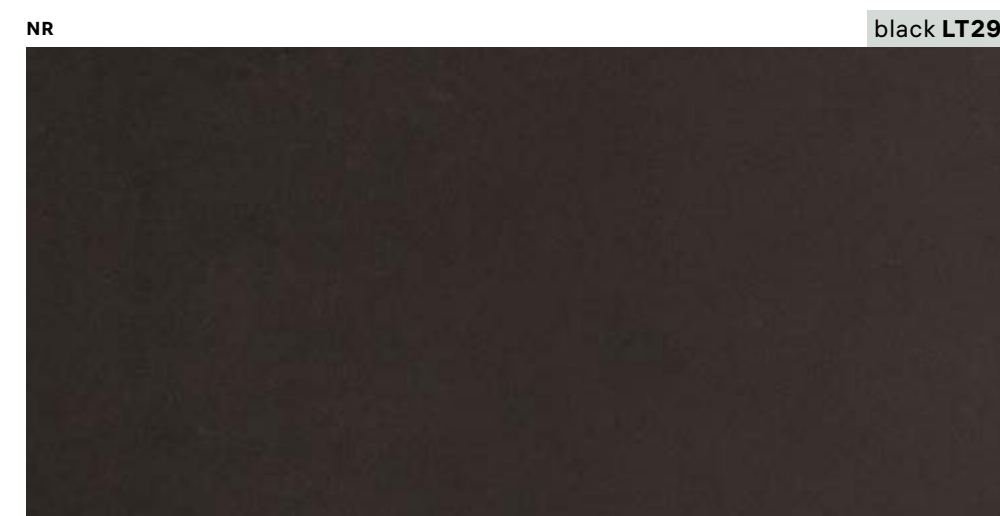

100x100	3,5mm	NR	R9	-	M3-1230
100x300	3,5mm	NR	R9	-	M3-1530

index

colour map

collections

linea collections

cosmos

endless

evolution

prestige

pure stone

slabstone

subway

time 2.0

tool

useful information

328

329

general catalogue . 2026

general catalogue . 2026

MARGRES
CERAMIC TILES

PR()TECT®
Antibacterial for Life.

An exclusive line of extremely high performance antimicrobial floor and wall tiles, designed for healthy, safe and protected living spaces.
Une ligne exclusive de sols et revêtements antibactériens aux performances très élevées, pour un habitat sain, sûr et protégé.
Eine exklusive Linie an hochwertigen Fußböden und antibakteriellen Wandverkleidungen, für ein gesundes, sicheres und geschütztes Leben.
Uma linha exclusiva de pavimentos e revestimentos antimicrobianos de altíssima performance, projetada para ambientes saudáveis, seguros e protegidos.



useful information

informations utiles . technische information . informações úteis —

calibers calibres kaliber calibres	P. 365
certification certification zertifizierung certificação	P. 340
general sales conditions conditions générales de vente allgemeine verkaufsbedingungen condições gerais de venda	P. 368
important notes notes importantes wichtige hinweise notas importantes	P. 375
laying suggestions suggestions de pose anwendungsvorschläge sugestões de aplicação	P. 367
margres tools	P. 332
outdoor extra thick	P. 348
package emballage verpackung embalagem	P. 364
pr()tect	P. 334
sustainable choice	P. 336
symbols symbologie zeichen simbologia	P. 366
technical information information technique technische information informação técnica	P. 352

331

general catalogue . 2026

index —

colour map —

collections —

linea collections —

useful information —

calibers

certification

general sales

conditions

important notes

laying suggestions

margres green

margres tools

outdoor extra thick

package

Protect

sustainable choice

symbols

technical information

MARGRES
CERAMIC TILES



3D tool

spark your imagination

With our **3D Tool**, create environments from scratch through the modelling space, customise objects, request quotations and save all your creations.

Start creating now.

lassen sie ihrer fantasie freien lauf

Mit unserem **3D Tool** können Sie von Grund auf neue Räume im Modellierungsbereich gestalten und erstellen, Objekte individuell personalisieren, Kostenvoranschläge anfordern und alle Ihre Kreationen speichern.

Beginnen Sie jetzt mit dem Gestalten.

laissez libre cours à votre imagination

Avec notre **3D Tool**, vous pouvez créer de nouveaux environnements à partir de zéro grâce à l'espace de modélisation, personnaliser des objets, demander des devis et sauvegarder toutes vos créations.

Commencez à créer dès maintenant.

dê largas à sua imaginação

Com o nosso **3D Tool** crie ambientes de raiz através do espaço de modelação, personalize objetos, peça orçamentos e guarde todas as suas criações.

Comece a criar agora.



turn your dreams into reality

Go to www.margres.com, access **Margres AR**, take a picture with your mobile phone and test the application of our floors, in real time and with the full-scale simulation of our products.

Enter our application and simulate the floor of your house!

vereinen sie traum und realität

Besuchen Sie www.margres.com, öffnen Sie **Margres AR**, machen Sie ein Foto mit Ihrem Smartphone und testen Sie die Anwendung unserer Bodenbeläge in Echtzeit und mit einer realitätsgetreuen Simulation unserer Produkte in Originalgröße.

Starten Sie unsere App und simulieren Sie diesen Bodenbelag direkt in Ihrem Zuhause!

margres AR



unissez le rêve à la réalité

Rendez-vous sur www.margres.com, accédez à **Margres AR**, prenez une photo avec votre téléphone portable et testez l'application de nos revêtements de sol en temps réel, avec une simulation de nos produits à l'échelle réelle.

Entrez dans notre application et simulez ce revêtement de sol dans votre maison!

una o sonho à realidade

Vá a www.margres.com, aceda a **Margres AR**, tire uma foto com o seu telemóvel e teste a aplicação dos nossos pavimentos, em tempo real e com a simulação dos nossos produtos à escala real.

Entre na nossa aplicação e simule este piso na sua casa!

[index](#)

[colour map](#)

[collections](#)

[linea collections](#)

[useful information](#)

[calibers](#)

[certification](#)

[general sales](#)

[conditions](#)

[important notes](#)

[laying suggestions](#)

[margres green](#)

[margres tools](#)

[outdoor extra thick](#)

[package](#)

[Protect](#)

[sustainable choice](#)

[symbols](#)

[technical information](#)



PROTECT®

Antibacterial for Life.

An exclusive line of extremely high performance antimicrobial floor and wall tiles, designed for healthy, safe and protected living spaces. Anti-slip finish doesn't have antibacterial protection.

Une ligne exclusive de sols et revêtements antibactériens aux performances très élevées, pour un habitat sain, sûr et protégé. La finition antidérapante n'a pas de protection antibactérienne.

Eine exklusive Linie an hochwertigen Fußböden und antibakteriellen Wandverkleidungen, für ein gesundes, sicheres und geschütztes Leben. Die rutschfeste Oberfläche hat keinen antibakteriellen Schutz.

Uma linha exclusiva de pavimentos e revestimentos antimicrobianos de altíssima performance, projetada para ambientes saudáveis, seguros e protegidos. O acabamento antiderrapante não tem proteção antibacteriana.



powerful action

eliminates up to 99.9% of bacteria and prevents their reproduction

action puissante

élimine jusqu'à 99,9% des bactéries et empêche leur prolifération

leistungsstarke wirkung

eliminiert bis zu 99,9% Bakterien und ihre Verbreitung verhindern.

ação potente

elimina até 99,9% das bactérias e impede a sua reprodução



continuous protection

always active, 24 hours a day, with or without sunlight

protection continue

toujours actif, 24 heures sur 24 avec ou sans lumière naturelle

dauerschutz

immer aktiv, Rund um die Uhr, mit oder ohne Sonnenlicht

proteção contínua

permanente ativo, 24 horas por dia, com ou sem luz solar



eternal effectiveness

thanks to technology integrated into the product

efficacité permanente

grâce à la technologie intégrée dans le produit

dauerhafte wirksamkeit

dank der im Produkt integrierten Technologie

eficácia permanente

graças à tecnologia incorporada no produto



guaranteed quality

by the partnership with Microban®

qualité garantie

en partenariat avec Microban®

garantierte qualität

dank der Partnership mit Microban®

qualidade garantida

em parceria com a Microban®



der sicherste ort der welt

die aktive antibakterielle aktion geht weiter

- Wir haben uns für Microban®, den Weltmarktführer in antibakterieller Technologie entschieden, um unsere Fliesen noch sicherer zu machen.
- In der Fläche einer Hand leben mehr Bakterien als Menschen auf der Erde.
- Bakterielles Wachstum kann sich auf ungeschützten Oberflächen alle 20 Minuten verdoppeln.

Fußböden in Bereichen mit hohem Fußgängeraufkommen wie Schulen, Büros, Krankenhäusern und öffentlichen Gebäuden sind ideale Orte für mikrobisches und bakterielles Wachstum, und sogar unsere Wohnungen können trotz täglicher Reinigung durch Erreger und Bakterien von außen verseucht sein. Margres-Produkte bieten immer höchste Qualität in Verbindung mit unerreichter Schönheit und bahnbrechenden Lösungen.

Heute geben wir, dank der andauernden Forschungsarbeit des Panariagroup Research Centre und einem Übereinkommen mit Microban®, dem Weltmarktführer in antibakterieller Technologie bekannt, dass die anhand der Microban® -Technologie gefertigten Margres-Fliesen mehr als nur Schönheit und Strapazierfähigkeit verkörpern: Gesundheit und biologische Sicherheit für unsere Wohn-, Freizeit- und Arbeitsbereiche.

Dank der silberbasierten Technologie sind unsere Fliesen durch eine innovative antibakterielle Barriere geschützt, die bis zu 99,9% der Bakterien an der Oberfläche eliminiert und einen dauerhaften Schutz gegen Abnutzung, Witterung und wiederholte Reinigung in jeglichem Einsatzumfeld bietet.

Die Microban Silbertechnologie wurde gemäß der Anforderungen der EU-Richtlinie für Biozid-Produkte (98/8/CE) unter dem Schutz der Richtlinie für Biozid-Produkte (BPD, Biocidal Product Directive) registriert.

Außerdem ist die Microban®-Technologie 24 Stunden am Tag aktiv und garantiert auf diese Weise Tag- und Nachtschutz, indem sie die Fliesen zwischen den Putzvorgängen hygienisch hält.

MARGRES
CERAMIC TILES

PROTECT®

Antibacterial for Life.

o local mais seguro do mundo

ação antibacteriana ativa contínua

- Escolhemos o Microban®, o líder global em tecnologia antibacteriana, para tornar os nossos mosaicos ainda mais seguros.
- Há mais bactérias numa mão do que pessoas na Terra.
- O crescimento bacteriano pode duplicar de número a cada 20 minutos, em superfícies não protegidas.

Os pavimentos das áreas com elevados níveis de tráfego pedestre, tais como escolas, escritórios, hospitais e edifícios públicos são locais ideais para o crescimento microbiano e bacteriano, mas as nossas casas, apesar da limpeza diária, também podem ser contaminadas por germes e bactérias do exterior. A Margres oferece sempre produtos de mais elevada qualidade, aliados a uma beleza inigualável e soluções de vanguarda.

Atualmente, graças ao trabalho contínuo no Panariagroup Research Centre de um acordo prestigioso com a Microban®, o líder global em tecnologia antibacteriana, temos o orgulho de anunciar que os mosaicos Margres, produzidos com a tecnologia Microban®, são concebidos tendo em mente algo mais do que a beleza e durabilidade: ainda mais saúde e segurança biológica para os nossos ambientes domésticos, de lazer e trabalho.

Grças à tecnologia incorporada com base de prata, os nossos mosaicos estão protegidos por uma barreira antibacteriana inovadora que elimina até 99,9% das bactérias na superfície e garante uma proteção duradoura contra o desgaste, condições climáticas e limpezas repetidas em qualquer ambiente de utilização.

A tecnologia de prata Microban foi registada junto da Diretiva de Produtos Biocidas (BPD, Biocidal Product Directive), sob os tipos de produto adequados conforme requerido pela Diretiva de Produtos Biocidas da UE, 98/8/CE.

Além disso, a tecnologia Microban® está ativa 24 horas por dia, garantindo proteção contínua dia e noite, mantendo os mosaicos mais higiénicos entre as limpezas.

index

colour map

collections

linea collections

useful information

calibers

certification

general sales

conditions

important notes

laying suggestions

margres green

margres tools

outdoor extra thick

package

Protect

sustainable choice

symbols

technical information



a sustainable choice

— un choix durable . eine nachhaltige entscheidung . uma escolha sustentável

this is our manifesto towards carbon neutrality.

Sustainability is not a distant goal. It's a daily choice that guides everything we do across our brands.

While technology has not yet made it possible to be 100% green, we choose to act now. We are transforming our products and aligning our industry with carbon neutrality, biodiversity and sustainability, redesigning and rethinking every product and service to make them truly sustainable.

Caring for our planet is not just what we do — it's who we are.
We choose to be sustainable. Today. Tomorrow. Always.

dies ist unser manifest für CO₂-neutralität.

Nachhaltigkeit ist kein fernes Ziel. Es ist eine tägliche Entscheidung, die alles bestimmt, was wir mit unseren Marken tun.

Auch wenn es die Technologien noch nicht ermöglicht, zu 100% umweltfreundlich zu sein, haben wir uns entschieden, jetzt zu handeln. Wir transformieren unsere Produkte und richten unsere Branche auf CO₂-Neutralität, Biodiversität und Nachhaltigkeit aus. Wir überarbeiten und überdenken jedes Produkt und jede Dienstleistung, um sie wirklich nachhaltig zu gestalten.

Die Sorge um unseren Planeten ist nicht nur das, was wir tun – sie ist das, was wir sind.

Wir entscheiden uns für Nachhaltigkeit. Heute. Morgen. Immer.



2,740*

tons of CO₂ - emissions cutting
tonnes de CO₂ - émissions en moins
tonnen CO₂ - einsparungen
toneladas de CO₂ - redução de emissões



100%*

of water and raw materials back into production
de l'eau et des matières premières réutilisées dans la production
des wassers und der rohstoffe werden wieder in die produktion zurückgeführt
da água e das matérias-primas reutilizadas na produção

voici notre manifeste en faveur de la neutralité carbone.

La durabilité n'est pas un objectif lointain. C'est un choix quotidien qui guide toutes nos actions au sein de nos marques.

Même si la technologie ne permet pas encore d'être 100 % écologique, nous avons choisi d'agir dès maintenant. Nous transformons nos produits et alignons notre industrie sur la neutralité carbone, la biodiversité et la durabilité, en repensant et en redéfinissant chaque produit et service afin de les rendre véritablement durables.

Prendre soin de notre planète n'est pas seulement ce que nous faisons, c'est ce que nous sommes.

Nous choisissons d'être durables. Aujourd'hui. Demain. Toujours.

este é o nosso manifesto em prol da neutralidade carbónica.

A sustentabilidade não é um objetivo distante. É uma escolha diária que orienta tudo o que fazemos nas nossas marcas.

Embora a tecnologia ainda não permita ser 100% ecológico, optamos por agir agora. Estamos a transformar os nossos produtos e a alinhar a nossa indústria com a neutralidade carbónica, a biodiversidade e a sustentabilidade, redesenhando e repensando todos os produtos e serviços para os tornar verdadeiramente sustentáveis.

Cuidar do nosso planeta não é apenas o que fazemos – é quem nós somos.

Optamos por ser sustentáveis. Hoje. Amanhã. Sempre.



3942,88 kWh*

solar energy in our industrial units
d'énergie solaire dans nos unités industrielles
solarenergie in unseren Industrieanlagen
de energia solar nas nossas unidades industriais



9.200 MWh*

of electricity all backed by guarantees of renewable origin
d'électricité d'électricité, tous garantis d'origine renouvelable
strom allesamt mit Garantien für erneuerbare Herkunft
de eletricidade todos com garantias de origem renovável

what does it mean to be sustainable?

to be accountable

Through our EDP certification, we measure the environmental impact of our ceramic surfaces across their entire life cycle.

to be reducing, recycling & reincorporating

We have reduced the thickness of our products, significantly lowering CO₂ emissions.

We reincorporate up to 100% of water, energy and raw materials back into production, ensuring a circular approach to resources.

to be compensating

We produce solar energy in our industrial units, reducing our dependence on non-renewable sources.

To further offset our CO₂ emissions, we invest in carbon credits, that are certificates purchased by companies to help offset the CO₂ emissions they produce.

to be innovating & certifying

Our ceramics are designed to ensure 100% toxin-free environments and are protected with Microban antibacterial technology.

They carry the **Protect** seal and trusted certifications, guaranteeing safety and performance.

was bedeutet es, nachhaltig zu sein?

verantwortung übernehmen

Durch unsere EDP-Zertifizierung messen wir die Umweltauswirkungen unserer Keramikoberflächen über ihren gesamten Lebenszyklus hinweg.

reduzieren, recyceln und wiederverwenden

Wir haben die Dicke unserer Produkte reduziert und damit die CO₂-Emissionen deutlich gesenkt.

Wir führen bis zu 100 % des Wassers, der Energie und der Rohstoffe wieder in die Produktion zurück und gewährleisten so einen kreislaufwirtschaftlichen Umgang mit Ressourcen.

kompensieren

Wir produzieren Solarenergie in unseren Industrieanlagen und reduzieren so unsere Abhängigkeit von nicht erneuerbaren Energiequellen.

Um unsere CO₂-Emissionen weiter auszugleichen, investieren wir in Emissionszertifikate, die von Unternehmen erworben werden, um ihre CO₂-Emissionen auszugleichen.

innovation und zertifizierung

Unsere Keramikprodukte sind so konzipiert, dass sie eine 100% giftfreie Umgebung gewährleisten, und sind mit der antibakteriellen Microban-Technologie geschützt.

Sie tragen das **Protect**-Siegel und vertrauenswürdige Zertifizierungen, die Sicherheit und Leistung garantieren.

a sustainable choice

— un choix durable . eine nachhaltige entscheidung . uma escolha sustentável

que signifie être durable?

être responsable

Grâce à notre certification EDP, nous mesurons l'impact environnemental de nos surfaces céramiques tout au long de leur cycle de vie.

réduire, recycler et réutiliser

Nous avons réduit l'épaisseur de nos produits, ce qui a permis de réduire considérablement les émissions de CO₂.

Nous réutilisons jusqu'à 100 % de l'eau, de l'énergie et des matières premières dans notre production, garantissant ainsi une approche circulaire des ressources.

être compensatoire

Nous produisons de l'énergie solaire dans nos unités industrielles, réduisant ainsi notre dépendance aux sources non renouvelables.

Afin de compenser davantage nos émissions de CO₂, nous investissons dans des crédits carbone, qui sont des certificats achetés par les entreprises pour aider à compenser les émissions de CO₂ qu'elles produisent.

innover et certifier

Nos céramiques sont conçues pour garantir des environnements 100 % exempts de toxines et sont protégées par la technologie antibactérienne Microban.

Elles portent le label **Protect** et des certifications fiables, garantissant leur sécurité et leurs performances.

o que significa ser sustentável?

ser responsável

Através da nossa certificação EDP, medimos o impacto ambiental das nossas superfícies cerâmicas ao longo de todo o seu ciclo de vida.

reduzir, reciclar e reincorporar

Reduzimos a espessura dos nossos produtos, diminuindo significativamente as emissões de CO₂.

Reincorporamos até 100% da água, energia e matérias-primas na produção, garantindo uma abordagem circular aos recursos.

compensar

Produzimos energia solar nas nossas unidades industriais, reduzindo a nossa dependência de fontes não renováveis.

Para compensar ainda mais as nossas emissões de CO₂, investimos em créditos de carbono, que são certificados adquiridos por empresas para ajudar a compensar as emissões de CO₂ que produzem.

inovar e certificar

As nossas cerâmicas são concebidas para garantir ambientes 100% livres de toxinas e são protegidas com a tecnologia antibacteriana Microban.

Possuem o selo **Protect** e certificações de confiança, garantindo segurança e desempenho.

index

colour map

collections

linea collections

useful information

calibers

certification

general sales

conditions

important notes

laying suggestions

margres green

margres tools

outdoor extra thick

package

Protect

sustainable choice

symbols

technical information





inhabit the present live the future

Margres creates ceramic collections to live the present and the future, surrounded by beauty, protected by the quality of an exclusive design of living in total freedom. The same beauty and marvelous harmony that we dream for the world around us.

For this, Margres creates and protects, by reducing to its minimum the environmental impact coming from its activity, through the constant research of the total eco-sustainability in the working environment, on the materials used and in the productive processes, as the obtained environmental certificates demonstrate. We want to contribute for a better world and only what is really eco-sustainable can be considered as development with future vision...

This is our daily commitment and our social responsibility.

sustainable development	commitments
customer services and relationships with other stakeholders	satisfaction of customers and other interested parties, seeking the internationalization of their brands and products in the various markets;
continuous improvement	innovation and product development anticipating the expectations of its customers and ensuring the sustainability of the products throughout their life cycle;
efficiency	implementation of a culture of operational excellence that maximizes the efficiency of processes;
social goals	involvement and motivation of its employees, since they are an important asset for the success of the company;
environmental protection	environmental protection, including pollution prevention, contributing to the minimization of environmental impacts, and opting, whenever possible and economically viable, for the best available technologies, in order to improve environmental performance;
health, safety and well-being	prevention and minimization of risk to the health and safety of employees in order to contribute to their integrity and quality of life;
relationships with society	compliance with the applicable conformity requirements inherent in its activities, products and services.

habiter le present vivre l'avenir

Margres crée des collections pour vivre le présent et l'avenir, encadrés par la beauté, protégés par la qualité d'un design exclusif à vivre en toute liberté.

La même beauté et la même harmonie dont nous rêvons pour notre monde. C'est pour cette raison que Margres crée et protège en réduisant le plus possible l'impact environnemental de son activité, à travers la recherche permanente de l'équilibre écologique dans l'environnement de travail, dans les matières utilisées et dans le processus productif, comme le démontrent les certifications environnementales obtenues. Nous voulons contribuer à ce que vous viviez dans un monde plus beau, plus écologique donc plus développé et d'avenir. Ceci est notre compromis quotidien et notre responsabilité sociale.

développement durable	engagements
service clientèle et autres parties intéressées	la satisfaction des clients et des autres parties prenantes, cherchant l'internationalisation de ses marques et produits sur les différents marchés;
amélioration continue	l'innovation et le développement des produits, avec une prévision des attentes de ses clients, en assurant la durabilité des produits tout au long de leur cycle de vie;
efficacité	la mise en œuvre d'une culture d'excellence opérationnelle qui incite à la maximisation de l'efficacité des processus;
sociaux	l'implication et la motivation de ses employés car ils constituent un actif essentiel pour la réussite de l'entreprise;
protection environnementale	la protection de l'environnement, y compris la prévention de la pollution, contribuant ainsi à minimiser les impacts environnementaux, en optant, lorsque possible et économiquement réalisable, pour la meilleure technologie disponible, afin d'améliorer la performance environnementale;
sécurité, santé et bien-être	la prévention et la réduction des risques pour la santé et la sécurité des employés afin de contribuer à leur intégrité et qualité de vie;
rapport avec la société	respect des obligations de conformité applicables, inhérentes à ses activités, produits et services.

in der gegenwart wohnen, in der zukunft leben

Margres produziert Keramik Kollektionen um in der Gegenwart und der Zukunft zu wohnen, vollkommen in Schönheit, ausgestattet mit der Qualität eines exklusiven Designs, damit Sie in Freiheit leben.

Die gleiche Schönheit und wundervolle Harmonie die wir uns für unsere Umwelt wünschen. Das heißt, dass Margres erschafft und schützt, dabei die Umweltbelastung deren Aktivität auf ein Minimum reduziert, mittels der ständigen Forschung nach der totalen Ökonachhaltigkeit an den Produktionsstätten, den benutzten Materialien, und den Herstellungsprozessen, wie die erlangten Umweltzertifikate darlegen. Wir wollen dazu beitragen in einer besseren Welt zu leben, dabei wissen wir, dass die Ökonachhaltigkeit die Zukunftsentwicklung ist ... Es ist unsere tägliche Anstrengung und soziale Verantwortung.

nachhaltige entwicklung	verpflichtungen
kundenbezogene, aber auch für andere beteiligte zu erbringende leistungen	zufriedenheit der kunden und anderer interessierter beteiligten und streben nach internationalisierung der marken und produkte auf den verschiedenen märkten;
kontinuierliche verbesserungen	innovation und entwicklung der produkte, wobei die erwartungen der kunden vorweggenommen werden, und sicherung der nachhaltigkeit der produkte über den gesamten lebenszyklus hinweg;
effizienz	umsetzung einer kultur der betrieblichen exzellenz, die die maximierung der effizienz der verfahren verstärkt;
betriebsbezogen	einbindung und motivation der mitarbeiter, denn sie stellen die bestimmenden aktiva des unternehmens dar;
umweltschutz	umweltschutz, einschließlich vermeidung von umweltverschmutzung, der zur minimisierung der umweltauswirkungen beiträgt und wo immer dies möglich und wirtschaftlich vertretbar ist, die besten verfügbaren technologien auswählen, um die umweltleistung zu verbessern;
sicherheit, gesundheit und wohlstand	vorbeugung und minimierung der risiken und gefahren für die gesundheit und sicherheit der mitarbeiter, um zur integrität und lebensqualität beizutragen;
firmenbezogen	einhaltung der anwendbaren compliance-verpflichtungen, die mit ihren produkten und dienstleistungen verbunden sind.

habitar o presente viver o futuro

A Margres, cria coleções cerâmicas para habitar o presente e o futuro, plenas de beleza, dotadas da qualidade de um exclusivo design, para viver em liberdade. A mesma beleza e a mesma maravilhosa harmonia que sonhamos para o mundo em nosso redor. Isto é, a Margres, cria e protege, reduzindo ao mínimo o impacto ambiental da sua atividade, por meio da constante pesquisa da total eco sustentabilidade no local de trabalho, nas matérias utilizadas, e nos processos produtivos, como demonstram as certificações ambientais obtidas. Queremos contribuir para que vivamos num mundo melhor, sabendo que a eco sustentabilidade é desenvolvimento olhando para o futuro...

É o nosso esforço quotidiano e a nossa responsabilidade social.

desenvolvimento sustentável	compromissos
serviço ao cliente e restantes partes interessadas	Satisfação dos clientes e restantes partes interessadas, procurando a internacionalização das suas marcas e produtos nos diversos mercados;
melhoria contínua	Inovação e desenvolvimento dos produtos antecipando as expectativas dos seus clientes e assegurando a sustentabilidade dos produtos ao longo do seu ciclo de vida;
eficiência	Implementação de uma cultura de excelência operacional que potencie a maximização da eficiência dos processos;
sociais	Envolvimento e motivação dos seus colaboradores pois constituem um activo determinante para o sucesso da empresa;
proteção ambiental	Proteção do ambiente, incluindo a prevenção da poluição, contribuindo para a minimização dos impactos ambientais e optando sempre que possível e economicamente viável pelas melhores tecnologias disponíveis, a fim de melhorar e desempenho ambiental;
segurança, saúde e bem-estar	Prevenção e minimização do risco para a saúde e segurança dos colaboradores por forma a contribuir para sua integridade e qualidade de vida;
relação com a sociedade	Cumprimento das obrigações de conformidade aplicáveis inerentes às suas atividades, produtos e serviços.

useful information

calibers

certification

general sales

conditions

important notes

laying suggestions

margres green

margres tools

outdoor extra thick

package

Protect

sustainable choice

symbols

technical information



certification

certification . zertifizierung . certificação



The GREENGUARD brand certifies products that guarantee the highest standards of indoor air quality.

All MARGRES collections in porcelain stoneware, monoporous and laminated stoneware have obtained the GREENGUARD GOLD certification, that is, the UL standard with the strictest limits on VOC (Volatile Organic Compounds) emissions, thus being in a position to guarantee the best health conditions for people who live and dwell in indoor spaces. Therefore, they can be used in environments such as schools and healthcare facilities, frequented by sensitive people, such as children and the elderly.

GREENGUARD GOLD is a widely recognised certification, required by sustainable construction programmes and by design and construction regulations around the world, such as LEED (international) and BREEAM (UK).

Die Marke GREENGUARD zertifiziert Produkte, die die höchsten Standards der Luftqualität in Innenräumen garantieren.

Alle MARGRES-Kollektionen aus Feinsteinzeug, Monoporös und laminiertem Feinsteinzeug haben die GREENGUARD GOLD-Zertifizierung erhalten, d.h. die UL-Norm mit den strengsten Grenzwerten für FOV-Emissionen (Flüchtiger Organischer Verbindungen) und sind somit in der Lage, die besten Gesundheitsbedingungen für Menschen, die in Innenräumen leben und wohnen, zu gewährleisten. Daher, können sie in Umgebungen wie Schulen und Gesundheitseinrichtungen eingesetzt werden, die von empfindlichen Menschen wie Kindern und älteren Menschen frequentiert werden.

GREENGUARD GOLD ist eine Zertifizierung, die weithin anerkannt und von nachhaltigen Bauprogrammen und Design- und Bauvorschriften auf der ganzen Welt gefordert wird, wie LEED (international) und BREEAM (UK).

La marque GREENGUARD certifie des produits qui garantissent les plus hauts standards de qualité de l'air dans les espaces intérieurs.

Toutes les collections MARGRES en grès cérame, monoporeuse et grès laminé ont obtenu la certification GREENGUARD GOLD, c'est-à-dire, la norme UL avec les limites les plus strictes d'émissions de COV (composés organiques volatils), étant ainsi en mesure de garantir les meilleures conditions sanitaires aux personnes qui vivent et habitent les espaces intérieurs. Ils peuvent donc être utilisés dans des environnements tels que les écoles et les établissements de santé, fréquentés par des personnes sensibles, comme les enfants et les personnes âgées.

GREENGUARD GOLD est une certification largement reconnue et exigée par les programmes de construction durable et les réglementations de conception et de construction dans le monde entier, telles que LEED (international) et BREEAM (Royaume-Uni).

A marca GREENGUARD certifica produtos que garantem os mais elevados padrões de qualidade do ar em espaços interiores.

Todas as coleções MARGRES em grés porcelânico, monoporosa e grés laminado obtiveram a certificação GREENGUARD GOLD, ou seja, a norma UL com os mais rigorosos limites relativos às emissões de COV (Compostos Orgânicos Voláteis), estando, assim, em condições de garantir as melhores condições de salubridade às pessoas que vivem e habitam espaços interiores. Por conseguinte, podem ser utilizadas em ambientes como escolas e estabelecimentos de saúde, frequentados por pessoas sensíveis, como crianças e idosos.

A GREENGUARD GOLD é uma certificação amplamente reconhecida e exigida pelos programas de construção sustentável e pelos regulamentos de projeto e construção em todo o mundo, tais como o LEED (internacional) e o BREEAM (Reino Unido).

MARGRES
CERAMIC TILES

certification

certification . zertifizierung . certificação

cutting-edge technology

Each raw material used, each productive process and each technology of the complex activity of the Margres sites are studied in order to reduce the environmental impact, by saving, recycling, filtering, with the will of transforming the waste in resources and optimize the use of energy. Margres is on the cutting-edge of adopting ecologically sustainable practices and this is demonstrated by the most accurate controls, repeated on a daily basis.

spitzentechnologie

Jeder benutzte natürliche Rohstoff, jeder Herstellungsprozess und jede Technologie der komplexen Aktivität in den Industriesektoren der Margres werden studiert, um dabei die Umweltbelastung zu reduzieren, zu sparen und zu rezyklieren (verwerten), mit dem Willen, den Abfall in Ressourcen umzuwandeln und den Gebrauch der erzeugten Energie zu optimieren. Margres ist an der Spitze in der Anpassung der nachhaltigen ökologischen Maßnahmen, welche durch die sorgfältigen Kontrollen, die jeden Tag durchgeführt werden, dargestellt werden.



reused non-fired material
réutilisation du tesson
wiederverwendung unbearbeiteter scherben
reutilização de caco cru



recycling of fired material
recyclage du tesson cuit
recycling von erhitzten scherben
reciclagem de caco cozido



water recycling from the manufacturing process
recyclage des eaux du processus productif
recycling von in verfahren benutzt wasser
reciclagem de água do processo



low gas emissions to the atmosphere
faibles émissions de gaz dans l'atmosphère
geringe abgabe gashaltiger emissionen in die atmosphäre
baixas emissões gasosas para a atmosfera

technologie d'avant-garde

Chaque matière première, chaque processus productif et chaque technologie de la complexe activité des établissements de Margres sont étudiés de façon à limiter l'impact environnemental en épargnant, recyclant et filtrant avec la volonté de transformer les gâchis en ressources et optimiser l'usage de l'énergie produite. Margres est à l'avant-garde dans l'action et les pratiques pour l'environnement comme le démontrent les contrôles les plus exigeants répétés au quotidien.

tecnologia de vanguarda

Cada matéria prima natural utilizada, cada processo produtivo e cada tecnologia da complexa atividade das unidades industriais da Margres, são estudadas de forma a minimizar o impacto ambiental, poupando, e reciclando, com a vontade de transformar desperdícios em recursos e otimizar a utilização da energia produzida. A Margres está na vanguarda na adoção de medidas ecologicamente sustentáveis as quais são demonstradas pelos mais minuciosos controles quotidianamente efetuados.



energy saving
économie d'énergie
energieeinsparung
poupança de energia



100% recycled materials used in our packing
100% de matériaux recyclables utilisés dans l'emballage
100% recycling-material wird für verpackungen benutzt
100% de materiais recicláveis utilizados na embalagem



ceramic products sustainability
durabilité des produits céramiques
nachhaltigkeit von keramikprodukten
sustentabilidade dos produtos cerâmicos



FSC Pallets and Cardboard
Palettes et carton FSC
FSC Paletten und Kartons
Paletes e cartão FSC

index

colour map

collections

linea collections

useful information

calibers

certification

general sales

conditions

important notes

laying suggestions

margres green

margres tools

outdoor extra thick

package

Protect

sustainable choice

symbols

technical information



certification

certification . zertifizierung . certificação



certification

certification . zertifizierung . certificação

index

colour map

collections

linea collections

useful information

calibers

certification

general sales

conditions

important notes

laying suggestions

margres green

margres tools

outdoor extra thick

package

Protect

sustainable choice

symbols

technical information



the environment certification

Margres have obtained the most prestigious International environmental certifications. Agencies and control bodies have officially recognized the work done by the company for the safeguarding of the earth's natural resources. These certifications are proof of the high standards attained by Margres, a company which is a forerunner in terms of sustainable development. These are a clear proof of how it is possible to reconcile quality, industrial innovation and design with a serious policy for environmental safeguard.

umweltzertifizierung

Die Einrichtungen der Margres haben internationale Umweltzertifikate von hohem Ansehen erhalten. Überwachungsbehörden und Überwachungseinrichtungen haben offiziell die vollendeten Tätigkeiten des Unternehmens zur Wahrung der natürlichen Ressourcen des Planeten anerkannt. Diese Zertifikate bescheinigen die bewährten Umweltmethoden der Margres zum Schutz der nachhaltigen Entwicklung. Dies ist eine eindeutige Veranschaulichung der Möglichkeit, wie man Qualität, industrielle Innovation und Design mit einer ernsten Politik des Umweltschutzes abstimmen kann.

la certification environnementale

Les établissements Margres ont obtenu de prestigieuses certifications environnementales internationales. Les entités et les organismes de contrôle ont officiellement reconnu le travail fourni par ces entreprises pour la préservation des ressources naturelles de la planète. Cette certification témoigne des bonnes pratiques environnementales de Margres, dans la protection du développement durable. C'est une démonstration concrète de l'engagement de l'entreprise en termes de Qualité, d'Innovation et de Design, le tout allié à une sérieuse politique de protection de l'environnement.

a certificação ambiental

Os estabelecimentos da Margres obtiveram certificações ambientais internacionais de grande prestígio. Entidades e organismos de controlo reconheceram oficialmente o trabalho feito pela empresa para a salvaguarda dos recursos naturais do planeta. Esta certificação testemunha as boas práticas ambientais da Margres, na salvaguarda do desenvolvimento sustentável. Esta é uma demonstração concreta de como é possível conciliar Qualidade, Inovação Industrial e Design com uma séria política de salvaguarda do ambiente.

MARGRES
CERAMIC TILES



ISO 14001

for production sites with low impact and high efficiency . produit fabriqué sans négliger l'environnement
Produktherstellung unter Einbeziehung der Umwelt . para estabelecimentos de baixo impacto ambiental e alta eficiência.



EMAS

being green and transparent . pour être vert et transparent
grün und transparent . para ser verde e transparente



LEED U.S. GREEN COUNCIL

a brand for the environment . une marque pour l'environnement
eine Marke für die Umwelt . uma marca para o ambiente



GREEN BUILDING COUNCIL ITALY

for a new culture in construction . pour une nouvelle culture de construction
für einer neues Aufbaukultur . para uma nova cultura de construção



HPD

health product declaration . déclaration de santé du produit
gesundheitsproduktdeklarationen . declaração de saúde do produto



EPD

the environmental product declaration . la déclaration environnementale de produit
die umwelt-produktdeklaration . a declaração ambiental de produto



sustainability report, consult . rapport de durabilité, consultez
nachhaltigkeitsbilanz, siehe unter . relatório de sustentabilidade, consulte
grespanaria.com

certification

certification . zertifizierung . certificação

EMAS



certification

certification . zertifizierung . certificação

APCER



IQNET



index

colour map

collections

linea collections

useful information

calibers

certification

general sales

conditions

important notes

laying suggestions

margres green

margres tools

outdoor extra thick

package

Protect

sustainable choice

symbols

technical information



certification

certification . zertifizierung . certificação



CSTB

Centre Scientifique et Technique du Bâtiment

CERTIF

The quality of the Margres porcelain ceramic tile has been certified by the main institutions in the field, namely the Centre Scientifique et Technique du Bâtiment in France, benefiting from the prestige of the QB-UPEC brand mark and for CERTIF in Portugal.

A qualidade do grês cerâmico de Margres a obteve o certificado das principais instituições de la especialidade notadamente do Centre Scientifique et Technique du Bâtiment en France, jouissant du prestige de produit de marque QB-UPEC et par CERTIF au Portugal.

Die Qualität des Feinsteinzeugs von Margres ist von den wichtigsten Institutionen dieses Fachbereichs zertifiziert, namentlich das Centre Scientifique et Technique du Bâtiment in Frankreich, das ihm die Klassifizierung QB-UPEC verlieh, und das CERTIF in Portugal.

A qualidade do Grês Porcelânico da Margres encontra-se certificada pelas principais instituições da especialidade, nomeadamente pelo Centre Scientifique et Technique du Bâtiment França, usufruindo deste o prestígio de produto de marca QB-UPEC e pela CERTIF em Portugal.

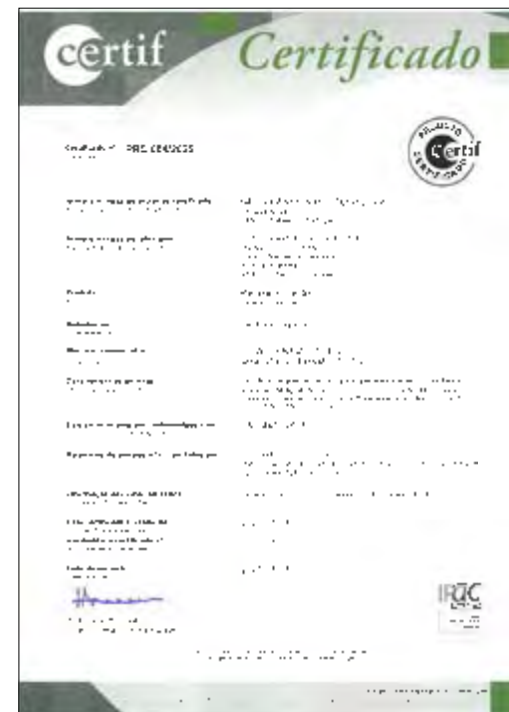

certification

certification . zertifizierung . certificação



concept	P. 189		
deck plus	P. 85		
endless	P. 125		
evoke	P. 169		
evolution	P. 57		
hybrid	P. 157		
metropolis	P. 93		
prestige	P. 179		
pure stone	P. 137		
slabstone	P. 223		
stage	P. 111		
subway	P. 233		
tecnica	P. 255		
thunder	P. 73		
time 2.0	P. 241		
tool	P. 211		



pour plus d'informations, consultez <https://evaluation.cstb.fr>



for more information, consult <https://margres.com/en/company>
 pour plus d'informations, consultez <https://margres.com/fr/institutionnel>
 Weitere Informationen finden Sie unter <https://margres.com/de/firma>
 para mais informações, consulte <https://margres.com/pt/empresa>



index

colour map

collections

linea collections

useful information

calibers

certification

general sales

conditions

important notes

laying suggestions

margres green

margres tools

outdoor extra thick

package

Protect

sustainable choice

symbols

technical information



intended uses

domaines d'emploi . verwendungszwecke . utilizações previstas

The characteristics of the product and the ease of installation, both with or without adhesive (dry installation on grass, gravel, or elevated floors), make the 20MM thick porcelain tile by Margres the best solution for external flooring of public and residential areas, such as urban spaces, pavements, garden paths, car parks, terraces, swimming pool edges, bathing facilities, parks and much more.

The best solution to match external and internal spaces.

Les caractéristiques du produit ainsi que l'extrême facilité de pose aussi bien à sec (sur herbe, gravier, sols surélevés) qu'avec adhésif, font du grès cérame Margres épaisseur 20MM, la meilleure solution pour les pavages externes de zones publiques et résidentielles: places urbaines, trottoirs, voies piétonnes, parkings, terrasses, bords de piscine, établissements balnéaires, aménagement public paysager et bien d'autres domaines encore.

Une solution optimale pour obtenir un ensemble parfaitement coordonné entre intérieur et extérieur.

Die Produkteigenschaften und extreme Einfachheit sowohl der Trockenverlegung (auf Gras, Kies, als Doppelboden) als auch der Klebverlegung, machen das Feinsteinzeug von Margres mit 20MM Stärke zur besten Lösung bei Bodenbelägen im Außenbereich von öffentlichen und privaten Anlagen: Stadtplätze, Bürgersteige, Wege, Parkplätze, Terrassen, Poolumrandungen, Badeanlagen, öffentliche Grünanlagen und vieles mehr.

Die beste Lösung um eine optimale Koordination zwischen Innen- und Außenbereich zu erhalten.

As características técnicas bem como a facilidade de instalação, com ou sem colas (instalação a seco em relva, gralilha ou pavimentos sobrelevados), fazem das placas cerâmicas Margres 20MM a melhor solução para a pavimentação de espaços exteriores sejam eles públicos ou privados, tais como jardins, garagens, caminhos pedonais, terraços, piscinas, áreas urbanas, etc.

Trata-se igualmente de uma boa solução para combinar espaços interiores e exteriores.



instructions for matching sizes and pedestals in elevated floor installation

instruction pour le couplage des formats et supports lors de la pose surélevée
anweisungen für die verbindung von formaten und auflagen bei der verlegung von doppelböden
instruções de combinação de tamanhos e suportes na aplicação sobreelevada

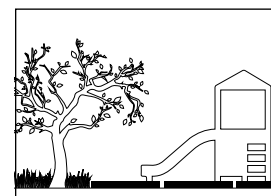
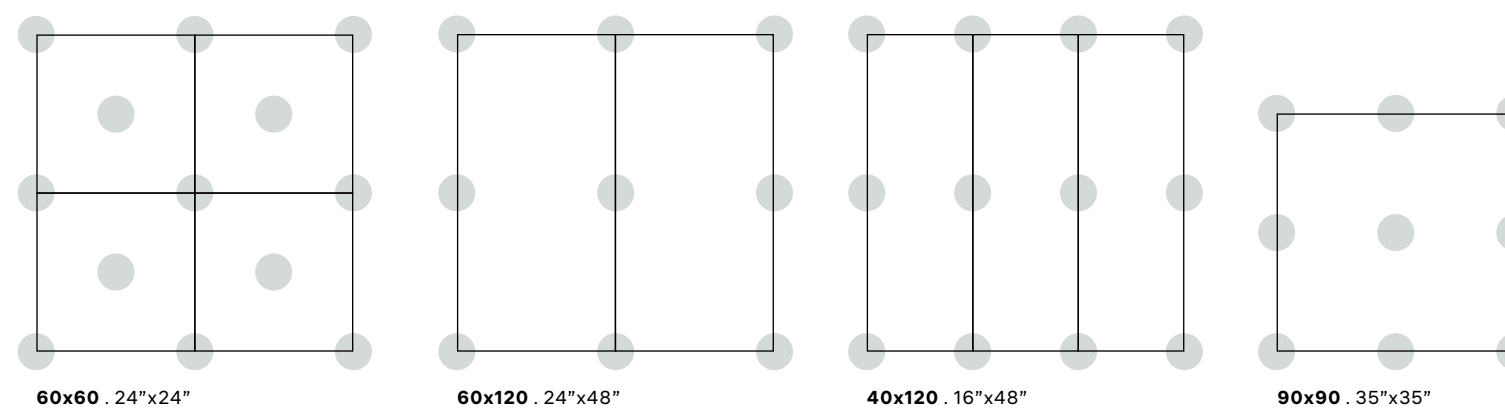

gardens and public areas
jardins et espaces publics
gärten und öffentliche anlagen
jardins e espaços públicos

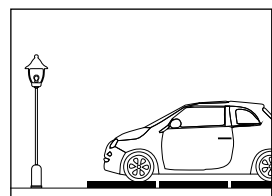

parking lots
parkings
parkplätze
parques de estacionamento

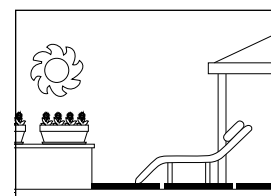

terraces
terrasses
terrassen
terraços

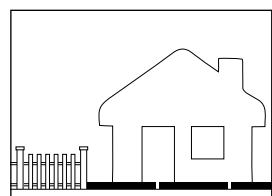

sidewalks and pedestrian areas
chaussées, zones piétonnes
bürgersteige, zugänge und andere fußgängerzonen
calçadas, acessos e zonas pedonais

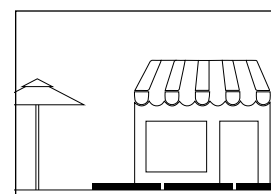

seaside resorts
complexes balnéaires
badekomplexe und seebäder
complexos e estâncias balneares

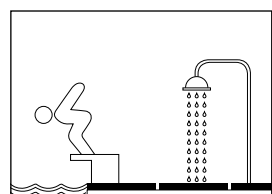

pool surrounding areas
contours de piscines
bereiche in der umgebung von schwimmbecken
envolventes de piscina

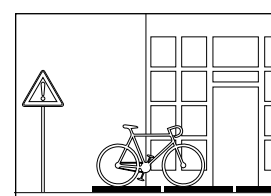

urban areas
zones urbaines
städtische gebiete
áreas urbanas

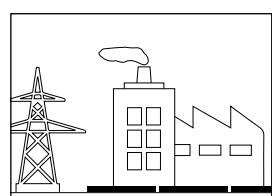

industrial areas
zones industrielles
industriegebiete
zonas industriais



special pieces

pièces spéciales . spezialteile . peças especiais

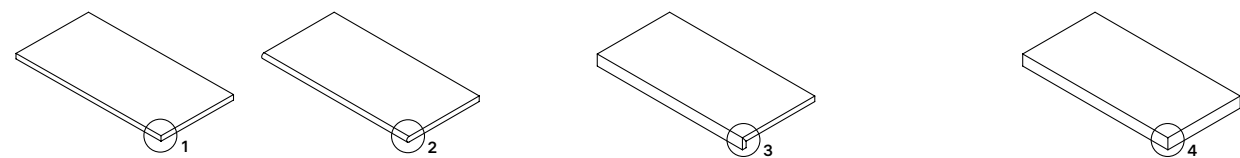
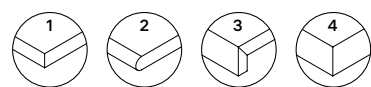

	straight edge margelle stufenplatte base 30x60 E ASR	bullnose margelle arrondie stufenplatte abgerundet base boleada 30x60 E ASR	step tread "L" 20mm nez de marche "L" 20mm stufenplatte "L" 20mm degrau "L" 20mm 30x60E ASR	30x90E ASR	30x120 E ASR	step tread "L" 20mm corner* nez de marche "L" 20mm angle* ecke stufenplatte "L" 20mm* degrau "L" 20mm canto* 30x60E ASR	30x90 E ASR	30x120 E ASR
bare&bold	MP-6490	MP-6500	MP-6590	-	MP-6685	MP-6680	-	MP-6740
deck plus	MP-6490	MP-6500	MP-6590	-	MP-6685	MP-6680	-	MP-6740
evoked	MP-6490	MP-6500	MP-6590	MP-6640	MP-6685	MP-6680	MP-6700	MP-6740
evolution	MP-6490	MP-6500	MP-6590	MP-6640	-	MP-6680	MP-6700	-
grove	MP-6490	MP-6500	MP-6590	-	MP-6685	MP-6680	-	MP-6740
pure stone	MP-6490	MP-6500	MP-6590	-	MP-6685	MP-6680	-	MP-6740
slabstone	MP-6490	MP-6500	MP-6590	-	-	MP-6680	-	-
subway	MP-6490	MP-6500	MP-6590	-	-	MP-6680	-	-
thunder	MP-6490	MP-6500	MP-6590	MP-6640	-	MP-6680	MP-6700	-
tool	MP-6490	MP-6500	MP-6590	-	-	MP-6680	-	-

* Available in right and left corner. Disponible dans les coin droit et gauche . Erhältlich in der rechten Ecke und links. Disponível no canto direito e esquerdo

step tread "L" 20mm
nez de marche "L" 20mm
stufenplatte "L" 20mm
degrau "L" 20mm

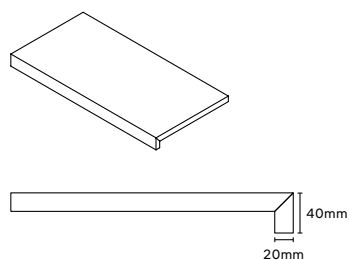

step tread "L" 20mm corner
nez de marche "L" 20mm angle
ecke stufenplatte "L" 20mm
degrau "L" 20mm canto

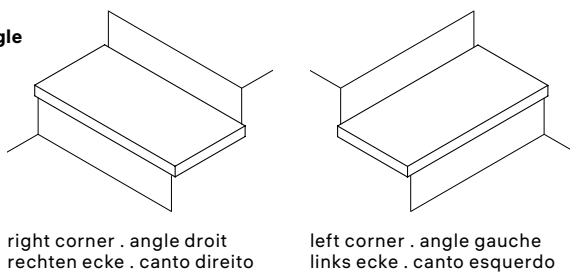

deck plus . special pieces

pièces spéciales . spezialteile . peças especiais

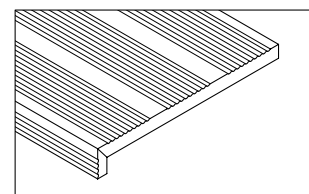

step tread "L" 20mm
nez de marche "L" 20mm
stufenplatte "L" 20mm
degrau "L" 20mm

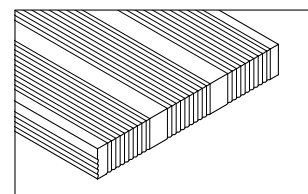

step tread "L" 20mm corner
nez de marche "L" 20mm angle
ecke stufenplatte "L" 20mm
degrau "L" 20mm canto

swimming pool edges

margelles de piscine . beckenrandsteine . bordos de piscina

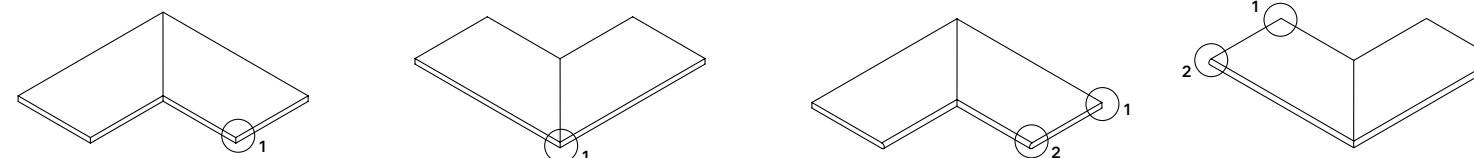
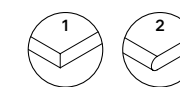

straight edge inner corner
margelle angle bord droit intérieur
eckstufe
canto interior
30x60

E ASR MP-6620
(sold per two pieces set . vendu à la paire
paarweise verkauft . vendida ao par)

straight edge outer corner
margelle angle bord droit extérieur
eckstufe außenseite
canto exterior
30x60

E ASR MP-6620
(sold per two pieces set . vendu à la paire
paarweise verkauft . vendida ao par)

bullnose inner corner
margelle bord intérieur arrondi
abgerundete innenecke (gärung)
canto interior boleado
30x60

E ASR MP-6650
(sold per two pieces set . vendu à la paire
paarweise verkauft . vendida ao par)

bullnose outer corner
margelle bord extérieur arrondi
abgerundete aussenecke (gärung)
canto exterior boleado
30x60

E ASR MP-6650
(sold per two pieces set . vendu à la paire
paarweise verkauft . vendida ao par)

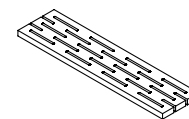

overflow grille MG
grille MG
überlauf MG
grelha MG
15x60

E ASR MP-6520

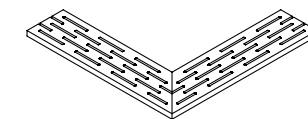

overflow corner grille MG
angle grille MG
überlauf ecke MG
canto grelha MG
15x60

E ASR MP-6700
(sold per two pieces set . vendu à la paire
paarweise verkauft . vendida ao par)

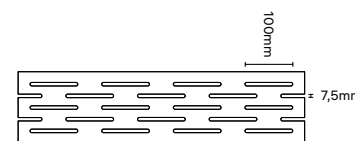

Available in all 20mm thickness ranges.
Disponible dans toutes les collections avec épaisseur 20mm.
Verfügbar in allen 20mm Stärke Serien.
Disponível em todas as coleções com espessura 20mm.

Anti-slip finish doesn't have antibacterial protection.
La finition antidérapante n'a pas de protection antibactérienne.
Die rutschfeste Oberfläche hat keinen antibakteriellen Schutz.
O acabamento antiderrapante não tem proteção antibacteriana.

deck plus . special pieces

pièces spéciales . spezialteile . peças especiais

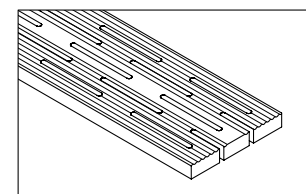

overflow grille . corner grille MG
grille . angle grille MG
überlauf . überlauf ecke MG
grelha . canto grelha MG



technical information

— information technique . technische information . informação técnica

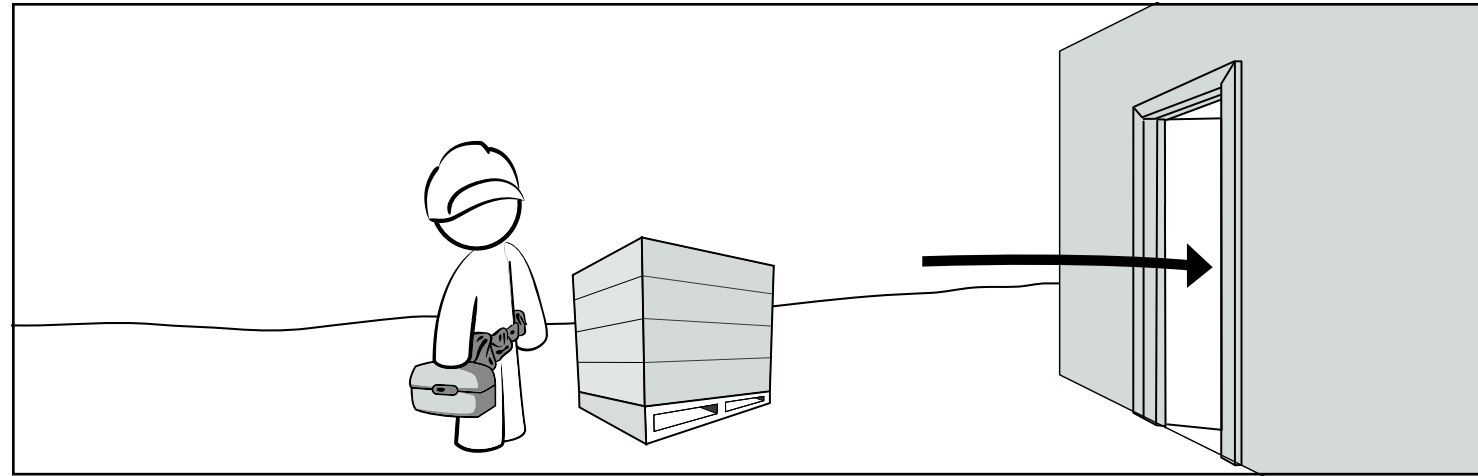

Before (beginning the) laying (of) ceramic material, you should take the following aspects into account:

- Check if the ceramic material is suitable for (use at) the selected site, according to its specifications and technical characteristics;
- Check whether there is enough material to conclude the work;
- Check the boxes to see/confirm in the boxes if the product is in the same shade, choice and caliber;
- Claims regarding these items cannot be accepted after tile setting.

The good performance of the ceramic material depends strongly on the conditions of application for which it is extremely important to ensure the following assumptions:

Avant de commencer la pose du matériau céramique, les aspects suivants devront être pris en considération:

- Vérifier si le matériau céramique est indiqué pour une utilisation dans le lieu choisi, conformément à ses spécifications et caractéristiques techniques;
- Vérifier s'il existe la quantité de matériau suffisante pour réaliser le chantier;
- Confirmer dans les boîtes si le produit est du même ton, de la même qualité, et du même calibre;
- Les réclamations relatives au matériel déjà posé ne pourront pas être acceptées.

La bonne performance du matériau céramique dépend fortement des conditions d'application. Il est donc extrêmement important de garantir les conditions préalables suivantes:

Vor dem Beginn der Verlegearbeiten sollten Sie folgende Punkte berücksichtigen:

- Bitte überprüfen Sie, ob die gewählte Fliese laut ihrer Oberflächenbeschaffenheit und ihren technischen Eigenschaften geeignet für das Einsatzgebiet ist;
- Bitte prüfen Sie nach, ob die Menge der gewählten Fliese ausreicht, um das geplante Bauprojekt fertig zu stellen;
- Bitte prüfen Sie, ob die Fliesen aus verschiedenen Kartons dieselbe Beschaffenheit, (Ton, Wahl und Kaliber) haben;
- Diesbezügliche Beanstandungen können nach der Verlegung nicht berücksichtigt werden.

Die Leistungsfähigkeit der Fliese hängt stark davon ab, wie die Fliesen verlegt werden. Daher ist es sehr wichtig, die folgenden Punkte zu beachten:

Antes de iniciar o assentamento do material cerâmico, deverá ter em consideração os seguintes aspetos:

- Verificar se o material cerâmico é indicado para utilizar no local selecionado de acordo com as suas especificações e características técnicas;
- Verificar se existe material suficiente para realizar a obra;
- Confirmar nas caixas se o produto é da mesma tonalidade/lote, escolha e calibre;
- Não se aceitem reclamações relativas a materiais já aplicados.

O bom desempenho do material cerâmico depende fortemente das condições de aplicação pelo que é de extrema importância garantir os seguintes pressupostos:

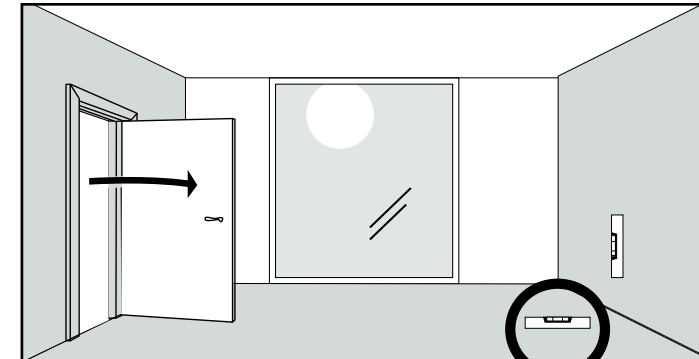

01

support

The support must be stable, free of debris, dust and cracks. Curing times and stability of the treatments to which the support may have been subjected should be respected.

You should check its flatness and stabilize it, if necessary with the help of products suitable for the purpose.

These aspects are vital for wall and floor ceramic tiles.

le support

Le support doit être stable, exempt de résidus, fentes et poussières. Les temps de durcissement et de stabilité des traitements auxquels il doit être soumis devront être respectés.

La planéité du support doit être vérifiée et le nivellement doit être réalisé si cela est nécessaire, à l'aide de produits appropriés.

Ces aspects sont essentiels pour les revêtements de sol et muraux céramiques.

der untergrund

Der Untergrund muss stabil, sauber, sowie frei von Rissen und Staub sein. Sollte der Untergrund vor dem Verlegen der Fliesen speziell behandelt werden müssen, so sollten Sie darauf achten, dass die Behandlung gut gelungen und abgeschlossen ist, bevor Sie die Fliesen verlegen.

Sie sollten den Untergrund inspizieren. Falls er nicht eben ist, muss er mit Hilfe von passenden Produkten grundiert werden.

Diese Vorsicht ist angebracht und eine unabdingbare Voraussetzung für das fachgerechte Verlegen von Boden- und Wandfliesen.

o suporte

O suporte deve apresentar-se estável, limpo de resíduos, fendas e poeiras. Deverão ser respeitados os tempos de cura e estabilidade dos tratamentos a que possa ter sido sujeito.

Deve fazer-se a verificação da planaridade do mesmo, procedendo à regularização, se necessário com a ajuda de produtos adequados a esse fim.

Estes aspetos são vitais para pavimentos e revestimentos cerâmicos.

technical information

information technique . technische information . informação técnica

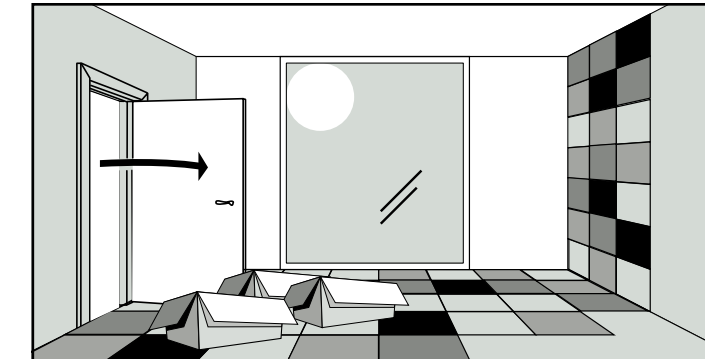

02

material

For a better visual effect of the product, it is advisable to use alternating ceramic pieces taken from various packages simultaneously.

If the product has shade variations or has different graphics and shades, it should be applied randomly.

le matériau

Pour obtenir un meilleur effet visuel avec le produit, il est conseillé d'utiliser de forme alternée des pièces céramiques retirées simultanément de plusieurs emballages.

Si le produit est dénuancé ou a un aspect graphique différent et une tonalité différente, il devra être appliqué de forme aléatoire.

das material

Damit Sie das beste Ergebnis erzielen, ist es ratsam, die Fliesen immer aus verschiedenen Paketen zu wählen und in regelmäßig abwechselnder Folge zu verlegen.

Falls das Produkt diverse Farbschattierung, einen unterschiedliche Farbton oder grafisches Design aufweist, müssen die Fliesen auf diese Weise verlegt werden.

o material

Para obter um melhor efeito visual do produto, aconselha-se a utilização, alternada, de peças cerâmicas retiradas de várias embalagens em simultâneo.

Caso o produto seja destonalizado ou tenha gráfica e tonalidade diferente, deverá ser aplicado de forma aleatória.

index

colour map

collections

linea collections

useful information

calibers

certification

general sales

conditions

important notes

laying suggestions

margres green

margres tools

outdoor extra thick

package

Protect

sustainable choice

symbols

technical information



technical information

— information technique . technische information . informação técnica

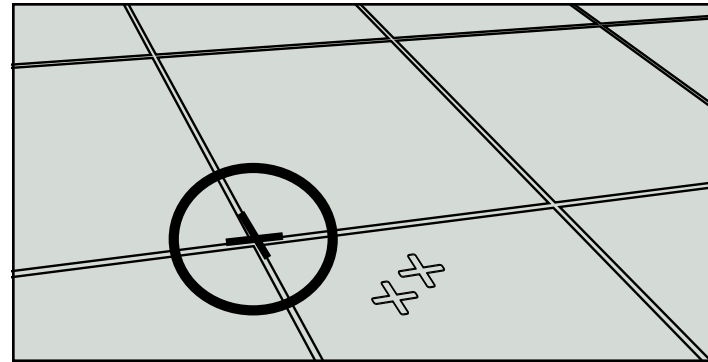

≥ 2mm ≥ 3mm

03

joins for tile-laying

For a perfect application of the ceramic pieces, you should definitely use joints. They fulfill important aesthetic and technical functions, facilitating alignment of the materials, absorbing any possible deformation liable to be felt in the structure - floor and wall - thus preventing the transmission of deformations to the ceramic pieces.

We advise the use of leveling systems when applying big ceramic formats material.

Use the minimum recommended joints so as to ensure a good aesthetic aspect of the ceramic pieces, and respect the rules of application as follows.

NOTE: Regardless of the values presented here, the person applying it should always follow the regulations of the countries where he is doing this application work.

joins de pose

L'utilisation de joints de pose est obligatoire afin d'obtenir une pose parfaite des pièces céramiques,. Ils remplissent une importante fonction esthétique et technique. Ils facilitent l'alignement des matériaux et absorbent d'éventuelles déformations qui peuvent se produire dans la structure – sols et murs – et empêchent donc la transmission de ces déformations aux pièces céramiques. Nous recommandons l'utilisation de niveleurs lors de l'application de matériaux de grand format

Utiliser Les joints minimaux recommandés afin de garantir un bon aspect esthétique des pièces céramiques et respecter les normes d'application sont les suivants.

REMARQUE: Indépendamment des valeurs ici présentées, l'applicateur devra toujours suivre les réglementations du pays où il réalise ce travail d'application.

das verfugen

Um die keramischen Platten perfekt zu verlegen, sollten Sie die Wand oder den Boden ordnungsgemäß verfugen. Die Fugen haben wichtige ästhetische und technische Funktionen. Sie erleichtern das Aufreihen der Fliesen; sie absorbieren eventuelle Verformungen der Wand oder des Bodens, und vermeiden dadurch die Übertragung dieser Verformungen auf die Fliesen.

Wir empfehlen die Benutzung von selbstnivellierenden Abstandhaltern, wenn es darum geht, Fliesen von groesseren Formaten zu verlegen, wie zum Beispiel Die empfohlenen Fugenbreiten, welche eine schöne Optik sowie eine regelgerechte Verlegung gewährleisten, sind nachfolgend angegeben.

WICHTIG: Abgesehen von den oben angegebenen Fugenbreiten, muss der Fliesenleger immer den jeweils geltenden landesspezifischen Vorschriften Folge leisten.

juntas de assentamento

Tendo em vista uma perfeita aplicação das peças cerâmicas, deve usar-se obrigatoriamente juntas de assentamento. Estas cumprem importantes funções estéticas e técnicas, facilitando o alinhamento dos materiais, absorvendo eventuais deformações que se possam fazer sentir na estrutura – chão e parede – e impedindo, assim, a transmissão destas deformações às peças cerâmicas.

Aconselhamos a utilização de niveladores aquando da aplicação de material de grandes formatos.

Utilizar as juntas mínimas recomendadas de forma a garantir um bom aspeto estético das peças cerâmicas, bem como respeitar as normas de aplicação.

NOTA: independentemente dos valores aqui apresentados, o aplicador deverá sempre seguir as normativas dos países onde está a fazer este trabalho de aplicação.

	application . pose . anwendung . aplicação		
finishing finition fertigung acabamento	indoor intérieur innen interior	outdoor extérieur außen exterior	raised floor dalles sur plot doppelboden sobreelevado
non rectified non rectifié presskante não retificado	3mm	4mm *	-
rectified rectifié rektifiziert retificado	2mm	3mm *	-
20mm rectified 20mm rectifié 20mm rektifiziert 20mm retificado	2mm	3mm *	3mm

*
It's recommended to increase in 2mm the minimum joint in the darker colours. For further information please go to our website and read product's technical data sheet.

pour les couleurs foncées il est recommandé de rajouter 2mm au joint minimum. Consultez la fiche technique du produit respectif sur le site web.

Bei dunklen Farben wird empfohlen, 2 mm zur Mindestfuge noch weiter hinzuzufügen. Konsultieren Sie das technische Datenblatt des Produkts auf der Website.

para as cores escuras recomenda-se acrescentar 2mm à junta mínima. Consultar a ficha técnica do respetivo produto no site.

MARGRES
CERAMIC TILES

technical information

information technique . technische information . informação técnica

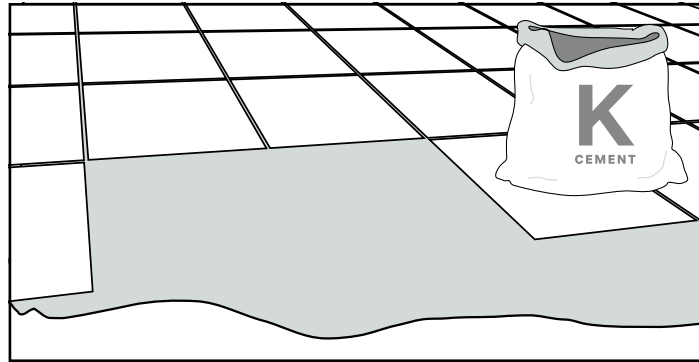

04

glue and mortar

The mortars, grouting mortars, glue-cements, and glues to be used should take into account both the support and the intended purpose of the ceramic pieces - indoor, outdoor, wall, floor - and their typology – Porcelain stoneware. You should follow the instructions provided by the manufacturer on its use.

colle et mortiers

Les mortiers, mortiers de rejointoiment, ciments-colles et colles à utiliser devront tenir compte du support et de la fin à laquelle sont destinées les pièces céramiques - intérieur, extérieur, mur, plancher - ainsi que de leur typologie - Grès cérame. Vous devrez suivre les instructions indiquées par le fabricant pour son utilisation.

kleber und mörtel

Welchen Mörtel, welchen Zementkleber oder welche andere Verbundmittel Sie am besten verwenden, hängt sowohl vom Untergrund als auch vom Material (Monoporosa, glasierte Fliesen) ab. Es kommt ebenso darauf an, ob die Fliesen im Außen- Feinsteinzeug. Bitte befolgen Sie die Herstellerangaben zum Gebrauch des Produktes.

cola e argamassas

As argamassas, argamassas de rejuntamento, cimentos-colas e colas a utilizar deverão ter em conta o suporte e o fim a que se destinam as peças cerâmicas - interior, exterior, parede, pavimento - e a sua tipologia - Grés porcelânico. Deverá seguir as instruções indicadas pelo fabricante sobre a sua utilização.

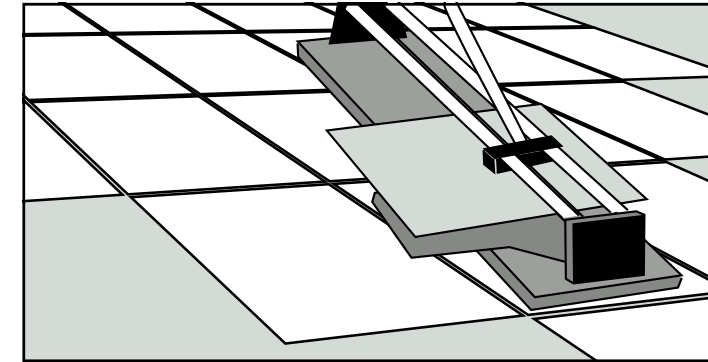

05

cutting instructions

We recommend wet cutting or the score and snap method during the installation process.

Do not dry cut using power tools during the installation process. Improper installation techniques could expose installer to harmful silica dust.

instructions de découpe

Nous recommandons la découpe avec refroidissement d'eau ou usage d'un découpant manuel avec méthode de marquage et decoupage pendant la pose. Ne pas utiliser d'outils électriques ou de decoupage à sec pendant la pose. Des techniques de pose inadéquates pourront exposer le poseur à des poussières de silice et nuire à la santé.

schneideempfehlung

Wir empfehlen das Nassschneiden oder die Ritz- und Brechmethode während des Installationsprozesses. Während des Installationsvorgangs nicht mit Elektrowerkzeugen trocken schneiden. Durch unsachgemäße Installationstechniken kann der Installateur schädlichem Quarzstaub ausgesetzt werden.

instruções de corte

Recomendamos o corte com arrefecimento de água ou utilização de cortador manual com método de marcação e corte durante o processo de instalação. Não usar ferramentas elétricas com corte a seco durante o processo de instalação.

Técnicas de instalação impróprias poderão expor o instalador à poeira de sílica de forma prejudicial.

index

colour map

collections

linea collections

useful information

calibers

certification

general sales

conditions

important notes

laying suggestions

margres green

margres tools

outdoor extra thick

package

Protect

sustainable choice

symbols

technical information



technical information

— information technique . technische information . informação técnica

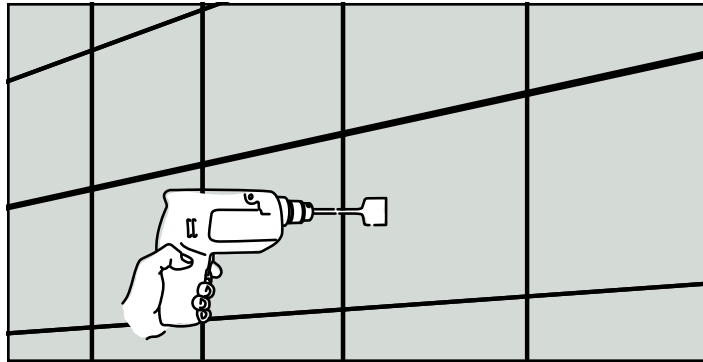

06

holes

For drilling you should use diamond twist drills with a diameter adaptable to the desired hole.

perçages

Pour le perçage, utiliser des trépan diamantés avec un diamètre adapté au trou désiré.

löcher

Löcher sollten im gewünschten Durchmesser mittels einer Diamanthammerbohrkrone in die Fliese gebohrt werden.

furos

Na furação deverão ser utilizadas brocas cranianas diamantadas com diâmetro adaptável ao furo pretendido.

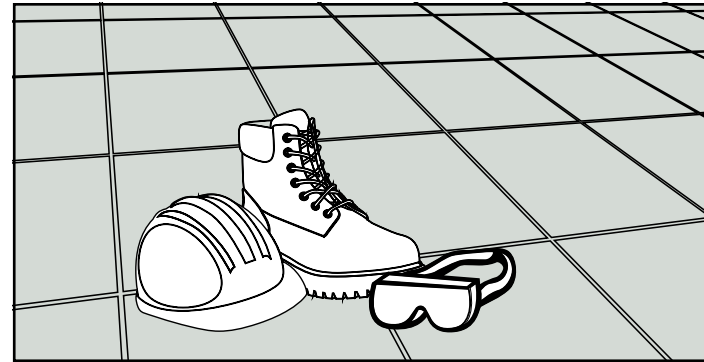

07

safety and preparation for laying the material

We advise the use of appropriate PPE (personal protective equipment), namely safety footwear, protective gloves and even goggles (safety glasses) and hearing protection in operations of cutting material.

Good practices must be followed in terms of lifting and carrying loads.

sécurité lors de la préparation et de la pose du matériau

Il est conseillé d'utiliser un EPI (équipement de protection individuelle) approprié, notamment des chaussures de sécurité, des gants de protection, mais aussi des lunettes et une protection auditive lors des opérations de coupe du matériau. Respectez les bonnes pratiques concernant le levage et le transport manuel de charges devront être appliquées.

sicherheitshinweise für das verlegen von fliesen

Wir empfehlen Ihnen, immer die passende Schutzkleidung zu tragen. Wir ermahnen Sie eindringlich, Schutzschuhe, -handschuhe, -brille sowie Gehörschutz zu benutzen, wenn Sie die Fliesen zuschneiden. Achten Sie bitte auf die richtige Körperhaltung, wenn Sie Lasten heben und tragen.

segurança na preparação e assentamento do material

Aconselha-se a utilização de EPI (equipamento de proteção individual) adequado, nomeadamente, calçado de segurança, luvas de proteção e ainda óculos e proteção auditiva nas operações de corte do material. Devem ser cumpridas as boas práticas a nível do levantamento e transporte manual de cargas.

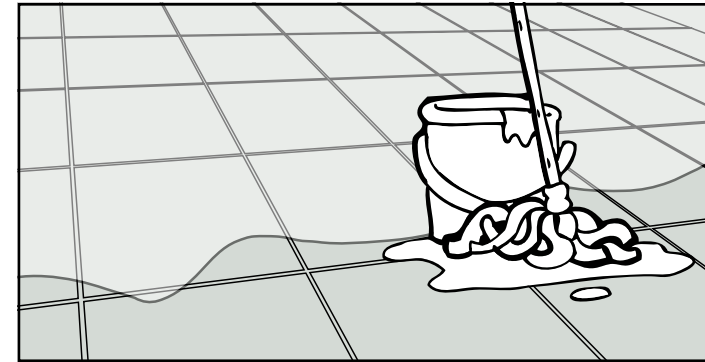

08

protection and cleaning

All residues of glue and grout mortar should be cleaned from the surface of the parts immediately after application and in accordance with the manufacturer's instructions.

Immediately after the laying of ceramic material it is recommended that the ceramic parts are / will be duly protected. For dirt removal after the work, such as left-over joints, cements, etc., it is recommended that you use a buffered descaling acid to remove all residues.

In daily maintenance, ordinary detergents may be used, respecting the dilutions recommended by the respective manufacturer.

Regarding decorated pieces, you should avoid the use of abrasive cleansers that may damage the pieces.

Pieces decorated through the depositing of titanium particles - Gold, Silver and Copper - which give them a metallic aspect should be handled with care. The final cleaning and maintenance of this type of product should be made with detergents suitable for metals - stainless steel brightener - so as to create an antistatic effect that can repel dirt and protect the product from fats and corrosion.

Regular cleaning of the product should be done with a damp cloth moisturized with water or window cleaner, and after it gets dry, a dry cloth shall be used.

protection et nettoyage

Tous les résidus de colle et de mortier de jointoiment doivent être nettoyés de la surface des pièces immédiatement après l'application et conformément aux instructions du fabricant.

Immédiatement après la pose du matériau céramique, il est recommandé de protéger correctement les pièces céramiques. Pour l'élimination de la saleté résultant des travaux, comme les résidus de joints, ciments, etc., il est recommandé d'utiliser un acide tamponné désincrustant.

L'entretien quotidien pourra être réalisé avec des détergents ordinaires, en respectant les dilutions recommandées par le fabricant respectif.

Pour les pièces décorées, l'utilisation de produits de nettoyage abrasifs devra être évitée car ils pourront endommager les pièces.

Les pièces décorées grâce au dépôt de particules de titane - Gold, Silver et Copper - qui lui confèrent un aspect métallique, devront être manipulées avec soin. Le nettoyage final et d'entretien de ce type de produit devra être réalisé avec des détergents spécifiques pour les métaux - agent de brillantage d'acier inox - afin de créer un effet antistatique qui puisse repousser la saleté et protéger le produit des graisses et de la corrosion.

Le nettoyage régulier du produit doit être effectué avec un chiffon imbibé d'eau ou de nettoyant pour vitres et, après séchage, on doit passer un chiffon sec.

technical information

information technique . technische information . informação técnica

schutz und reinigung

Alle Rückstände von Klebstoff und Fugenmörtel sollten von der Oberfläche der Stücke unmittelbar nach dem Auftragen und in Übereinstimmung mit den Anweisungen des Herstellers gereinigt werden.

Bitte vergessen Sie nicht sofort nach Beendigung der Verlegearbeiten, die verflieste Fläche ordnungsgemäß zu schützen. Waschen Sie die verflieste Fläche mit Säure um etwaigen Schmutz (wie z.B.: Schlieren vom Fugenmaterial, Zement, etc.) zu beseitigen.

Für die alltägliche Pflege empfehlen wir die Verwendung von handelsüblichen Reinigungsmitteln. Beachten Sie bitte die Verdünnungsanweisung des Herstellers des Produktes.

Die Pflege und die Reinigung der keramischen Platten ist sehr einfach und sollte mit neutralen Putzmitteln durchgeführt werden.

Bitte befolgen Sie die Herstellerangaben zum Gebrauch des Produktes. Schleifmittel können zur Beschädigung der Dekore führen und sind daher zu vermeiden.

Gold, Silver und Copper Stücke die durch die Ablagerung von Titanpartikeln - die ihnen einen metallischen Aspekt geben, verziert sind, sollten mit Vorsicht behandelt werden. Die Endreinigung und Wartung dieses Produkttyps sollte mit für Metalle geeigneten Reinigungsmitteln - Aufheller aus rostfreiem Stahl - durchgeführt werden, um eine antistatische Wirkung zu erzielen, die Schmutz abweisen und das Produkt vor Fetten und Korrosion schützen kann.

Die regelmäßige Reinigung des Produkts sollte mit einem mit Wasser oder Glasreiniger angefeuchteten Tuch erfolgen. Nach dem Trocknen sollte man die Flächen mit einem trockenen Tuch abwischen.

proteção e limpeza

Todos os resíduos de cola e argamassa de rejuntamento devem ser limpos da superfície das peças, imediatamente após a sua aplicação e de acordo com as instruções do fabricante.

Imediatamente após o assentamento do material cerâmico recomenda-se que as peças cerâmicas sejam devidamente protegidas. Para remoção de sujidade pós-obra, tais como resto de junta, cimentos, etc, recomenda-se a utilização de um ácido desincrustante tamponado para remoção de todos os resíduos.

Na manutenção diária poderão ser utilizados detergentes comuns, respeitando as diluições recomendadas pelo respetivo fabricante.

Relativamente às peças decoradas, dever-se-á evitar a utilização de produtos de limpeza abrasivos, que poderão danificar as peças.

As peças decoradas através da deposição de partículas de titânio - acabamento Gold, Silver e Copper - que lhe conferem um aspeto metálico deverão ser manuseadas com cuidado. A limpeza final e de manutenção deste tipo de produto deverá ser feita com detergentes próprios para metais - abrilhantador de aço inox - de forma a criar um efeito antiestático que possa repelir a sujidade e proteger o produto de gorduras e corrosão.

A limpeza regular do produto deverá ser feita com um pano humedecido em água ou limpa-vidros e após secagem deverá ser passado um pano seco.

index

colour map

collections

linea collections

useful information

calibers

certification

general sales

conditions

important notes

laying suggestions

margres green

margres tools

outdoor extra thick

package

Protect

sustainable choice

symbols

technical information



technical information

information technique . technische information . informação técnica

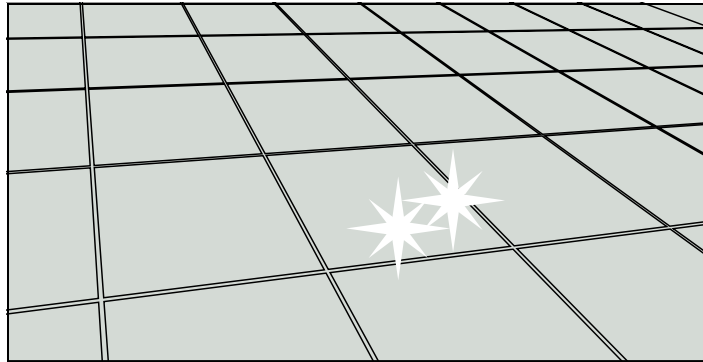

09

polished and soft shiny products

The parts of POLISHED and SOFT SHINY finishes series require specialized application and maintenance treatment.

The POLISHED and SOFT SHINY finishes are recommended, as well as for wall cladding, also for flooring in residential or light commercial areas that are not subjected to heavy traffic, where anti-slip characteristics are not required. The occasional presence of small inconsistencies or little spots on the surface is to be considered a characteristic of the material and of its unique production process. If the product is laid in direct contact with external environments, it is recommended to use protective solutions to reduce the formation of scratches.

Glue and Mortar

Preferably use mortars for grouting of color identical to the color of the product, and according to its specification - stoneware.

Application and first cleaning

When applying it, you should take the utmost care in removing the mortars used for grouting. Cleaning should be done while the mortars of the joints are still damp, with a cloth or a wet sponge, avoiding the use of abrasive detergents that could damage the pieces.

If the tiles have excess dry waterproofing material, the best way to remove it is by rubbing with paper or a clean and dry cloth. This cleaning can be carried out manually or using a suitable mono-spatula.

It is advisable to carry out this cleaning without any type of abrasive or contaminating materials.

Any cleaning with liquid products can potentiate the reduction of effectiveness of the repelling and protective treatment intended with the waterproofing application.

Maintenance

The final cleaning and maintenance of the product should be done with suitable detergents for floors.

High concentration detergent diluted according to the supplier's indication should be used, and depending on the degree of soiling it may be necessary to significantly reduce the dilution of the detergent and in some cases up to the proportion of 1/3 (detergent/water).

Rub with a microfiber cleaning cloth.

If the product is very dirty, we advise you to clean it manually.

In very exceptional cases where dirt is not removed with the method presented above, we recommend the use of a white polymer foam (1) used only with water.

(1) Commercially known as magic sponge

produits polis et adoucis

Les pièces des séries à finition POLI et ADOUCI nécessitent un traitement d'application et d'entretien spécialisé.

En plus des revêtements, la finition POLI et ADOUCI est également recommandée pour les sols dans les environnements résidentiels ou commerciaux légers peu soumis à des contraintes élevées, pour lesquels aucune prestation antidérapante n'est requise. La présence sporadique de petites irrégularités ou de points à la

surface doit être considérée comme une caractéristique du matériau et de sa fabrication particulière. Si le produit est placé en contact direct avec l'extérieur, il est conseillé d'utiliser des solutions de protection afin d'éviter la formation de rayures. Dans les zones à passage de charges lourdes concentrées, l'utilisation de produits d'épaisseur réduite n'est pas recommandée.

Colle et mortier

Utilisez des mortiers pour le jointoiment, de préférence de couleur identique à celle du produit, et selon les spécifications du produit - grès.

Application et premier nettoyage

Lors de son application, vous devez prendre le plus grand soin à enlever les mortiers utilisés pour le jointoiment. Le nettoyage doit être effectué alors que les mortiers du joint sont encore humides, avec un chiffon ou une éponge humide, en évitant l'utilisation de détergents abrasifs qui pourraient endommager les pièces.

Si les pièces ont un excédent sec d'imperméabilisant, la meilleure façon de l'enlever est de frotter avec un papier ou un chiffon propre et sec. Ce nettoyage peut être réalisé manuellement ou en utilisant une mono-spatule appropriée.

Il est conseillé d'effectuer ce nettoyage sans aucun type de matériaux abrasifs ou contaminants.

Un éventuel nettoyage avec des produits liquides peut réduire l'efficacité du traitement répulsif et protecteur escompté avec l'application d'imperméabilisation.

Entretien

Le nettoyage final et l'entretien du produit doivent être effectués avec des détergents adaptés aux sols.

Il est nécessaire d'utiliser des détergents à haute concentration dilués selon les instructions du fournisseur et, en fonction du degré de salissure, il peut être nécessaire de réduire considérablement la dilution du détergent et dans certains cas jusqu'à la proportion de 1/3 (détergent/eau). Frottez avec un chiffon de nettoyage en microfibre.

Si le produit est très sale, nous vous conseillons de le nettoyer manuellement.

Dans des cas très exceptionnels où la saleté n'est pas éliminée avec la méthode présentée ci-dessus, nous recommandons l'utilisation d'une mousse polymère blanche (1) utilisée uniquement avec de l'eau.

(1) Commercialement connue sous le nom d'éponge magique.

polierte und halbpoliert produkte

Die Serien Reihen mit POLIERTER und HALB POLIERTER Fertigstellung

erfordern eine spezielle Anwendung und Wartung.

Die POLIERTEN und HALBPOLIERTEN Oberflächen werden nicht nur für Wandverkleidungen empfohlen, sondern auch für Böden in Wohn- bzw. Gewerbebereichen, die keiner hohen Belastung ausgesetzt sind und bei denen keine rutschhemmende Wirkung erforderlich ist. Das sporadische Vorhandensein von kleinen Unebenheiten oder Punkten auf der Oberfläche ist als ein Merkmal von Material und besonderer Verarbeitung zu betrachten. Wird das Produkt in direkten Kontakt mit der Außenseite gebracht, wird empfohlen, Schutzlösungen zu verwenden, um die Bildung von Kratzern zu vermeiden. In Bereichen, die schwerer Belastung ausgesetzt sind, ist die Verwendung von Produkten mit reduzierter Stärke nicht empfehlenswert.

Klebstoff und Mörtel
Verwenden Sie Betumenmasse, vorzugsweise mit einer Farbe, die mit der Farbe des Produkts identisch ist, und gemäß der Produktspezifikation - Steinzeug.
Anwendung und erste Reinigung
Sie sollten beim Entfernen des zur Ausfugung verwendeten Mörtels vorsichtig vorgehen. Die Reinigung sollte durchgeführt werden, solange der Fugenmörtel noch feucht ist. Verwenden Sie dazu ein feuchtes Tuch oder einen Schwamm und vermeiden Sie kratzenden oder scheuernden Mittel, die die Teile beschädigen könnten.

Wenn die Teile einen trockenen Überschuss an Abdichtung aufweisen, entfernen Sie sie am besten mit einem sauberen, trockenen Papiertuch oder einem Stofftuch. Diese Reinigung kann entweder manuell oder mit einem geeigneten Spatel erfolgen.

Wir empfehlen, bei dieser Reinigung keine Schleifmittel oder kontaminierenden Materialien zu verwenden.
Wenn für die Reinigung flüssige Produkte verwendet werden, kann dies dazu führen, dass die gewünschte Wirksamkeit der abweisenden und schützenden

Behandlung mit der wasserfesten Anwendung verringert wird.
Wartung
Die finale Reinigung und Pflege des Produkts muss mit für Fußböden geeigneten Reinigungsmitteln erfolgen.
Es sollte ein hochkonzentriertes Reinigungsmittel verwendet werden, das gemäß den Anweisungen des Lieferanten verdünnt werden soll. Je nach Verschmutzungsgrad muss die Verdünnung des Waschmittels möglicherweise erheblich reduziert werden, in einigen Fällen mit einem Anteil von 1/3 (Reinigungsmittel / Wasser).
Mit einem Mikrofaser-Reinigungstuch einreiben.
Wenn das Produkt sehr schmutzig ist, empfehlen wir, es manuell zu reinigen.
In Ausnahmefällen, in denen mit der oben beschriebenen Methode der Schmutz nicht entfernt werden kann, empfehlen wir die Verwendung eines weißen Polymerschiums (1), der nur mit Wasser verwendet wird.

Behandlung mit der wasserfesten Anwendung verringert wird.

Wartung

Die finale Reinigung und Pflege des Produkts muss mit für Fußböden geeigneten Reinigungsmitteln erfolgen.

Es sollte ein hochkonzentriertes Reinigungsmittel verwendet werden, das gemäß den Anweisungen des Lieferanten verdünnt werden soll. Je nach Verschmutzungsgrad muss die Verdünnung des Waschmittels möglicherweise erheblich reduziert werden, in einigen Fällen mit einem Anteil von 1/3 (Reinigungsmittel / Wasser).

Mit einem Mikrofaser-Reinigungstuch einreiben.

Wenn das Produkt sehr schmutzig ist, empfehlen wir, es manuell zu reinigen.

In Ausnahmefällen, in denen mit der oben beschriebenen Methode der Schmutz nicht entfernt werden kann, empfehlen wir die Verwendung eines weißen Polymerschiums (1), der nur mit Wasser verwendet wird.

(1) Im Handel als magischer Schwamm bekannt.

produtos polidos e amaciados

As peças das séries de acabamento polido e amaciado exigem um tratamento de aplicação e de manutenção especializadas.

O acabamento POLIDO e AMACIADO, para além de ser aconselhado para revestimentos, é também indicado para pavimentos de ambientes residenciais ou comerciais de tráfego ligeiro, não sujeitos a elevada utilização, ou onde não sejam requeridas quaisquer prestações antiderrapantes. A presença esporádica de pequenas não uniformidades ou pontos na superfície deve ser considerada uma característica do material e do seu particular acabamento. Se o produto for colocado em contato direto com o exterior, recomenda-se o uso de soluções protetoras de modo a reduzir a possibilidade de formação de riscos. É da responsabilidade do instalador providenciar sempre a proteção das peças cerâmicas acabadas e limpas, antes da entrega ao cliente, utilizando materiais de proteção adequados (por ex. painéis de aglomerado, folhas de cartão, etc.).

Cola e Argamassa

Utilizar argamassas para betumação, de preferência de cor idêntica à cor do produto, e de acordo com a especificação do produto - grés.

Aplicação e primeira limpeza

Na sua aplicação deverá ter o máximo cuidado na remoção das argamassas utilizadas para rejuntar. A limpeza deve ser efetuada, enquanto as argamassas da junta ainda estiverem húmidas, com um pano ou esponja molhada, devendo-se evitar a utilização de detergentes abrasivos que poderão danificar as peças.

Caso as peças apresentem excesso seco de impermeabilizante, a melhor forma de o remover é, esfregando com papel ou pano limpo e seco, podendo essa limpeza ser realizada manualmente ou usando uma monoespátula apropriada.

Aconselhamos que esta limpeza seja realizada sem nenhum tipo de materiais abrasivos ou contaminantes.

Uma eventual limpeza com produtos líquidos pode ser potenciadora na diminuição da eficácia do tratamento repelente e protetivo pretendido com a aplicação impermeabilizante.

Manutenção

A limpeza final e de manutenção do produto deverá ser feito com detergentes próprios para pavimento.

Deverá ser usado detergente de alta concentração diluído conforme a indicação do fornecedor, e dependendo do grau de sujidade, a diluição do detergente poderá ter de ser bastante reduzida, podendo em alguns casos chegar à proporção de 1/3 (detergente/água).

Esfregar com um pano de limpeza de micro-fibra.

No caso de o produto apresentar muita sujidade, aconselhamos a que a limpeza seja feita manualmente.

Em casos muito excecionais da não remoção da sujidade com o método apresentado acima, recomendamos o uso de uma espuma polimérica branca(1) usada apenas com água.

(1) Comercialmente conhecida como esponja mágica.

technical information

information technique . technische information . informação técnica

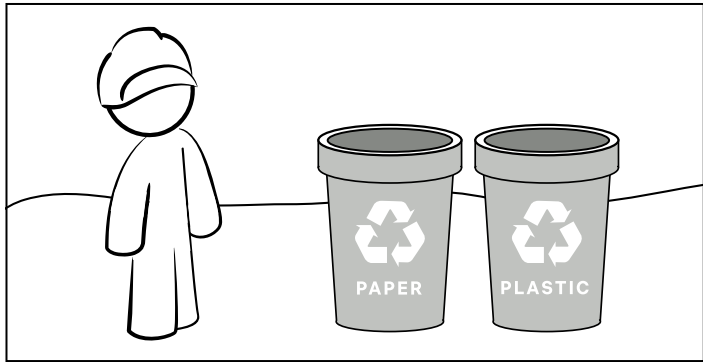

10

life cycle

The environmental impacts of our products are distributed through their life cycle complying extraction, raw materials transport, production, distribution, use and end of life.

Margres minimize these impacts through good practices of environmental management.

At the end of the product 's life cycle, Margres asks for your best management, favoring the reuse or recycling in a perspective of a circular economy.

cycle de vie

Les impacts environnementaux de nos produits sont distribués tout au long de leur cycle de vie, dans les phases d'extraction, de transport des matières premières, de production, de distribution, d'utilisation et de fin de vie. Chez Margres on minimise ces impacts environnementaux grâce aux bonnes pratiques de gestion de l'environnement.

Dans l'utilisation et la fin de vie, on appel à votre meilleure gestion en privilégiant la réutilisation ou le recyclage dans une perspective d'économie circulaire.

lebenszyklus

Die Umweltbelastung unserer Produkte prägt jede Phase ihres Lebenszyklus – die Gewinnung und das Transport der Rohstoffe, die Produktion, die Lieferung, der Gebrauch, die Entsorgung. Margres verniedlicht durch gute Programme des Umweltmanagements die Umweltbelastung.

In der Phase des Gebrauchs und der Entsorgung bitten wir Sie um eine bevorzugte Auswahl von Weiterverwenden oder Recycling.

ciclo de vida

Os impactes ambientais dos nossos produtos distribuem-se ao longo do seu ciclo de vida, nas etapas extração, transporte de matérias-primas, produção, distribuição, uso e fim de vida. A Margres minimiza estes impactes ambientais, através de boas práticas de gestão ambiental.

No uso e fim de vida, apelamos à vossa melhor gestão, privilegiando a reutilização ou a reciclagem numa perspectiva de economia circular.

index

colour map

collections

linea collections

useful information

calibers

certification

general sales

conditions

important notes

laying suggestions

margres green

margres tools

outdoor extra thick

package

Protect

sustainable choice

symbols

technical information



technical information

— information technique . technische information . informação técnica

technical features

données techniques . technischen eigenschaften . características técnicas

ISO 13006-Annex G (Grupo Bla UGL)
EN 14411-Annex G (Grupo Bla UGL)

technical features caractéristiques techniques technische eigenschaften características técnicas	test method méthode d'essai prüfmethode norma de ensaio	prescribed value valeur prescrite vorgeschriebener wert valor da norma ISO 13006 / EN 14411	typical value valeur typique typischer wert valor típico	MARGRES
size - length and width . dimension - longueur et largeur abmessungen - länge und breite . dimensão - comprimento e largura	ISO 10545 - 2	rectified ±0,3%, max. ± 1 mm not rectified ±0,6%, max. ± 2 mm	conform . conforme gemäß . conforme	
side straightness . rectitude des arêtes kantengeradheit . rectilinearidade das arestas		rectified ±0,3%, max. ± 0,8 mm not rectified ±0,5%, max. ± 1,5 mm	conform . conforme gemäß . conforme	
rectangularity . orthogonalité rechtwinkligkeit . ortogonalidade		rectified ±0,3%, max. ± 1,5 mm not rectified ±0,5%, max. ± 2 mm	conform . conforme gemäß . conforme	
warpage . planéité ebenflächigkeit . planaridade		rectified ±0,4%, max. ± 1,8 mm not rectified ±0,5%, max. ± 2 mm	conform . conforme gemäß . conforme	
thickness . épaisseur dicke . espessura		±5%, max. ± 0,5 mm	conform . conforme gemäß . conforme	
water absorption . absorption d'eau wasseraufnahme . absorção de água	ISO 10545-3	≤ 0,5%	conform . conforme gemäß . conforme	
modulus of rupture . module de rupture biegung modul . módulo de ruptura	ISO 10545 - 4	≥ 35N/mm ²	conform . conforme gemäß . conforme	
breaking strength (s) . résistance à la flexion (s) biegefestigkeit (s) . resistência à flexão (s)		≥ 1300 N	conform . conforme gemäß . conforme	
deep abrasion resistance . résistance à l'abrasion profonde widerstand gegen tiefenverschleiß . resistência à abrasão profunda	ISO 10545-6	≤ 175 mm ³	conform . conforme gemäß . conforme	
linear thermal expansion . dilatation thermique linéaire lineare wärmeausdehnung . dilatação térmica linear	ISO 10545-8	as indicated by manufacturer comme indiqué par le producteur wie vom hersteller angegeben conforme indicado pelo fabricante	conform . conforme gemäß . conforme	
thermal shock resistance . résistance au chocs thermique temperaturwechselbeständigkeit . resistência ao choque térmico	ISO 10545 - 9	required . nécessaire anforderung . exigida	resistant . résistant beständig . resistente	
frost resistance . résistance au gel frostbeständigkeit . resistência ao gelo	ISO 10545 - 12	required . nécessaire anforderung . exigida	resistant . résistant beständig . resistente	
chemical resistance . résistance à l'attaque chimique chemische beständigkeit . resistência ao ataque químico	ISO 10545 - 13	as indicated by manufacturer comme indiqué par le producteur wie vom hersteller angegeben conforme indicado pelo fabricante	resistant . résistant beständig . resistente	
stain resistance . résistance aux taches beständigkeit gegen fleckenbildner . resistência às manchas	ISO 10545 - 14	as indicated by manufacturer comme indiqué par le producteur wie vom hersteller angegeben conforme indicado pelo fabricante	resistant . résistant beständig . resistente	

It is guaranteed the compliance with the values required by norm EN 14411_Group Bla UGL. Typical Value is merely indicative, which can vary from real data, and does not have the purpose of any trading proposal.
Le respect de la norme EN14411_Group Bla UGL est garanti. La valeur typique annoncée étant indicative, pouvant varier de la valeur réelle, n'ayant pas la nature d'une proposition à caractère.
Es wird die Einhaltung der in der Norm EN 14411_Group Bla UGL geforderten Werte garantiert. Der angegebene Wert ist lediglich ein Richtwert, der von den tatsächlichen Daten abweichen kann und nicht Teil des Handelsvertrages darstellt.
É garantido o cumprimento da norma EN 14411_Group Bla UGL. O valor típico anunciado é meramente indicativo, podendo variar dos dados reais, não tendo a natureza de proposta negocial.

The technical characteristics stated in this catalogue do not invalidate the consultation of updated information on the website and technical data sheets.
Les caractéristiques techniques déclarées dans ce catalogue n'empêchent pas la consultation de l'information à jour dans le site web et fiches techniques.
Die in diesem Katalog angegebenen technischen Eigenschaften verzichtet nicht auf das Lesen der aktualisierten Informationen und der technischen Datenblätter auf der Website.
As características técnicas declaradas neste catálogo, não invalidam a consulta de informação atualizada no site e Fichas Técnicas.

MARGRES
CERAMIC TILES

technical information

information technique . technische information . informação técnica

technical features

données techniques . technischen eigenschaften . características técnicas

technical features caractéristiques techniques technische eigenschaften características técnicas	test method méthode d'essai prüfmethode norma de ensaio	prescribed value valeur prescrite vorgeschriebener wert valor da norma ISO 13006 / EN 14411	typical value valeur typique typischer wert valor típico	LINEA
size - length and width . dimension - longueur et largeur abmessungen - länge und breite . dimensão - comprimento e largura	ISO 10545 - 2	rectified ±0,3%, max. ± 1 mm not rectified ±0,6%, max. ± 2 mm	conform . conforme gemäß . conforme	
side straightness . rectitude des arêtes kantengeradheit . rectilinearidade das arestas		rectified ±0,3%, max. ± 0,8 mm not rectified ±0,5%, max. ± 1,5 mm	conform . conforme gemäß . conforme	
rectangularity . orthogonalité rechtwinkligkeit . ortogonalidade		rectified ±0,3%, max. ± 1,5 mm not rectified ±0,5%, max. ± 2 mm	conform . conforme gemäß . conforme	
warpage . planéité ebenflächigkeit . planaridade		rectified ±0,4%, max. ± 1,8 mm not rectified ±0,5%, max. ± 2 mm	conform . conforme gemäß . conforme	
thickness . épaisseur dicke . espessura		±5%, max. ± 0,5 mm	conform . conforme gemäß . conforme	
water absorption . absorption d'eau wasseraufnahme . absorção de água	ISO 10545-3	≤ 0,5%	conform . conforme gemäß . conforme	0,1% (*)
modulus of rupture . module de rupture biegung modul . módulo de ruptura	ISO 10545-4	≥ 35 N/mm ²	conform . conforme gemäß . conforme	50 N/mm ²
deep abrasion resistance . résistance à l'abrasion profonde beständigkeit gegen tiefenverschleiß . resistência à abrasão profunda	ISO 10545-6	≤ 175 mm ³	conform . conforme gemäß . conforme	conform . conforme gemäß . conforme
linear thermal expansion . dilatation thermique linéaire lineare wärmeausdehnung . dilatação térmica linear	ISO 10545-8	as indicated by manufacturer comme indiqué par le producteur wie vom hersteller angegeben conforme indicado pelo fabricante	conform . conforme gemäß . conforme	a ≤ 7x10 ⁻⁶ °C ⁻¹
frost-resistance . résistance au gel frostbeständigkeit . resistência ao gelo	ISO 10545-12	required . nécessaire anforderung . exigida	resistant . résistant beständig . resistente	LA - HA resistant . résistant beständig . resistente LB - HB polished . poli . poliert . polido smooth
chemical resistance . résistance à l'attaque chimique chemische beständigkeit . resistência ao ataque químico	ISO 10545 - 13	as indicated by manufacturer comme indiqué par le producteur wie vom hersteller angegeben conforme indicado pelo fabricante	resistant . résistant beständig . resistente	5 resistant . résistant beständig . resistente ≥ 3 polished . poli . poliert . polido smooth
stain resistance . résistance aux taches fleckenbeständigkeit . resistências às manchas	ISO 10545-14	as indicated by manufacturer comme indiqué par le producteur wie vom hersteller angegeben conforme indicado pelo fabricante	resistant . résistant beständig . resistente	Class A1 - 6mm Class A2-s1,dO - 5,5mm . 3,5mm (walls, mur, wand, revestimento) Class A1fl - 6mm Class A2fl-s1 - 5,5mm . 3,5mm (floor, sol, boden, pavimento)
fire reaction . réaction au feu brandverhalten . reação ao fogo	EN 13823 EN 9239-1	CPR (UE) 305/2011, 2000/147/E, UNI EN 13501-1	conform . conforme gemäß . conforme	
thermal conductivity . conductivité thermique wärmeleitfähigkeit . condutividade	EN 12524	-	conform . conforme gemäß . conforme	λ = 1,3 W/m °K λ = 0.7 BTU/ft h °F

(*) Average value referred to ceramic material only . Valeur moyenne se référant au matériau céramique . Durchschnittswert bezogen auf das Keramikmaterial . Valor médio refere-se apenas o material cerâmico.

It is guaranteed the compliance with the values required by norm EN 14411_Group Bla UGL. Typical Value is merely indicative, which can vary from real data, and does not have the purpose of any trading proposal.
Le respect de la norme EN14411_Group Bla UGL est garanti. La valeur typique annoncée étant indicative, pouvant varier de la valeur réelle, n'ayant pas la nature d'une proposition à caractère.
Es wird die Einhaltung der in der Norm EN 14411_Group Bla UGL geforderten Werte garantiert. Der angegebene Wert ist lediglich ein Richtwert, der von den tatsächlichen Daten abweichen kann und nicht Teil des Handelsvertrages darstellt.
É garantido o cumprimento da norma EN 14411_Group Bla UGL. O valor típico anunciado é meramente indicativo, podendo variar dos dados reais, não tendo a natureza de proposta negocial.

Linea is not intended for use in areas subject to the passage of heavy concentrated loads (for example, hard-wheeled trolleys).
Linea n'est pas conçu pour être utilisé dans des zones soumises au passage de charges lourdes et concentrées (par exemple, des chariots à roues rigides).
Linea ist nicht für den Einsatz in Bereichen bestimmt, in denen konzentrierte, schwere Lasten bewegt werden (z. B. Wagen mit harten Rädern).
Linea não é indicado para utilização em zonas sujeitas a passagem de cargas pesadas concentradas (por exemplo, carrinhos com rodas rígidas).

The technical characteristics stated in this catalogue do not invalidate the consultation of updated information on the website and technical data sheets.
Les caractéristiques techniques déclarées dans ce catalogue n'empêchent pas la consultation de l'information à jour dans le site web et fiches techniques.
Die in diesem Katalog angegebenen technischen Eigenschaften verzichtet nicht auf das Lesen der aktualisierten Informationen und der technischen Datenblätter auf der Website.
As características técnicas declaradas neste catálogo, não invalidam a consulta de informação atualizada no site e Fichas Técnicas.

index

colour map

collections

linea collections

useful information

calibers

certification

general sales

conditions

important notes

laying suggestions

margres green

margres tools

outdoor extra thick

package

Protect

sustainable choice

symbols

technical information



technical information

— information technique . technische information . informação técnica

slipping resistance

anti-slip

The application of material with anti-slip characteristics aims to reduce the risk of slipping on a surface used by pedestrians. Some of the test methods that allow the assessment of the degree of slippage are:

Annex A – Barefoot ramp test

Test used to assess damp surfaces where one usually walks barefoot (showers, swimming pools, changing rooms, etc.). The test is carried out on a tilting platform, where the material is continuously exposed to water. The operator walks barefoot back and forth on the test material, while the angle of inclination increases. When the safe walking limit is reached, the operator slips and the angle obtained is classified according to the table below.

Annex B – Shod foot ramp test

Test used to assess surfaces on which footwear is normally worn. The test is also carried out on the slip ramp, where the material is previously impregnated with oil. The operator walks back and forth on the test material with shoes on, while the inclination angle increases. When the safe walking limit is reached, the operator slips and the angle obtained is classified according to the table below.

Annex C – Pendulum test

The pendulum test is a method that measures the friction force between a sliding rubber and the test surface. After swinging the pendulum arm and the rubber coming into contact with the sample, there will be a reduction in movement and the test value will be represented on the graduated scale of the equipment. The pendulum test value is used to express the degree of slippage of the material under testing. The rubber to be used depends on whether we want to simulate the bare foot (rubber 57) or the shod foot (rubber 96) and the test can be carried out wet or dry. However, the most common test is with rubber 96 wet.

rutschfest

DieVerwendungvonMaterialienmitrutschfestenEigenschaftenzielt darauf ab,dieRutschgefahr auf einer von Personen benutzten Oberfläche zu verringern. Einige der Prüfmethode,n, die die Bewertung des Rutschgrads ermöglichen, sind:

Anhang A – Rampentest Barfuß

Test zur Bewertung von feuchten Oberflächen, auf denen man normalerweise barfuß läuft (Duschen, Schwimmbäder, Umkleieräume usw.). Der Test wird auf einer kippbaren Plattform durchgeführt, auf der das Material ständig Wasser ausgesetzt ist. Die Testperson läuft barfuß auf dem Prüfmaterial auf und ab, während der Neigungswinkel zunimmt. Wenn die sichere Grenze des Gehens erreicht ist, rutscht die Testperson aus und der gemessene Winkel wird gemäß der folgenden Tabelle klassifiziert.

Anhang B – Rampentest mit Schuhen

Test zur Bewertung von Oberflächen, auf denen normalerweise Schuhe getragen werden. Der Test wird ebenfalls auf der Rutschrampe durchgeführt, wobei das Material zuvor mit Öl imprägniert wird. Die Testperson läuft in Schuhen auf dem Prüfmaterial auf und ab, während der Neigungswinkel zunimmt. Wenn die sichere Grenze des Gehens erreicht ist, rutscht die Testperson aus und der gemessene Winkel wird gemäß der folgenden Tabelle klassifiziert.

Anhang C – Pendeltest

Der Pendeltest ist eine Methode zur Messung der Reibungskraft zwischen einem gleitenden Gummi und der Testoberfläche. Nach dem Schwingen des Pendelarms und dem Kontakt des Gummis mit der Probe kommt es zu einer Verringerung der Bewegung, und der Prüfwert wird auf der Skala des Geräts dargestellt. Der Pendelprüfwert wird verwendet, um den Grad des Gleitens des zu prüfenden Materials auszudrücken. Welcher Gummi verwendet wird, hängt davon ab, ob man einen nackten Fuß (Gummi 57) oder einen Schuh (Gummi 96) simulieren möchte. Der Test kann nass oder trocken durchgeführt werden. Der gebräuchlichste Test ist jedoch mit dem Gummi 96 und nass.

anexo A . annex A			anexo B . annex B					anexo C . annex C					
≥ 12°	≥ 18°	≥ 24°	≥ 6° - 10°	≥ 10° - 19°	≥ 19° - 27°	≥ 27° - 35°	≥ 35°	0 - 24	25 - 35	≥36			
A	B	C	R9	R10	R11	R12	R13						
→			→					→					
— +			— +					— +					
resistente ao escorregamento resistant to slippage résistant à la glissance rutschsicherheit			resistente ao escorregamento resistant to slippage résistant à la glissance rutschsicherheit					alto risco de escorregamento high slip potential haut risque de glissance hohe rutschgefahr			baixo risco de escorregamento low slip potential bas risque de glissance geringe rutschgefahr		

antidérapant

La pose de matériaux aux caractéristiques antidérapantes vise à réduire le risque de glissement sur une surface utilisée par les piétons. Voici certains des méthodes d’essai permettant d’évaluer le degré de glissement :

Annexe A – Test de la rampe pieds nus

Test utilisé pour évaluer les surfaces humides où l'on marche habituellement pieds nus (douches, piscines, vestiaires, etc.). Le test est réalisé sur une plateforme inclinable, où le matériel est continuellement exposé à l'eau. L'opérateur marche pieds nus d'avant en arrière sur le matériel d'essai, tandis que l'angle d'inclinaison augmente. Lorsque la limite de sécurité de la marche est atteinte, l'opérateur glisse et l'angle obtenu est classé selon le tableau ci-dessous.

Annexe B – Test de la rampe chaussé

Test utilisé pour évaluer les surfaces où l'on marche habituellement chaussé. Le test est également réalisé sur la rampe de glissement, où le matériel est imprégné d'huile. L'opérateur marche chaussé d'avant en arrière sur le matériel d'essai, tandis que l'angle d'inclinaison augmente. Lorsque la limite de sécurité de la marche est atteinte, l'opérateur glisse et l'angle obtenu est classé selon le tableau ci-dessous.

Annexe C – Test du pendule

Le test du pendule est une méthode qui mesure la force de friction entre un caoutchouc glissant et la surface d'essai. Après avoir balancé le bras du pendule et que le caoutchouc entre en contact avec l'échantillon, il y aura une réduction du mouvement, et la valeur du test sera représentée sur l'échelle graduée de l'équipement. La valeur du test du pendule est utilisée pour exprimer le degré de glissement du matériel en test. Le caoutchouc à utiliser dépend si l'on veut simuler le pied nu (caoutchouc 57) ou le pied chaussé (caoutchouc 96) et le test peut être réalisé à humide ou à sec. Cependant, le test le plus habituel est avec le caoutchouc 96 à humide.

antiderrapante

A aplicação de material com características antiderrapantes tem como objetivo reduzir o risco de escorregamento numa superfície utilizada por pedestres. Alguns dos métodos de ensaio que permitem a avaliação do grau de escorregamento são:

Anexo A – Teste da rampa descalço

Teste utilizado para avaliar superfícies húmidas onde se circula habitualmente com pés descalços (duches, piscinas, balneários, etc). O teste é realizado numa plataforma inclinável, onde o material é continuamente exposto a água. O operador caminha descalço para a frente e para trás sobre o material de teste, enquanto o ângulo de inclinação vai aumentando. Quando o limite seguro da caminhada é atingido, ocorre o escorregamento do operador e o ângulo obtido é classificado conforme a tabela abaixo.

Anexo B – Teste da rampa calçado

Teste utilizado para avaliar superfícies onde se circula habitualmente com pés calçados. O teste é realizado também na rampa de escorregamento, onde o material é previamente impregnado com óleo. O operador caminha calçado para a frente e para trás sobre o material de teste, enquanto o ângulo de inclinação vai aumentando. Quando o limite seguro da caminhada é atingido, ocorre o escorregamento do operador e o ângulo obtido é classificado conforme a tabela abaixo.

Anexo C – Teste do pêndulo

O teste do pêndulo é um método que mede a força de atrito entre uma borracha deslizante e a superfície de teste. Após balançar o braço do pêndulo e a borracha entrar em contacto com a amostra, vai existir redução do movimento, e o valor do teste ficará representado na escala graduada do equipamento. O valor do teste do pêndulo é utilizado para expressar o grau de deslizamento do material em teste. A borracha a utilizar depende se queremos simular o pé descalço (borracha 57) ou o pé calçado (borracha 96) e o teste pode ser realizado a húmido ou a seco. No entanto, o teste mais habitual é com a borracha 96 a húmido.

V

shade variation

denuançage . farbspiel . destonalização

ANSI A137.1

ANSI A137.1

Tiles may vary in color, texture, or appearance according to the manufacturer’s design for that particular tile series or product line. The following aesthetic class designations have been provided in the Table, so that the manufacturer may communicate the aesthetic characteristics of a particular tile product.

La couleur, la structure et l’aspect des carreaux peuvent varier en fonction des spécifications du producteur définies pour la série de carreaux ou la ligne de produit spécifique. Les désignations de « classe esthétique » suivantes sont fournies dans le Tableau pour permettre au producteur de communiquer les caractéristiques esthétiques d’un produit particulier.

Die Farbe, die Struktur und das Aussehen der Fliesen können auf Grund der für die besondere Fliesenserie oder Produktreihe festgelegten Spezifikationen des Herstellers variieren. Die folgenden Bestimmungen der „ästhetischen Kategorie“ finden sich in Tabelle, damit der Hersteller die ästhetischen Charakteristiken eines besonderen Produkts mitteilen kann.

Os mosaicos podem variar em cor, textura ou aspeto conforme o desenho do fabricante para essa série de mosaicos ou linha de produtos em particular. As seguintes designações de classe estética foram colocadas na Tabela para que o fabricante possa comunicar as características estéticas de determinado produto de mosaico.

V0	V1	V2	V3	V4
None	Minor	Low	Medium	Major
Nul	Léger	Faible	Moyen	Élevé
Gleich Null	Leicht	Gering	Mittelmäßig	Stark
Nulo	Ligeiro	Baixo	Médio	Alto

V0	V1	V2	V3	V4
None	Minor	Low	Medium	Major
Nul	Léger	Faible	Moyen	Élevé
Gleich Null	Leicht	Gering	Mittelmäßig	Stark
Nulo	Ligeiro	Baixo	Médio	Alto

Very uniform appearance. Pieces of the same shade value are very uniform.	Uniform appearance. Differences among pieces from the same production run are minimal.	Slight variation. Clearly distinguishable differences in texture and/or pattern within similar colors.	Moderate variation. While the colors and or texture present on a single piece of tile will be indicative of the colors and or texture to be expected on the other tiles, the amount of colors and or texture on each piece may vary significantly. It is recommended that the range be viewed before selection.	Substantial variation. Random color and or texture differences from tile to tile, so that one tile may have totally different colors and or texture from that on other tiles. Thus, the final installation will be unique. It is recommended that the range be viewed before selection.
--	---	---	--	--

Aspect très uniforme. Les pièces de la même variante de couleur sont très uniformes.	Aspect uniforme. Les différences entre les pièces d'un même lot de production sont minimes.	Variations minimes. Différences clairement visibles au niveau de la structure et/ ou du design entre les pièces caractérisées par des couleurs analogues.	Variations modérées. Même si les couleurs et la structure d'une seule pièce peuvent identifier les couleurs et les structures des autres pièces, la variation de la couleur et de la structure de chaque pièce peut être significative. Il est conseillé d'examiner la gamme avant de choisir.	Variations importantes. Différences casuelles au niveau de la couleur ou de la structure d'un carreau à l'autre. Un carreau peut ainsi présenter des couleurs et/ou une structure totalement différentes de celles d'autres carreaux. Le résultat final sera donc unique et non reproductible. Il est conseillé d'examiner la gamme avant de choisir.
---	--	--	---	--

Sehr gleichmäßiges Aussehen. Die Teile der gleichen Farbvariante sind sehr gleichmäßig.	Gleichmäßiges Aussehen. Die Unterschiede zwischen den Teilen eines Produktionsloses sind minimal.	Leichte Variationen. Klar erkennbare Unterschiede in Texturen und/oder Muster mit ähnlichen Farben.	Ligeira variação. É possível distinguir diferenças claramente na textura e/ou padrão com cores semelhantes.
--	--	--	--

Aspetto muito uniforme. Peças com o mesmo valor de tonalidade são muito uniformes.	Aspetto uniforme. As diferenças entre as peças da mesma fase de produção são mínimas.
---	--

technical information

information technique . technische information . informação técnica

index

colour map

collections

linea collections

useful information

calibers

certification

general sales

conditions

important notes

laying suggestions

margres green

margres tools

outdoor extra thick

package

Protect

sustainable choice

symbols

technical information

technical information

technical information



package

— emballage . verpackung . embalagem

calibers

— calibres . kaliber . calibres —

size format formato formato (cm)	thickness épaisseur stärke espesura	box . boîte . karton . caixa			pallet . palette . palette . paleta			pallet dimension . dimensions des palettes paletten abmessungen . dimensões paletes		
		pieces pièces stück peças	sqm m ²	weight poids gewicht peso (kg)	boxes boîtes kartonen caixas	sqm m ²	weight poids gewicht peso (kg)	width largeur breite largura (cm)	length longueur laenge comprimento (cm)	height hauteur höhe altura (cm)
120x120	9,0 mm	1	1,44	31,80	32	46,08	1037,60	130	130	61
	9,0 mm	2	2,88	62,00	20	57,60	1260,00	124	143	64
90x90	9,5 mm	2	1,62	36,20	25	40,50	925,00	94	107	84
	10,5 mm	2	1,62	40,00	25	40,50	1020,00	94	107	84
	11,0 mm	2	1,62	41,90	25	40,50	1067,50	94	107	84
	20,0 mm	1	0,81	37,30	30	24,30	1139,00	94	107	83
89x89	9,5 mm	2	1,58	35,10	25	39,50	897,50	94	107	105
88x88	9,5 mm	2	1,55	33,60	25	38,75	860,00	94	107	105
60x120	9,5 mm	2	1,44	32,30	36	51,84	1182,80	94	122	75
	9,5 mm Stage	2	1,44	30,00	36	51,84	1100,00	94	122	75
	10,5 mm	2	1,44	35,60	30	43,20	1088,00	94	122	75
	11,0 mm	2	1,44	37,30	30	43,20	1139,00	94	122	75
60x90	20,0 mm	1	0,72	32,50	32	23,00	1060,00	94	122	85
	20,0 mm	1	0,54	23,69	40	21,60	968,00	93	125	75
60x60	8,5 mm	4	1,44	28,80	30	43,20	884,00	80	120	75
	9,5 mm	3	1,08	24,10	40	43,20	984,00	80	120	75
	10,0 mm	3	1,08	25,40	40	43,20	1036,00	80	120	75
	14,0 mm	2	0,72	23,70	40	28,80	968,00	80	120	75
45x90	20,0 mm	2	0,96	42,40	24	23,04	1037,60	84	125	55
	9,0 mm	4	1,62	34,30	24	38,88	843,20	100	120	60
40x120	20,0 mm	2	0,96	42,40	24	23,04	1037,60	84	125	55
30x60	8,5 mm	6	1,08	21,60	48	51,84	1056,80	80	120	75
	9,5 mm	5	0,90	20,10	48	43,20	984,80	80	120	75
	10,0 mm	5	0,90	21,20	48	43,20	1037,60	80	120	75
30x30	8,5 mm	16	1,44	28,80	40	57,60	1172,00	80	120	75
	12,0 mm	12	1,08	30,50	40	43,20	1240,00	80	120	75
20x120	8,0 mm	7	1,68	31,00	24	40,32	764,00	84	125	50
	9,0 mm	7	1,68	32,90	24	40,32	809,60	84	125	55
	9,5 mm	6	1,44	30,00	24	34,56	740,00	84	125	55

LIN3A

size format formato formato (cm)	thickness épaisseur stärke espesura	box . boîte . karton . caixa			pallet . palette . palette . paleta			pallet dimension . dimensions des palettes paletten abmessungen . dimensões paletes		
		pieces pièces stück peças	sqm m ²	weight poids gewicht peso (kg)	boxes boîtes kartonen caixas	sqm m ²	weight poids gewicht peso (kg)	width largeur breite largura (cm)	length longueur laenge comprimento (cm)	height hauteur höhe altura (cm)
120x278	6,0 mm	1	3,34	47,00	18	60,05	916,00	140	290	28
120x260	6,0 mm	1	3,12	44,00	18	56,16	845,80	136	275	28
120x120	6,0 mm	2	2,88	40,60	24	69,12	975,20	130	130	58
	3,5 mm	1	3,00	23,40	20	60,00	538,00	111	320	23
100x300	5,5 mm	1	3,00	37,00	13	39,00	518,50	111	320	23
	6,0 mm	1	3,00	41,40	13	39,00	608,20	111	320	23
100x250	5,5 mm	1	2,50	28,75	13	32,50	443,75	111	264	23
	6,0 mm	1	2,50	34,50	13	32,50	518,50	111	264	23
100x100	3,5 mm	3	3,00	23,40	25	75,00	605,00	111	111	64
	5,5 mm	2	2,00	25,40	25	50,00	595,00	111	111	64
	6,0 mm	2	2,00	27,60	25	50,00	710,00	111	111	64
60x120	6,0 mm	3	2,16	30,25	16	34,56	504,80	130	130	58

The featured weights are approximate. The quantities of Sqm (m²)/pieces per box/palette may exceptionally vary and shall be confirmed by Margres.
 Les poids présentés sont approximatifs. Les quantités m²/pièces par boîte/palette peuvent exceptionnellement varier. Nous vous prions donc de bien vouloir confirmer auprès de Margres.
 Die angegebenen Gewichte sind Näherungswerte. Die Mengen, m²/Stücke pro Verpackung/Palette können in Einzelfällen abweichen. Sie sollten also von Margres bestätigt werden.
 Os pesos apresentados são aproximados. As quantidades m²/peças por caixa/paleta podem excepcionalmente variar, pelo que agradecemos a confirmação junto da Margres.

non rectified

non rectifié . nicht rektifiziert . não retificado

size format formato formato (cm)	thickness épaisseur stärke espesura	A	B	C	D	E	H	L
30x30	8,5 mm	296,1 x 296,1	297,4 x 297,4	298,7 x 298,7	300,0 x 300,0	301,3 x 301,3	302,6 x 302,6	303,9 x 303,9
	12,0 mm	296,1 x 296,1	297,4 x 297,4	298,7 x 298,7	300,0 x 300,0	301,3 x 301,3	302,6 x 302,6	303,9 x 303,9
20x120	8,0 mm	202,5 x 1200,1	203,0 x 1201,4	203,5 x 1202,7	204,0 x 1204,0	204,5 x 1205,0	-	-
	9,0 mm	202,5 x 1200,1	203,0 x 1201,4	203,5 x 1202,7	204,0 x 1204,0	204,5 x 1205,0	-	-

rectified

rectifié . rektifiziert . retificado

size format formato formato (cm)	thickness épaisseur stärke espesura	S*	Q	P	N
120x120	9mm	-	1194,0 x 1194,0	1198,0 x 1198,0	1202,0 x 1202,0
	9,5 mm	-	895,0 x 895,0	898,0 x 898,0	901,0 x 901,0
90x90	10,5 mm	-	895,0 x 895,0	898,0 x 898,0	901,0 x 901,0
	11,0 mm	-	895,0 x 895,0	898,0 x 898,0	901,0 x 901,0
	20,0 mm	-	895,0 x 895,0	898,0 x 898,0	901,0 x 901,0
89x89	9,5 mm	890,0 x 890,0	-	-	-
60x120	9,5 mm	596,5 x 1195,0	596,5 x 1195,0	598,0 x 1198,0	600,0 x 1202,0
	10,5 mm	-	596,5 x 1195,0	598,0 x 1198,0	600,0 x 1202,0
	11,0 mm	-	596,5 x 1195,0	598,0 x 1198,0	600,0 x 1202,0
	20,0 mm	-	596,5 x 1195,0	598,0 x 1198,0	600,0 x 1202,0
60x90	20,0 mm	-	596,0 x 895,0	598,0 x 898,0	600,0 x 901,0
	8,5 mm	596,5 x 596,5	596,0 x 596,0	598,0 x 598,0	600,0 x 600,0
60x60	9,5 mm	-	596,0 x 596,0	598,0 x 598,0	600,0 x 600,0
	10,0 mm	-	596,0 x 596,0	598,0 x 598,0	600,0 x 600,0
	14,0 mm	-	596,0 x 596,0	598,0 x 598,0	600,0 x 600,0
	20,0 mm	-	596,0 x 596,0	598,0 x 598,0	600,0 x 600,0
45x90	9,0 mm	-	446,5 x 895,0	448,0 x 898,0	449,5 x 901,0
40x120	20,0 mm	-	397,0 x 1195,0	398,0 x 1198,0	399,3 x 1201,0
30x60	8,5 mm	-	297,0 x 596,0	298,0 x 598,0	299,0 x 600,0
	9,5 mm	-	297,0 x 596,0	298,0 x 598,0	299,0 x 600,0
	10,0 mm	-	297,0 x 596,0	298,0 x 598,0	299,0 x 600,0
20x120	9,5 mm	-	197,0 x 1195,0	198,0 x 1198,0	198,7 x 1202,0

* Endless and Prestige collections in polished finish . Collections Endless et Prestige en finition polie . Die Kollektionen Endless und Prestige in polierter Fertigung . Coleções Endless e Prestige no acabamento polido

LIN3A

size format formato formato (cm)	thickness épaisseur stärke espesura	3plus
100x300	3,5 mm	1000,0 x 3000,0
100x100	3,5 mm	1000,0 x 1000,0

size format formato formato (cm)	thickness épaisseur stärke espesura	5plus
100x300	5,5 mm	997,0 x 3000,0
100x250	5,5 mm	997,0 x 2500,0
100x100	5,5 mm	997,0 x 997,0

size format formato formato (cm)	thickness épaisseur stärke espesura	6mm
120x278	6,0 mm	1198,0 x 2780,0
120x260	6,0 mm	1198,0 x 2600,0
120x120	6,0 mm	1198,0 x 1198,0
100x300	6,0 mm	997,0 x 3000,0
100x250	6,0 mm	997,0 x 2500,0
100x100	6,0 mm	997,0 x 997,0
60x120	6,0 mm	598,0 x 1198,0

index

colour map

collections

linea collections

useful information

calibers

certification

general sales

conditions

important notes

laying suggestions

margres green

margres tools

outdoor extra thick

package

Protect

sustainable choice

symbols

technical information



symbols

— symbologie . zeichen . simbologia

FULL BODY PORCELAIN

Full Body Porcelain
Grès Cérame Pleine Masse
Durchgefärbtes Feinsteinzeug
Grés Porcelânico Toda a Massa

DIGITEK PORCELAIN STONEWARE

Fully digital graphics
Graphisme totalement digital
Komplett digitale Grafik
Produto com gráfica totalmente digital

LAMINATED PORCELAIN STONEWARE

Reduced thickness porcelain tile
Grès cérame fine épaisseur
Feinsteinzeug mit geringerer Dicke
Grés Porcelânico de baixa espessura

TECHNICAL FULL BODY PORCELAIN

Technical Full Body Porcelain
Grès Cérame Pleine Masse Technique
Technishes, Durchgefärbtes Feinsteinzeug
Grés Porcelânico Toda a Massa Técnico

UGL

Unglazed
Non émaillé
Unglasierte
Não esmaltado

M²

Decors sold per Sqm (m²)
Décorations vendues au m²
Dekorationen verkauftpro m²
Decorações vendidas a m²



Low traffic
Faible passage
Leicht Frequentiert
Baixo tráfego



Medium traffic
Passage modéré à élevé
Mittlere Frequentierung
Médio tráfego



Medium high traffic
Passage modéré à élevé
Mittlere bis starke Frequentierung
Médio alto tráfego



High traffic
Fort Passage
Starke Frequentierung
Alto tráfego

3D TOUCH

With 3D Touch, it is possible to faithfully reproduce natural textures, the grain and texture of wood, explore graphic effects or create visual dynamics.
Avec le 3D Touch, il est possible de reproduire fidèlement des textures naturelles, le grain et la texture du bois, d'explorer des effets graphiques ou de créer des dynamiques visuelles.
Mit 3D Touch ist es möglich, natürliche Texturen, die Körnung und die Textur des Holzes originalgetreu wiederzugeben, grafische Effekte zu erkunden oder visuelle Dynamik zu erzeugen.
Com o 3D Touch, é possível reproduzir fielmente texturas naturais, o grão e a textura da madeira, explorar efeitos gráficos ou criar dinâmicas visuais.

PROTECT

Antibacterial for Life.

An exclusive line of extremely high performance antimicrobial floor and wall tiles, designed for healthy, safe and protected living spaces. Anti-slip finish doesn't have antibacterial protection
Une ligne exclusive de sols et revêtements antibactériens aux performances très élevées, pour un habitat sain, sûr et protégé. La finition antidérapante n'a pas de protection antibactérienne.
Eine exklusive Linie an hochwertigen Fußböden und antibakteriellen Wandverkleidungen, für ein gesundes, sicheres und geschütztes Leben. Die rutschfeste Oberfläche hat keinen antibakteriellen Schutz.
Uma linha exclusiva de pavimentos e revestimentos antimicrobianos de altíssima performance, projetada para ambientes saudáveis, seguros e protegidos. O acabamento antiderrapante não tem proteção antibacteriana.

BIM

The Margres BIM library brings together on a single platform, all the digital information necessary for the development of architectural projects.
La bibliothèque BIM de Margres rassemble, sur une seule plateforme, toutes les informations numériques nécessaires au développement de projets architecturaux.
Die BIM-Bibliothek von Margres sammelt auf einer einzigen Plattform alle digitalen Informationen, die für die Entwicklung von Architekturprojekten erforderlich sind.
A biblioteca BIM da Margres reúne, numa única plataforma, toda a informação digital necessária para o desenvolvimento de projetos de arquitetura.

MARGRES
CERAMIC TILES

size reading

— lire le format . leseformat . leitura do formato

size format formato formato (cm)	reference référence referenz referência
120x278	1228
120x260	1226
120x120	1212
100x300	1030
100x250	1025
100x100	1010
90x90	99
89x89	99

size format formato formato (cm)	reference référence referenz referência
60x120	62
60x90	69
60x60	66
45x90	49
40x120	412
30x60	36
30x30	33
20x120	212

size format formato formato (cm)	reference référence referenz referência
9,5x90	109
9,5x30	13
8x120	812
8x90	89
8x88	89
8x60	86

examples

exemples . beispiele . exemplos

36 CT1 NR

size: **36**
colour: **CT1**
surface: **NR**

66 T21 P

size: **66**
colour: **T21**
surface: **P**

laying suggestions

— suggestions de pose . anwendungsvorschläge . sugestões de aplicação

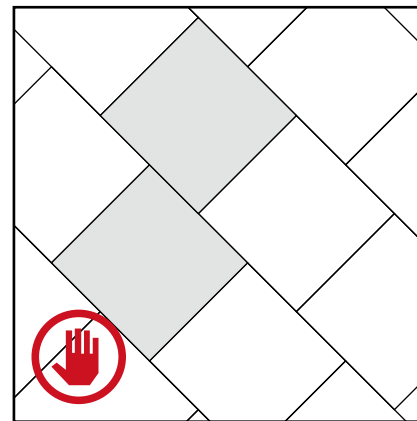
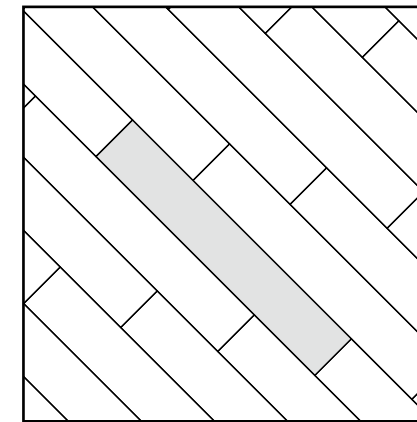
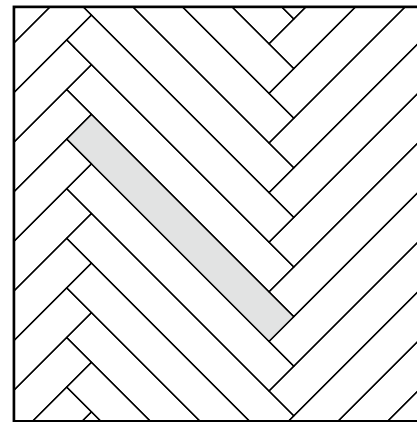

Not recommended
Non recommandé
Nicht empfohlen
Não recomendado

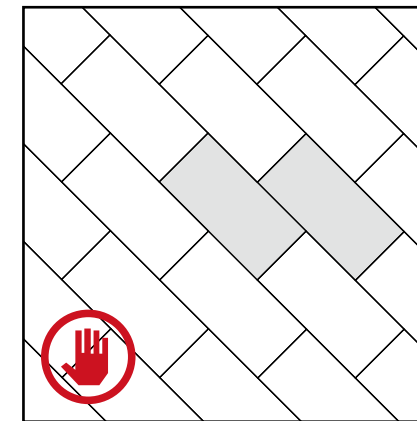

Not recommended
Non recommandé
Nicht empfohlen
Não recomendado

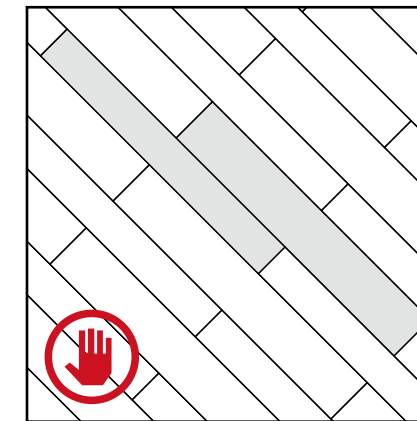

Not recommended
Non recommandé
Nicht empfohlen
Não recomendado



general sales conditions

1 - Applicability of Conditions

1.1. The general conditions listed and specified below - hereinafter referred to as the "CONDITIONS" - form an integral part of the contract for the purchase and sale of mosaics and other ceramic products - hereinafter referred to as the "PRODUCT" or the "PRODUCTS" - manufactured by Margres - Gres Panaria Portugal, S.A., also referred to as the "MANUFACTURER".

1.2. Except in specific or exceptional cases, in which the application of these conditions is expressly modified by written agreement and signed by the MANUFACTURER, they represent the exclusive conditions applied to such sale. If one or more parts of these CONDITIONS or contracts, individually considered and of which they form part, are in any way deemed null and void, invalid or unenforceable by reason of force majeure, the general or particular CONDITIONS shall remain valid as a whole and the invalid conditions shall be replaced by new provisions reproducing, as far as possible, the original intention of the parties.

1.3. Sales made by our company are governed by the United Nations Convention on Contracts for the International Sale of Goods (CISG — Vienna, 1980). The parties agree that all matters relating to the formation of the contract, its performance, non-conformity, warranties, liabilities, and the parties' rights shall be interpreted in accordance with the CISG. The buyer undertakes to examine the goods and to notify any lack of conformity within the time limits set out in Articles 38 and 39 of the Convention, unless otherwise contractually agreed.

2 - Execution of the Sales Contract - Delivery of Products

2.1. The contract shall be signed when the proposing party or the purchaser becomes aware of its written acceptance by the counterpart.

2.2. An order that has not been confirmed in writing cannot under any circumstances be considered as accepted, unless it has been executed by the MANUFACTURER through the shipment or delivery of the PRODUCTS. The partial delivery of the ordered PRODUCTS does not imply acceptance of the entire order, but only of the part concerning the PRODUCTS that have actually been delivered.

2.3. Unless previously and expressly otherwise agreed, the delivery of the PRODUCTS will exclusively be made in the territory of mainland Portugal and on the condition that it is possible and allowed access of heavy vehicles with semi-trailers of 24 (twenty-four) tons of gross weight to the place of delivery.

2.4. Unless otherwise expressly agreed, all dates indicated for delivery purposes shall be considered as approximate dates.

3 - Product Characteristics - Guarantee - Complaints

3.1. The PRODUCTS manufactured by Margres - Gres Panaria Portugal, S.A., are produced in accordance with the applicable European standards. The MANUFACTURER preferably sells to professional resellers, who are responsible for providing correct and appropriate technical information to end users or retailers.

The classification of the PRODUCTS is indicated by the MANUFACTURER in advertising material and/or price lists. Consequently, the buyer must use the PRODUCTS in accordance with the MANUFACTURER's specifications.

To facilitate the suggestion of use and adapt the standard specification to the specific production of the MANUFACTURER, all products, price lists or catalogues contain specific symbols indicating the recommended use for each product by the MANUFACTURER.

3.2. Differences in tonality or chrominance, if any, do not result from defects in the PRODUCT, rather being a specific characteristic of the ceramic material that has been subjected to firing at high temperatures. The special characteristic of "freezing resistance" only applies to products which the MANUFACTURER has specifically guaranteed for that purpose by means of express indication in its advertising material and/or price lists. In case of absence of this indication , the products will be solely and exclusively considered for indoor use or, in any case, for use in places that are not exposed to atmospheric elements that alter the resistance characteristics or the original look of the PRODUCT (e.g. atmospheric precipitation, sun, humidity, low temperatures, etc.).

3.3. Mosaics with polished faces may change their appearance when used on the floor of rooms that have access from the outside, or rooms where intense pedestrian traffic is expected. Polished tiles can also be slippery, especially when wet or damp. For this reason, the MANUFACTURER advises against the use of these PRODUCTS in public places. For places where people circulate intensively, the buyer should only purchase PRODUCTS classified by the MANUFACTURER as "PEI V" or "Full Body Porcelain Stoneware", in particular those PRODUCTS that the MANUFACTURER specifically recommends for use in public places.

3.4. The presentations of the PRODUCTS in leaflets or in any other promotional material by the MANUFACTURER are merely illustrative and do not necessarily represent the aesthetic end-result arising from the installation of that specific product.

3.5. The MANUFACTURER guarantees the good quality and the absence of defects in the PRODUCTS supplied.

The guarantee does not apply to PRODUCTS classified by the MANUFACTURER as inferior to the 1st. choice quality, or to the stocks of products that have been discontinued, when they are sold in bulk or indicated as special lot.

3.6. The MANUFACTURER shall not be liable for any defects and/or anomalies existing in the PRODUCTS that do not result from their technical specifications but rather arise from the improper use of the PRODUCTS by the purchasers and/or third parties acting on their behalf. In particular, the MANUFACTURER does not accept any complaints or disputes related to the above described situations.

3.7. Complaints arising from the existence of evident or hidden defects must be made to the MANUFACTURER in writing by the purchaser within 60 days from the date of delivery of the goods. The Manufacturer's liability for defects inherent in the products delivered to the Buyer is expressly limited to 2 years from the date of receipt of the goods by the Buyer.

3.8. In general, the guarantee only applies to defects found in products which have not yet been applied. For defects detected after the PRODUCTS have been applied, the guarantee can only apply if the MANUFACTURER has confirmed that the installation of the PRODUCT has been carried out in accordance with the best rules of the activity (DIN 18352), as well as in accordance with the procedures described in the MANUFACTURER's application and maintenance manual.

3.9. The guarantee granted by the MANUFACTURER is limited to the replacement of the defective products with other products of the same type without defect, plus transport costs. The reimbursement of any other costs and/or expenses, in particular demolition and relocation costs, is expressly excluded. In any case, the MANUFACTURER's guarantee does not exceed five times the value of the material claimed, up to a maximum of 10,000 Euros.

3.10. The MANUFACTURER is not responsible for any claims due to a classification of ceramic materials made by certification and control bodies other than the European ones, indicated in article 3.1, based on technical specifications that do not correspond to those indicated by the MANUFACTURER. Any specialised technical analysis requested by the buyer will be based on the correspondence of the materials sold with the technical characteristics indicated by the MANUFACTURER, at that time in force in Portugal.

4 - Prices and Payment Conditions

4.1. The sale prices of the PRODUCTS are those indicated in the MANUFACTURER's price list in force on the date of confirmation of order. For sales contracts with separate deliveries, the price shall be the one set out in the price list in force on the date of each delivery, unless the contracting parties have stipulated differently.

For PRODUCTS aimed at foreign markets the price will be calculated, by indication of the MANUFACTURER, in the foreign currency of the country of destination or in Euros.

4.2. Unless otherwise expressly agreed, payments shall be made by bank transfer within 30 days from the date of invoice. All bank and transfer charges shall be borne by the purchaser. In the event of delay in making payment, the MANUFACTURER shall be entitled, without prior notice to the buyer, to apply a late payment and penalty interest rate equivalent to the 6-month EURIBOR rate plus 5%, without prejudice to the right to compensation for any other losses.

5 - Manufacturer's Agents

5.1. The MANUFACTURER's agents promote the sale of the PRODUCTS and are not authorised to act in the name and on behalf of the MANUFACTURER, unless they obtain express specific authorisation to do so.

5.2. Orders received by agents are not binding on the MANUFACTURER and must therefore be expressly accepted in writing by the MANUFACTURER itself.

6 - Ownership Reservation

6.1. It is agreed between the parties that the sale of the PRODUCTS shall be made with ownership reservation by the MANUFACTURER until full payment of the agreed price is entirely made by the purchaser. However, the risk of loss of the goods is transferred to the purchaser upon delivery of the PRODUCTS.

6.2. In case of sales to foreign countries, when the goods are sold and delivered to third parties within the framework of the Buyer's normal business activities and the ownership of the goods has not yet been transferred, the MANUFACTURER's ownership reservation remains valid vis-à-vis third parties.

6.3. In the event of delays in payment the MANUFACTURER has the right, without the need for any formality including any prior notice to the purchaser, to collect all goods subject to ownership reservation and if legally enshrined, all credit titles to third parties, and the MANUFACTURER expressly reserves the right to use all legal means at its disposal to recover damages it has suffered or may suffer as a result of defaulting conduct of the purchaser.

7 - Case of Force Majeure

7.1. The MANUFACTURER shall not be liable before the purchaser for any breach of contract, including non-delivery or delayed delivery of the PRODUCT, caused by events that are beyond its control, such as the non-delivery or late delivery of materials by suppliers, facilities breakdowns, strikes, facts of nature, interruptions in power supply, suspension or transport difficulties.

8 - Applicable Law - Competent Jurisdiction

8.1. Any dispute arising out of or relating to this sale shall be submitted exclusively to the courts of the seller's registered office, to the exclusion of any other jurisdiction.

1 - Conditions applicables

1.1. Les conditions générales, précisées et énumérées ci-après, dénommées les « CONDITIONS », font partie intégrante du contrat de vente de carrelages et autres produits céramiques - ci-après dénommés le « PRODUIT » ou les « PRODUITS » - fabriqués par Margres - Gres Panaria Portugal, S.A., également dénommé le « FABRICANT ».

1.2. Sauf cas particuliers ou exceptionnels, où l'application de ces conditions générales est expressément modifiée par un accord écrit et signé par le FABRICANT, celles-ci représentent les conditions exclusives appliquées à cette vente. Si une ou plusieurs parties de ces CONDITIONS ou contrats, individuellement considérés et dont elles en font partie, sont de quelque manière que ce soit considérées comme nulles, invalides ou inapplicables pour des raisons de force majeure, les CONDITIONS générales ou particulières resteront valables dans leur ensemble, les conditions invalides étant remplacées par de nouvelles dispositions qui reproduiront, autant que possible, l'intention initiale des parties.

1.3. Les ventes effectuées par notre entreprise sont régies par la Convention des Nations Unies sur les contrats de vente internationale de marchandises (CVIM — Vienne, 1980). Les parties conviennent que toutes les questions relatives à la formation du contrat, à son exécution, aux défauts de conformité, aux garanties, aux responsabilités et aux droits des parties seront interprétées conformément à la CVIM. L'acheteur s'engage à examiner les marchandises et à notifier tout défaut de conformité dans les délais prévus aux articles 38 et 39 de la Convention, sauf stipulation contractuelle contraire.

2 - Exécution du contrat de vente - Livraison des produits

2.1. Le contrat est conclu lorsque le vendeur ou l'acquéreur prend connaissance de l'acceptation écrite du contrat par l'autre partie.

2.2. Une commande qui n'a pas été confirmée par écrit ne peut en aucun cas être considérée comme acceptée, à moins qu'elle n'ait été exécutée par le FABRICANT par l'expédition ou la livraison des PRODUITS. La livraison partielle des PRODUITS commandés n'implique pas l'acceptation de l'intégralité de la commande, mais uniquement de la partie des PRODUITS effectivement livrée.

2.3. Sauf accord préalable et exprès contraire, la livraison des PRODUITS sera effectuée exclusivement sur le territoire du Portugal continental et à condition qu'il soit possible et autorisé d'accéder des véhicules lourds avec des semi-remorques de 24 (vingt-quatre) tonnes de poids brut au lieu de livraison.

2.4. Sauf convention contraire expresse fixée par écrit, toutes les dates indiquées aux fins de la livraison seront considérées comme des dates approximatives.

3 - Caractéristiques des produits - Garantie - Réclamations

3.1. LES PRODUITS fabriqués par Margres - Gres Panaria Portugal, S.A., sont produits conformément aux normes européennes applicables. Le FABRICANT vend de préférence à des revendeurs professionnels, qui sont responsables de fournir des informations techniques correctes et appropriées aux utilisateurs finaux ou aux détaillants.

Le classement des PRODUITS est indiqué par le FABRICANT dans le matériel publicitaire et / ou dans les listes de prix. En conséquence, l'acquéreur doit utiliser les PRODUITS conformément aux spécifications du FABRICANT.

Afin de faciliter la suggestion d'utilisation et d'adapter la spécification standard à la production spécifique du FABRICANT, en ce qui concerne tous les produits, listes de prix ou catalogues, des symboles spécifiques sont ajoutés, indiquant l'utilisation recommandée de chaque produit par le FABRICANT.

3.2. Les différences de tonalité ou de chrominance qui peuvent être constatées ne sont pas dues à des défauts du PRODUIT, mais si à une caractéristique spécifique du matériau céramique après avoir été soumis à une cuisson à haute température. La particularité de « résistance au gel » ne s'applique qu'aux produits spécifiquement garantis par le FABRICANT à cet effet, tel qu'indiqué dans son matériel publicitaire et / ou dans les listes de prix. Cette indication n'étant pas présente, les produits sont uniquement et exclusivement conçus pour être utilisés en intérieur ou, dans tous les cas, dans des lieux non exposés à des éléments atmosphériques qui altèrent les caractéristiques de résistance ou l'aspect d'origine du PRODUIT (par exemple : précipitations atmosphériques, soleil, humidité, basses températures, etc.).

3.3. Les carreaux aux faces polies peuvent changer d'apparence lorsqu'elles sont utilisées sur le sol des pièces avec accès à l'extérieur ou des espaces où une circulation piétonne régulière est prévue. Les carreaux polis peuvent également être glissantes, surtout lorsqu'elles sont mouillées ou sous l'effet de l'humidité. Compte tenu de cette caractéristique, le FABRICANT déconseille d'utiliser ces PRODUITS dans les lieux publics. Pour les espaces avec une circulation intense de personnes, l'acquéreur doit acheter exclusivement les PRODUITS classés par le FABRICANT comme « PEI V » ou le « Grès cérame pleine masse », en particulier les PRODUITS que le FABRICANT recommande spécifiquement pour une utilisation dans les espaces publics.

3.4. La présentation des PRODUITS sur des dépliants ou tout autre matériel promotionnel du FABRICANT est purement illustrative et ne représente pas nécessairement le résultat esthétique final de la pose de ce produit spécifique.

3.5. Le FABRICANT garantit la bonne qualité et l'absence de défauts dans les PRODUITS fournis.

La garantie ne s'applique pas aux PRODUITS classés par le FABRICANT comme inférieures à la qualité de 1er choix, ni aux stocks de produits dont la production est abandonnée, lorsqu'ils sont vendus en vrac ou indiqués comme lot spécial.

conditions générales de vente

3.6. Le FABRICANT n'est pas responsable des défauts et / ou anomalies existant dans les PRODUITS pouvant découler du non-respect des spécifications techniques de ceux-ci, résultant d'une mauvaise utilisation des PRODUITS par les acheteurs et / ou des tiers agissant en leur nom. En particulier, le FABRICANT n'accepte aucune réclamation ou contestation liée aux situations décrites ci-dessus.

3.7. Les réclamations résultant de l'existence de défauts évidents ou cachés doivent être adressées par écrit au FABRICANT par l'acquéreur dans un délai de 60 jours à compter de la date de livraison des marchandises. La responsabilité du fabricant à l'égard des défauts inhérents aux produits livrés à l'acquéreur est expressément limitée à une période de 2 ans à compter de la date de réception des marchandises par l'acquéreur.

3.8. En général, la garantie ne s'applique qu'aux défauts constatés dans les produits qui n'ont pas encore été appliqués. En ce qui concerne les défauts détectés après la pose des PRODUITS, la garantie ne peut s'appliquer que lorsque le FABRICANT confirme que celle-ci a été réalisée conformément aux meilleures règles du métier (DIN 18352) et aux procédures décrites dans le manuel de pose et d'entretien du FABRICANT.

3.9. La garantie accordée par le FABRICANT est limitée au remplacement des produits défectueux par d'autres produits du même type sans défaut, majoré des frais de port. Le remboursement de tous autres frais et / ou dépenses et notamment des frais de démolition et de remplacement est expressément exclu. Dans tous les cas, la garantie du FABRICANT ne peut excéder cinq fois la valeur du matériau réclamé, jusqu'à un montant de 10 000 euros maximum.

3.10. Le FABRICANT ne peut pas être tenu responsable des réclamations dues à tout classement des matériaux céramiques effectué par des organismes de certification et de contrôle différents des organismes européens indiqués à l'article 3.1, sur la base des spécifications techniques qui ne correspondent pas à celles indiquées par le FABRICANT. Toute analyse technique spécialisée éventuelle, demandée par l'acquéreur, sera basée sur la correspondance des matériaux vendus avec les caractéristiques techniques indiquées par le FABRICANT, à présent applicables au Portugal.

4 - Prix et modalités de paiement

4.1. Les prix de vente des PRODUITS sont indiqués dans la liste de prix du FABRICANT, en vigueur à la date de confirmation de la commande. Pour les contrats de vente avec des livraisons séparées, le prix sera celui indiqué dans la liste de prix en vigueur à la date de chaque livraison, sauf si les parties contractantes en ont convenu autrement par écrit.

Pour les PRODUITS destinés aux marchés étrangers, le prix sera calculé, comme indiqué par le FABRICANT, dans la devise étrangère du pays de destination ou en Euros.

4.2. Sauf convention contraire expresse, les paiements seront effectués par virement bancaire, dans les 30 jours suivant la date de facturation. Tous les frais bancaires et de transfert sont à la charge de l'acquéreur. En cas de retard de paiement, le FABRICANT aura le droit, sans notification préalable à l'acheteur, d'appliquer un taux d'intérêt de retard et punitif équivalent au taux EURIBOR à 6 mois majoré de 5%, sans préjudice du droit à l'indemnisation pour tout autre dommage.

5 - Agents du fabricant

5.1. Les agents du FABRICANT doivent promouvoir la vente des PRODUITS, mais ne sont pas autorisés à agir pour le compte du FABRICANT, sauf s'ils obtiennent une autorisation expresse spécifique à cet effet.

5.2. Les commandes reçues par les agents n'engagent pas le FABRICANT. Elles doivent donc être expressément acceptées par écrit par le FABRICANT lui-même.

6 - Réserve de propriété

6.1. Les parties conviennent que la vente des PRODUITS est effectuée sous réserve de propriété par le FABRICANT jusqu'au paiement intégral du prix convenu, par l'acquéreur. Cependant, le risque de perte de la marchandise est transféré à l'acquéreur lors de la livraison des PRODUITS.

6.2. Dans le cas de ventes à l'étranger, lorsque les marchandises sont vendues et livrées à des tiers dans le cadre des activités commerciales normales de l'acquéreur et que le transfert de propriété des marchandises n'a pas encore eu lieu, le droit de réserve de propriété du FABRICANT reste valable à l'égard des tiers.

6.3. En cas de retard de paiement, le FABRICANT a le droit, sans avoir recours à aucune formalité, y compris à toute mise en demeure adressée à l'acquéreur, de retirer toutes les marchandises sous réserve de propriété et, lorsque légalement prévu, tous titres de crédit auprès de tiers. Le FABRICANT est en droit, qui lui est expressément réservé, de recourir à tous les moyens juridiques à sa disposition en vue de compenser les pertes qu'il a subies ou subira du fait du comportement fautif de l'acquéreur.

7 - Force majeure

7.1. Le FABRICANT ne sera pas responsable envers l'acheteur de toute violation du contrat, y compris la non-livraison ou la livraison tardive du PRODUIT, causée par des événements indépendants de sa volonté et qui sont hors de son contrôle, tels que la non-livraison ou la livraison retardée des matériaux, de la part des fournisseurs, dysfonctionnements des locaux, grèves, faits de la nature, interruptions de l'approvisionnement en électricité, suspension ou difficultés de transport.

8 - Loi applicable - Jurisdiction compétente

8.1. Pour la résolution de tout litige découlant de la présente vente, les parties conviennent que le tribunal compétent, à l'exclusion de tout autre, est celui du siège du vendeur.

index

colour map

collections

linea collections

useful information

calibers

certification

general sales conditions

important notes

laying suggestions

margres green

margres tools

outdoor extra thick

package

Protect

sustainable choice

symbols

technical information



allgemeine verkaufsbedingungen

1 - Anwendbarkeit der Bedingungen

1.1. Die nachstehend aufgeführten und definierten allgemeinen Bedingungen - im Folgenden als "BEDINGUNGEN" bezeichnet - sind integraler Bestandteil des Vertrags für den Kauf und Verkauf von Mosaikfliesen und anderen keramischen Produkten - im Folgenden als "PRODUKT" oder "PRODUKTE" bezeichnet - hergestellt von Margres - Gres Panaria Portugal, S.A., auch als "HERSTELLER" bezeichnet.

1.2. Außer in besonderen oder außergewöhnlichen Fällen, in denen die Anwendung dieser Bedingungen ausdrücklich durch eine schriftliche Vereinbarung geändert und vom HERSTELLER unterzeichnet wurden, stellen sie die ausschließlichen Bedingungen dar, die in Verbindung mit einem solchen Verkauf geltend gemacht werden können. Wenn ein oder mehrere Teile dieser BEDINGUNGEN oder Verträge einzeln betrachtet werden und Bestandteil dieser sind, aufgrund höherer Gewalt in irgendeiner Weise als nichtig, ungültig oder nicht durchsetzbar gelten, bleiben die allgemeinen oder besonderen BEDINGUNGEN als Ganzes gültig. Die ungültigen Bedingungen werden durch neue Bestimmungen ersetzt, die so weit wie möglich die ursprüngliche Absicht der Parteien wiedergeben.

1.3. Sämtliche von unserem Unternehmen durchgeführten Verkäufe unterliegen dem Übereinkommen der Vereinten Nationen über Verträge über den internationalen Warenkauf (CISG, Wien 1980).Die Parteien vereinbaren, dass alle Fragen zum Vertragsabschluss, zur Vertragserfüllung, zur Nichtkonformität, zu Gewährleistungen, Haftungen und den Rechten der Parteien nach dem CISG ausgelegt werden. Der Käufer verpflichtet sich, die Ware zu prüfen und jede Vertragswidrigkeit innerhalb der in den Artikeln 38 und 39 des Übereinkommens vorgesehenen Fristen anzuzeigen, es sei denn, die Parteien haben etwas anderes vereinbart.

2 - Ausführung des Kaufvertrags - Lieferung von Produkten

2.1. Der Vertrag ist abgeschlossen, wenn der vorschlagenden Partei oder dem Käufer die schriftliche Annahme durch die Gegenpartei bekannt ist.

2.2. Eine Bestellung, die nicht schriftlich bestätigt wurde, kann unter keinen Umständen als angenommen betrachtet werden, es sei denn, sie wurde vom HERSTELLER durch den Versand oder die Lieferung der PRODUKTE ausgeführt. Die Teillieferung der bestellten PRODUKTE bedeutet nicht die Annahme der gesamten Bestellung, sondern nur des Teils der PRODUKTE, der tatsächlich geliefert worden ist.

2.3. Die Lieferung der PRODUKTE erfolgt ausschließlich auf dem portugiesischen Festland und unter der Bedingung, dass schwere Fahrzeuge mit Sattelanhängern von 24 (vierundzwanzig) Tonnen Bruttogewicht den Lieferort erreichen können und dürfen, es sei denn, es wurde im Voraus ausdrücklich etwas anderes vereinbart.

2.4. Sofern nicht ausdrücklich anders vereinbart, gelten alle für Lieferzwecke angegebenen Daten als ungefähre Daten.

3 - Eigenschaften der Produkte - Garantie - Reklamationen

3.1. Die von Margres - Gres Panaria Portugal, S.A. hergestellten PRODUKTE werden in Übereinstimmung mit den geltenden europäischen Normen hergestellt. Der HERSTELLER verkauft vorzugsweise an professionelle Wiederverkäufer. Diese sind für die Bereitstellung korrekter und angemessener technischer Informationen für Endbenutzer oder Einzelhändler verantwortlich.

Die Klassifizierung der PRODUKTE wird vom HERSTELLER auf Werbematerial und/oder Preislisten angegeben. Folglich muss der Käufer die PRODUKTE in Übereinstimmung mit den Spezifikationen des HERSTELLERS verwenden.

Um den Verwendungsvorschlag zu erleichtern und die Standardspezifikation an die spezifische Produktion des HERSTELLERS anzupassen, sind auf allen Produkten, Preislisten oder Katalogen spezifische Symbole angebracht, die die vom HERSTELLER empfohlene Verwendung für jedes Produkt angeben.

3.2. Die Unterschiede in Tonalität oder Farbe , wenn überhaupt, sind nicht auf Fehler im PRODUKT zurückzuführen, sondern eine spezifische Eigenschaft des keramischen Materials, das bei hohen Temperaturen gebrannt wurde. Die besondere Eigenschaft der "Frostbeständigkeit" gilt nur für Produkte, für die der HERSTELLER ausdrücklich in seinen Werbematerialien und/oder in den Preislisten diese Garantie gibt. Fehlt diese Angabe, werden die Produkte nur und ausschließlich für die Verwendung in Innenräumen oder jedenfalls für die Verwendung an Orten betrachtet, die nicht atmosphärischen Elementen ausgesetzt sind, die die Haltbarkeitseigenschaften oder das ursprüngliche Aussehen des PRODUKTES verändern (z. B. atmosphärischer Niederschlag, Sonne, Feuchtigkeit, niedrige Temperaturen, etc.).

3.3. Die Fliesen mit den polierten Oberflächen können ihr Aussehen verändern, wenn sie als Bodenbelag in Räumen verwendet werden, die von außen zugänglich sind, oder in Räumen, in denen intensiver Fußgängerverkehr erwartet wird. Polierte Fliesen können auch rutschig sein, insbesondere wenn sie nass oder feucht sind. Aus diesem Grund rät der HERSTELLER davon ab, diese PRODUKTE an öffentlichen Orten zu verwenden. Für Orte, an denen intensiver Fußgängerverkehr zu erwarten ist, sollte der Käufer nur PRODUKTE kaufen, die vom HERSTELLER als "PEI V" oder "Vollmassiges Feinsteinzeug" klassifiziert werden, insbesondere solche PRODUKTE, die der HERSTELLER speziell für die Verwendung an öffentlichen Orten empfiehlt.

3.4. Die Präsentationen der PRODUKTE in Broschüren oder in anderem Werbematerial des HERSTELLERS dienen lediglich der Veranschaulichung und stellen nicht unbedingt das ästhetische Endergebnis dar, das sich aus der Installation dieses spezifischen Produkts ergibt.

3.5. Der HERSTELLER garantiert die gute Qualität und die Mängelfreiheit der gelieferten PRODUKTE.

Die Garantie gilt nicht für PRODUKTE, die vom HERSTELLER als minderwertig gegenüber der Qualität der 1. Wahl eingestuft werden, oder für die Lagerbestände von Produkten, die eingestellt wurden, wenn sie lose verkauft oder als Sonderposten angegeben werden.

3.6. Der HERSTELLER haftet nicht für Mängel und/oder Anomalien der PRODUKTE, die sich nicht aus den technischen Spezifikationen derselben ableiten, sondern aus der unsachgemäßen Verwendung der PRODUKTE durch die Käufer und/oder in ihrem Namen handelnde Dritte entstehen. Insbesondere akzeptiert der HERSTELLER keine Beschwerden oder Streitigkeiten im Zusammenhang mit den oben beschriebenen Situationen.

3.7. Ansprüche, die sich aus dem Vorhandensein von patentierten oder versteckten Mängeln ergeben, müssen vom Käufer innerhalb von 60 Tagen nach Lieferung der Ware schriftlich dem HERSTELLER bekannt gemacht werden. Die Haftung des Herstellers für Mängel an den an den Käufer gelieferten Produkten ist ausdrücklich auf einen Zeitraum von 2 Jahren ab dem Datum des Erhalts der Ware durch den Käufer beschränkt.

3.8. Im Allgemeinen gilt die Garantie nur für Mängel an Produkten, die noch nicht angewendet wurden. Für Mängel, die nach der Anwendung der PRODUKTE festgestellt werden, kann die Garantie nur dann gelten, wenn der HERSTELLER bestätigt hat, dass die Installation des PRODUKTES nach den besten Praktiken (DIN 18352) sowie in Übereinstimmung mit den im Anwendungs- und Wartungshandbuch des HERSTELLERS beschriebenen Verfahren durchgeführt wurde.

3.9. Die vom HERSTELLER gewährte Garantie beschränkt sich auf den Ersatz defekter Produkte durch andere Produkte desselben Typs ohne Mängel, zuzüglich Transportkosten. Die Erstattung sonstiger Kosten und/oder Aufwendungen, insbesondere Abbruch- und Umzugskosten, ist ausdrücklich ausgeschlossen. In jedem Fall darf die Garantie des HERSTELLERS den fünffachen Wert des beanspruchten Materials bis zu einem Höchstbetrag von 10.000 Euro nicht überschreiten.

3.10. Der HERSTELLER ist nicht verantwortlich für Ansprüche aufgrund einer Klassifizierung von keramischen Materialien, die von anderen als den in Artikel 3.1 angegebenen europäischen Zertifizierungs- und Kontrollorganen auf der Grundlage technischer Spezifikationen vorgenommen wurden, die nicht den vom HERSTELLER angegebenen entsprechen. Jede spezialisierte technische Analyse, die vom Käufer angefordert wird, basiert auf der Übereinstimmung der verkauften Materialien mit den vom HERSTELLER angegebenen technischen Eigenschaften, die zu diesem Zeitpunkt in Portugal gelten.

4 - Preise und Zahlungsbedingungen

4.1. Die Verkaufspreise der PRODUKTE sind diejenigen, die in der am Datum der Auftragsbestätigung gültigen Preisliste des HERSTELLERS angegeben sind. Bei Kaufverträgen mit getrennten Lieferungen gilt der Preis, der in der am Tag der jeweiligen Lieferung gültigen Preisliste angegeben ist, sofern die Vertragsparteien nichts anderes schriftlich vereinbart haben.

Für PRODUKTE, die für ausländische Märkte bestimmt sind, wird der Preis nach Angaben des HERSTELLERS in der Fremdwährung des Bestimmungslandes oder in Euro berechnet.

4.2. Sofern nicht ausdrücklich anders vereinbart, sind Zahlungen per Banküberweisung innerhalb von 30 Tagen ab Rechnungsdatum zu leisten. Alle Bank- und Überweisungsgebühren gehen zu Lasten des Käufers. Bei Zahlungsverzug ist Der HERSTELLER hat das Recht, ohne vorherige Ankündigung an den Käufer einen Verzugszinssatz und Strafsinsen in Höhe des 6-Monats-EURIBOR-Satzes zuzüglich 5 % zu erheben, unbeschadet des Rechts auf Entschädigung für sonstige Verluste.

5 - Vertreter des Herstellers

5.1. Die Vertreter des HERSTELLERS werben für den Verkauf der PRODUKTE und sind nicht befugt, im Namen und im Auftrag des HERSTELLERS zu handeln, es sei denn, sie erhalten dafür eine ausdrückliche Sondergenehmigung.

5.2. Aufträge, die von Vertretern entgegengenommen werden, sind für den HERSTELLER nicht bindend und müssen daher vom HERSTELLER selbst ausdrücklich und schriftlich angenommen werden.

6 - Eigentumsvorbehalt

6.1. Es wird zwischen den Parteien vereinbart, dass der Verkauf der PRODUKTE unter Eigentumsvorbehalt seitens des HERSTELLERS erfolgt, bis der Käufer den vereinbarten Preis vollständig bezahlt hat. Das Verlustrisiko der Waren geht jedoch mit der Lieferung der PRODUKTE auf den Käufer über.

6.2. Im Falle von Verkäufen ins Ausland bleibt der Eigentumsvorbehalt des HERSTELLERS gegenüber dem Dritten bestehen, wenn die Waren im Rahmen der normalen Geschäftstätigkeit des Käufers an einen Dritten verkauft und geliefert werden und das Eigentumsrecht an den Waren noch nicht übertragen wurde.

6.3. Bei Zahlungsverzug hat der HERSTELLER das Recht, ohne jegliche Formalität, einschließlich irgendwelcher vorherigen Benachrichtigung des Käufers, alle unter Eigentumsvorbehalt stehenden Waren und, falls gesetzlich erlaubt, alle Kreditittel vor Dritten einzuziehen, wobei dem HERSTELLER ausdrücklich das Recht vorbehalten bleibt, alle ihm zur Verfügung stehenden rechtlichen Mittel einzusetzen, um den Schaden, den er aufgrund des säumigen Verhaltens des Käufers erlitten hat oder erleiden wird, wieder gutzumachen.

7 - Fall von höherer Gewalt

7.1. Der HERSTELLER ist nicht haftbar gegenüber dem Käufer für jegliche Vertragsverletzung, einschließlich der Nichtlieferung oder verspäteten Lieferung des PRODUKTS, die auf Ereignisse zurückzuführen sind, die außerhalb seiner Kontrolle liegen, wie z.B. Nichtlieferung oder verspätete Lieferung von Materialien durch Lieferanten, Betriebsstörungen, Streiks, Naturkatastrophen, Unterbrechungen der Stromversorgung, Aussetzung oder Transportschwierigkeiten.

8 – Anwendbares Recht – Zuständiges Gericht

8.1. Die Parteien vereinbaren, dass sämtliche Streitigkeiten, die sich aus oder im Zusammenhang mit dem Abschluss, der Wirksamkeit, der Auslegung oder der Erfüllung dieses Vertrags ergeben, ausschließlich der Gerichtsbarkeit der Gerichte am Sitz des Verkäufers unterliegen. Auf jeglichen anderen Gerichtsstand wird ausdrücklich verzichtet.

MARGRES
C E R A M I C T I L E S

condições gerais de venda

1 - Aplicabilidade das Condições

1.1. As condições gerais em seguida elencadas e especificadas - de ora em diante denominadas "CONDIÇÕES" -, constituem parte integrante do contrato de compra e venda de mosaicos e outros produtos cerâmicos - de ora em diante designados como o "PRODUTO" ou os "PRODUTOS" - fabricados pela Margres - Gres Panaria Portugal, S.A., também designado como o "FABRICANTE".

1.2. Salvo casos específicos ou excepcionais, em que a aplicação destas condições seja expressamente alterada através de acordo escrito e assinado pelo FABRICANTE, elas representam as condições exclusivas aplicadas a essa venda. Se uma ou mais partes das presentes CONDIÇÕES ou contratos, individualmente considerados, dos quais elas façam parte, forem alguma forma julgadas nulas, inválidas ou inaplicáveis por razões de força maior, as CONDIÇÕES gerais ou particulares permanecerão válidas no seu conjunto, sendo que as condições inválidas serão substituídas por novas disposições que reproduzirão, tanto quanto possível, a intenção original das partes.

1.3. As vendas efetuadas pela nossa empresa são regidas pela Convenção das Nações Unidas sobre Contratos para à Venda Internacional de Mercadorias (CISG — Viena, 1980). As partes acordam que todas as questões relativas à formação do contrato, cumprimento, falta de conformidade, garantias, responsabilidades e direitos das partes serão interpretadas de acordo com a CISG. O comprador compromete-se a examinar as mercadorias e a notificar eventuais faltas de conformidade nos prazos previstos nos artigos 38.º e 39.º da Convenção, salvo estipulação contratual diversa.

2 - Execução do Contrato de Venda - Entrega dos Produtos

2.1. O contrato é celebrado quando a parte proponente ou o comprador tiver conhecimento da aceitação escrita do mesmo pela contraparte.

2.2. Uma encomenda que não tiver sido confirmada por escrito não pode em nenhuma circunstância ser considerada como aceite, excepto se tiver sido executada pelo FABRICANTE através do envio ou da entrega dos PRODUTOS. A entrega parcial dos PRODUTOS encomendados não implica a aceitação da totalidade da encomenda, mas apenas da parte dos PRODUTOS que tenham sido efectivamente entregues.

2.3. Excepto se for, prévia e expressamente diversamente acordado, a entrega dos PRODUTOS será efectuada exclusivamente no território de Portugal Continental e na condição de que seja possível e permitido o acesso ao local de entrega de veículos pesados com semi-reboque de 24 (vinte e quatro) toneladas de peso bruto.

2.4. Excepto se o contrário for expressamente acordado por escrito, a entrega dos PRODUTOS apenas será efectuada em obra se a encomenda a entregar for superior a 100m2 (cem metros quadrados).

2.5. Salvo acordo expresso em contrário, todas as datas que forem indicadas para efeitos de entrega, serão consideradas como datas aproximadas.

3 - Características dos Produtos - Garantia - Reclamações

3.1. Os PRODUTOS fabricados pela Margres - Gres Panaria Portugal, S.A. são produzidos em conformidade com as normas europeias aplicáveis. O FABRICANTE vende preferencialmente a revendedores profissionais, sendo estes os responsáveis por prestarem informações técnicas correctas e adequadas aos utilizadores finais ou aos retalhistas.

A classificação dos PRODUTOS é indicada pelo FABRICANTE no material publicitário e/ ou nas tabelas de preços. Em consequência, o comprador deverá usar os PRODUTOS em conformidade com as especificações do FABRICANTE.

Para facilitar a sugestão de uso e adaptar a especificação standard à produção específica do FABRICANTE, sobre todos os produtos, listas de preços ou catálogos existem símbolos específicos que indicam a utilização aconselhada para cada produto por parte do FABRICANTE.

3.2. As diferenças de tonalidade ou crominância eventualmente constáveis não decorrem de defeitos do PRODUTO, sendo sim uma característica específica do material cerâmico que foi submetido a cozedura a altas temperaturas. A característica especial de "resistência à congelação" apenas se aplica aos produtos que o FABRICANTE tenha especificamente garantido para esse efeito através de uma indicação expressa no seu material publicitário e/ou nas tabelas de preços. No caso de inexistência desta indicação, os produtos serão considerados única e exclusivamente para utilização em interior ou, em qualquer caso, para utilização em locais que não estejam expostos a elementos atmosféricos que alterem as características de resistência ou aparência original do PRODUTO (ex.: precipitação atmosférica, sol, humidade, temperaturas baixas, etc.).

3.3. Os mosaicos com as faces polidas podem alterar o seu aspecto quando utilizados no pavimento de divisões que tenham acesso a partir do exterior, ou divisões onde se preveja intensa circulação pedonal. Os mosaicos polidos podem também ser escorregadios, especialmente quando estiverem molhados ou sob o efeito de humidade. Atento a este motivo o FABRICANTE desaconselha

a utilização destes PRODUTOS em locais públicos. Para os locais de circulação intensa de pessoas, o comprador apenas deverá adquirir PRODUTOS classificados pelo FABRICANTE como "PEI V" ou "Grés Porcelânico Toda-a-Massa", em particular os PRODUTOS que o FABRICANTE recomendar especificamente para utilização em locais públicos.

3.4. As apresentações dos PRODUTOS em folhetos ou em qualquer outro material promocional do FABRICANTE são meramente ilustrativos e não representam necessariamente o resultado final estético decorrente da instalação desse produto específico.

3.5. O FABRICANTE garante a boa qualidade e a ausência de defeitos nos PRODUTOS fornecidos.

A garantia não se aplica aos PRODUTOS classificados pelo FABRICANTE como inferiores à qualidade de 1º escolha, ou aos stocks de produtos que tenham sido descontinuados, quando forem vendidos a granel ou indicados como lote especial.

index

colour map

collections

linea collections

useful information

calibers

certification

general sales

conditions

important notes

laying suggestions

margres green

margres tools

outdoor extra thick

package

Protect

sustainable choice

symbols

technical information



condiciones generales de venta

1 - Aplicabilidad de las Condiciones

1.1. Las condiciones generales enumeradas y especificadas a continuación –en adelante denominadas “CONDICIONES” -, constituyen parte integrante del contrato de compraventa de baldosas y de otros productos cerámicos –en adelante designados como el “PRODUCTO” o los “PRODUCTOS” - fabricados por Margres - Gres Panaria Portugal, S.A., también designado como el “FABRICANTE”.

1.2. Salvo casos específicos o excepcionales, en los que la aplicación de estas condiciones sea expresamente alterada a través de un acuerdo por escrito y firmado por el FABRICANTE, las mismas representan las condiciones exclusivas aplicadas a esta venta. Si una o más partes de las presentes CONDICIONES o contratos, individualmente considerados y de los cuales formen parte, fuesen consideradas nulas, inválidas o inaplicables, por razones de fuerza mayor, las CONDICIONES generales o particulares permanecerán válidas en su conjunto, sustituyéndose las condiciones inválidas por nuevas disposiciones que reproducirán, lo mejor posible, la intención original de las partes.

1.3. Las ventas realizadas por nuestra empresa se rigen por la Convención de las Naciones Unidas sobre Contratos de Compraventa Internacional de Mercaderías (CISG — Viena, 1980). Las partes acuerdan que todas las cuestiones relativas a la formación del contrato, cumplimiento, falta de conformidad, garantías, responsabilidades y derechos de las partes serán interpretadas de acuerdo con la CISG. El comprador se compromete a examinar las mercancías y a notificar cualquier falta de conformidad dentro de los plazos previstos en los artículos 38 y 39 de la Convención, salvo estipulación contractual en contrario.

2 – Ejecución del Contrato de Venta - Entrega de los Productos

2.1. El contrato se celebra cuando la parte proponente o el comprador tenga conocimiento de la aceptación escrita del mismo por la contraparte.

2.2. Un pedido que no haya sido confirmado por escrito no podrá, en ningún caso, ser considerado como aceptado, a menos que haya sido ejecutado por el FABRICANTE mediante el envío o la entrega de los PRODUCTOS. La entrega parcial de los PRODUCTOS del pedido no implica la aceptación de la totalidad del pedido, sino tan solo la parte de los PRODUCTOS que efectivamente han sido entregados.

2.3. Salvo que se acuerde previa y expresamente lo contrario, la entrega de los PRODUCTOS se realizará exclusivamente en el territorio de Portugal continental y a condición de que sea posible y permitido el acceso de vehículos pesados con semirremolques de 24 (veinticuatro) toneladas de peso bruto al lugar de entrega.

2.4. Salvo acuerdo expreso en contrario, todas las fechas que se indiquen a efectos de entrega serán consideradas como fechas aproximadas.

3 - Características de los Productos - Garantía - Reclamaciones

3.1. Los PRODUCTOS fabricados por Margres - Gres Panaria Portugal, S.A. se elaboran de acuerdo con las normas europeas aplicables. El FABRICANTE vende, de preferencia, a revendedores profesionales, que son responsables de prestar las informaciones técnicas correctas y adecuadas a los utilizadores finales o a los minoristas.

El FABRICANTE indicará la clasificación de los PRODUCTOS en el material publicitario y/o en las listas de precios. Así, el comprador deberá usar los PRODUCTOS conforme las especificaciones del FABRICANTE.

Para facilitar la sugerencia de utilización y adaptar la especificación estándar a la producción específica del FABRICANTE, existen, en todos los productos, listas de precios o catálogos, símbolos específicos que indican la utilización aconsejada para cada producto, por parte del FABRICANTE.

3.2. Las diferencias de tonalidad o crominancia que eventualmente puedan constar, no se deben a defectos del PRODUCTO, sino que es una característica específica del material cerámico que ha sido sometido a cocción, a altas temperaturas. La característica especial de “resistencia a la congelación” apenas se aplica a los productos garantizados como tales por el FABRICANTE, a través de una indicación expresada en su material publicitario y/o en las listas de precios. Cuando no exista esta indicación, los productos serán considerados única y exclusivamente para utilización en interior o, en cualquier caso, para ser utilizados en lugares que no se encuentren expuestos a los elementos atmosféricos que puedan alterar las características de resistencia o apariencia original del PRODUCTO (ej.: precipitación atmosférica, sol, humedad, bajas temperaturas, etc.).

3.3. Las baldosas de caras pulidas pueden sufrir alteraciones de aspecto cuando se utilicen como pavimento de estancias cuyo acceso se realice a partir del exterior, o estancias en las que se prevea una intensa circulación peatonal. Las baldosas pulidas también pueden resultar escurridizas, especialmente cuando están mojadas o por efecto de la humedad. Considerando este último aspecto, el FABRICANTE no recomienda utilizar estos PRODUCTOS en locales públicos. Para aquellos lugares con una circulación intensa de personas, el comprador apenas deberá adquirir PRODUCTOS clasificados por el FABRICANTE como “PEI V” o “Gres Porcelánico Todo Masa”, en particular los PRODUCTOS recomendados por el FABRICANTE específicamente para ser utilizados en lugares públicos.

3.4. Las presentaciones de los PRODUCTOS en folletos o en cualquier otro material promocional del FABRICANTE son meramente ilustrativos y, no tienen por qué representar el resultado final estético tras la instalación de ese producto específico.

3.5. El FABRICANTE garantiza la buena calidad y la ausencia de defectos en los PRODUCTOS suministrados.

La garantía no se aplica a los PRODUCTOS clasificados por el FABRICANTE como inferiores a los de tra calidad, o a los stocks de productos descontinuados, cuando se vendan a granel o estén indicados como lote especial.

3.6. El FABRICANTE no se responsabiliza por cualquier defectos y/o anomalías existentes en los PRODUCTOS que no resulten de las especificaciones técnicas de los mismos, sino que se deban a un uso inadecuado de los PRODUCTOS por parte de los adquirentes y/o de terceros que actúen en su nombre. En concreto, el FABRICANTE no acepta ninguna reclamación o litigio relacionada con las situaciones anteriormente descritas.

3.7. Las reclamaciones resultantes de la existencia de defectos patentes u ocultos tendrán que ser efectuadas por el comprador, por escrito, dirigidas al FABRICANTE, en un plazo de 60 días a partir de la fecha de entrega de las mercancías. La responsabilidad del Fabricante por defectos inherentes a los productos entregados al comprador queda expresamente limitada al plazo de 2 años a partir de la fecha de recepción de los bienes por parte del comprador.

3.8. En general, la garantía apenas se aplica a los defectos detectados en productos que aún no han sido aplicados. En relación a los defectos detectados tras la aplicación de los PRODUCTOS, la garantía apenas se podrá aplicar si el FABRICANTE hubiera confirmado que la instalación del PRODUCTO fue realizada de acuerdo con las mejores reglas de la actividad (DIN 18352), así como conforme a los procedimientos descritos en el manual de aplicación y mantenimiento del FABRICANTE.

3.9. La garantía concedida por el FABRICANTE se limita a la sustitución de los productos defectuosos por otros productos del mismo tipo, sin defecto, más gastos de transporte. Queda expresamente excluido el reembolso de cualquier otros costes y/o gastos, y en particular los costes con demoliciones y reinstalaciones. De cualquier manera, la garantía del FABRICANTE no podrá superar cinco veces el valor del material reclamado, hasta un valor máximo de 10.000 Euros.

3.10. El FABRICANTE no se responsabiliza de ninguna reclamación causada por una clasificación de materiales cerámicos efectuada por organismos de certificación y control diferentes de los europeos, indicados en el artículo 3.1, con base en especificaciones técnicas que no correspondan a las indicadas por el FABRICANTE. Cualquier eventual análisis técnico especializado, solicitado por el comprador se basará en la correspondencia de los materiales vendidos con las características técnicas indicadas por el FABRICANTE, vigentes en Portugal en ese momento.

4 – Precios y condiciones de pago

4.1. Los precios de venta de los PRODUCTOS están indicados en la lista de precios del FABRICANTE, vigente en la fecha de confirmación del pedido. Para contratos de venta con entregas separadas, el precio será el que conste en la lista de precios en vigor en la fecha de cada una de las entregas, excepto cuando las partes contratantes dispongan, por escrito, lo contrario.

Para los PRODUCTOS destinados a mercados extranjeros, el precio se calculará, por indicación del FABRICANTE, en la moneda extranjera del país de destino o en euros.

4.2. Excepto cuando se acuerde expresamente lo contrario, los pagos se efectuarán a través de transferencia bancaria, en un plazo de 30 días a partir de la fecha de la factura. Todos los gastos bancarios y de transferencias correrán por cuenta del comprador. En caso de atraso en la realización del pago, el FABRICANTE tendrá derecho, sin necesidad de previo aviso al comprador, a aplicar un tipo de interés de demora y sancionador equivalente al tipo EURIBOR a 6 meses más el 5%, sin perjuicio del derecho a indemnización por cualesquiera otros perjuicios.

5 - Agentes del Fabricante

5.1. Los agentes del FABRICANTE promueven la venta de los PRODUCTOS y no están autorizados a actuar en nombre y por cuenta del FABRICANTE, excepto cuando obtengan autorización específica expresa al efecto.

5.2. Los pedidos recibidos por los agentes no vinculan al FABRICANTE y, por lo tanto, deberán ser expresamente aceptados, por escrito, por el propio FABRICANTE.

6 – Reserva de Propiedad

6.1. Se acuerda entre las partes que la venta de los PRODUCTOS se efectuará con reserva de propiedad por parte del FABRICANTE, hasta que el pago integral del precio acordado haya sido completamente salidado por parte del comprador. No obstante, el riesgo de pérdida de las mercancías será transferido al comprador en el acto de la entrega de los PRODUCTOS.

6.2. En caso de ventas a países extranjeros, cuando las mercancías son vendidas y entregadas a terceros, en el ámbito de las actividades comerciales normales del Comprador y la propiedad de las mismas aún no haya sido transferida, el derecho de reserva de propiedad del FABRICANTE permanece válido ante terceros.

6.3. En caso de atraso en el pago, el FABRICANTE, sin necesidad de recurrir a cualquier formalidad, incluyendo cualquier aviso previo al comprador, tiene derecho a recoger todas las mercancías sujetas a reserva de propiedad y, si estuviera legalmente consagrado, todos los títulos de crédito ante terceros, quedando reservado expresamente el derecho del FABRICANTE de recurrir a todos los medios legales a su disposición para resarcirse de los perjuicios que haya sufrido o que llegue a sufrir como consecuencia de la conducta incumplidora del Comprador.

7 – Caso de fuerza mayor

7.1. El FABRICANTE no será responsable ante el comprador por cualquier incumplimiento del contrato, incluyendo la falta de entrega o el retraso en la entrega del PRODUCTO, causados por acontecimientos ajenos a su voluntad y que están fuera de su control, como por ejemplo, la no entrega o entrega con atraso de materiales por parte de proveedores, averías en las instalaciones, huelgas, fenómenos de la naturaleza, interrupciones en el suministro de la energía eléctrica, suspensión o dificultad en el transporte.

8 – Legislación aplicable - Fuero competente

8.1. Las partes acuerdan que cualquier litigio relativo a la formación, validez, interpretación o ejecución del presente contrato se someterá exclusivamente a la jurisdicción de los tribunales de la sede del vendedor, con renuncia expresa a cualquier otro fuero.

MARGRES
CERAMIC TILES

основные условия продаж

1– Применимость условий

1.1. Перечисленные и указанные ниже общие условия, в дальнейшем именуемые «УСЛОВИЯ», составляют неотъемлемую часть договора купли-продажи мозаики и других керамических изделий, именуемых в дальнейшем «ПРОДУКТ» или «ПРОДУКЦИЯ», производства Margres - Gres Panaria Portugal, S.A., также известного как “ПРОИЗВОДИТЕЛЬ”.

1.2. За исключением особых или исключительных случаев, когда применение этих условий конкретно изменяется посредством письменного соглашения, составленного и подписанного ПРОИЗВОДИТЕЛЕМ, они представляют собой исключительные условия, применяемые к данной продаже. Если одна или несколько частей настоящих УСЛОВИЙ или договоров, рассматриваемых индивидуально и являющихся неотъемлемой их частью, каким-либо образом считается недействительной или неприменимой по причинам форс-мажора, общие или частные УСЛОВИЯ, в целом, будут оставаться в силе, а недействительные условия будут заменены новыми положениями, которые будут максимально воспроизводить первоначальные намерения сторон.

1.3. Продажи, осуществляемые нашей компанией, регулируются Конвенцией Организации Объединенных Наций о договоре международной купли-продажи товаров (CISG — Вена, 1980 г.). Стороны соглашаются, что все вопросы, касающиеся заключения договора, исполнения, несоответствия, гарантий, обязанностей и прав сторон, должны толковаться в соответствии с CISG. Покупатель обязуется осмотреть товар и уведомить о любом несоответствии в сроки, установленные статьями 38 и 39 Конвенции, если иное не предусмотрено в договоре.

2 – Оформление договора купли-продажи – Доставка товара

2.1. Контракт считается заключенным, когда предлагающая сторона или покупатель узнает о письменном принятии контракта контрагентом.

2.2. Заказ, не подтвержденный в письменной форме, ни при каких обстоятельствах не может считаться принятым, за исключением если он был выполнен ПРОИЗВОДИТЕЛЕМ посредством отправки или доставки ТОВАРА. Частичная доставка заказанных ТОВАРОВ не подразумевает принятие всего заказа, а только той части ТОВАРОВ, которая была фактически доставлена.

2.3. Если ранее и прямо не оговорено иное, доставка ТОВАРА будет осуществляться исключительно в пределах континентальной территории Португалии и при условии, что будет возможно и разрешен доступ к месту доставки грузовым автомобилям с полуприцепом грузоподъемностью 24 (двадцать четыре) тонны, вес брутто.

2.4. Если прямо не согласовано иное, все даты, указанные для целей доставки, будут рассматриваться как приблизительные.

3 – Характеристика продукции – Гарантия - Претензии

3.1. ПРОДУКЦИЯ, производимая Margres - Gres Panaria Portugal, S.A., производится в соответствии с действующими европейскими стандартами. ПРОИЗВОДИТЕЛЬ предпоставляет продавать свою продукцию профессиональным посредникам, которые несут ответственность за предоставление правильной и соответствующей технической информации конечным пользователям, или продавцам розничной торговли.

Классификация ТОВАРОВ указывается ПРОИЗВОДИТЕЛЕМ в рекламных материалах и/ или в прайс-листах. Следовательно, покупатель должен применять ТОВАР в соответствии со спецификациями ПРОИЗВОДИТЕЛЯ.

Для облегчения предложения по использованию и адаптации стандартной спецификации к конкретной продукции ПРОИЗВОДИТЕЛЯ, на всех продуктах, прайс-листах или каталогах есть специальные символы, указывающие на рекомендуемое ПРОИЗВОДИТЕЛЕМ использование для каждого продукта.

3.2. Различия в тональности или в цветности, которые могут оставаться неизменными, не связаны с дефектами ИЗДЕЛИЯ, а являются специфической характеристикой керамического материала, который был подвергнут высокотемпературному обжигу. Особенность «морозостойкости» применима только к продукции, которую ПРОИЗВОДИТЕЛЬ гарантировал специально для этой цели, посредством прямого указания в своих рекламных материалах и/или в прайс-листах. При отсутствие этого указания продукты будут рассматриваться исключительно для использования внутри помещений или, в любом случае, для использования в местах, которые не подвергаются воздействию атмосферных элементов, которые изменяют характеристики сопротивления или первоначальный внешний вид ПРОДУКТА (например: атмосферные осадки, солнце, влажность, низкие температуры и др.).

3.3. Мозаика с полированными поверхностями может изменить свой внешний вид при использовании на полу в помещениях, имеющих доступ снаружи, или в помещениях, где предполагается интенсивное движение пешеходов. Полированная мозаика также может быть скользкой, особенно когда она влажная и находится под воздействием влаги. По этой причине, ПРОИЗВОДИТЕЛЬ не рекомендует использовать эту ПРОДУКЦИЮ в общественных местах. Для пространств с интенсивным движением людей покупатель должен приобретать только ПРОДУКЦИЮ, классифицированную ПРОИЗВОДИТЕЛЕМ, как “PEI V” или “Универсальный Керамогранит”, в частности ту ПРОДУКЦИЮ, которую ПРОИЗВОДИТЕЛЬ рекомендует использовать в общественных местах.

3.4. Представление ПРОДУКЦИИ в брошюрах или в любых других рекламных материалах ПРОИЗВОДИТЕЛЯ носит исключительно иллюстративный характер и не обязательно отражает конечный эстетический результат установки этого конкретного продукта.

3.5. ПРОИЗВОДИТЕЛЬ гарантирует хорошее качество и отсутствие брака поставляемой ПРОДУКЦИИ. Гарантия не распространяется на ТОВАРЫ, классифицированные ПРОИЗВОДИТЕЛЕМ, как худшие по качеству, по 1-му выбору, или на те запасы продукции, которые были сняты с производства, когда они продаются оптом или указаны как специальные партии.

3.6. ПРОИЗВОДИТЕЛЬ не несет ответственности за любые дефекты и/или anomalies, обнаруженные в ПРОДУКЦИИ, которые не являются следствием технических характеристик этих материалов, а являются результатом неправильного использования ПРОДУКЦИИ покупателями и/или третьими лицами, действующими от их имени. В частности, ПРОИЗВОДИТЕЛЬ не принимает никаких претензий или споров, связанных с ситуациями, описанными выше.

3.7. Претензии, связанные с наличием патентных или скрытых дефектов, должны быть предъявлены покупателем в письменной форме в адрес ПРОИЗВОДИТЕЛЯ в течение 60 дней с даты доставки товара. Ответственностью ПРОИЗВОДИТЕЛЯ за дефекты, присущие товарам, доставленных покупателю, конкретно ограничена сроком в 2 года с даты получения товара покупателем.

3.8. Как правило, гарантия распространяется только на дефекты, обнаруженные в продукции, которая еще не была применена. В отношении дефектов, обнаруженных после применения ПРОДУКТОВ, гарантия действует только в том случае, если ПРОИЗВОДИТЕЛЬ подтвердил, что применение ПРОДУКТА было выполнено в соответствии с лучшими правилами деятельности (DIN 18352), а также в соответствии с процедурами, описанными ПРОИЗВОДИТЕЛЕМ в руководстве по применению и эксплуатации.

3.9. Гарантия, предоставляемая ПРОИЗВОДИТЕЛЕМ, ограничивается заменой дефектных продуктов на другие продукты того же типа, без дефектов, включая стоимость доставки. Возмещение любых других затрат и/или расходов и, в частности, затрат на снос и замену, категорически исключается. В любом случае, гарантия ПРОИЗВОДИТЕЛЯ не может превысить пятикратную стоимость востребованного продукта, до максимальной стоимости 10.000 евро.

3.10. ПРОИЗВОДИТЕЛЬ не несет ответственности за какие-либо претензии в связи с классификацией керамических материалов, проводимой органами сертификации и контроля, отличной от европейской, указанной в статье 3.1, на основании технических характеристик, не соответствующих указанным ПРОИЗВОДИТЕЛЕМ. Любой, возможный специализированный технический анализ, запрошенный покупателем, будет основан на соответствии продаваемых материалов техническим характеристикам, указанных ПРОИЗВОДИТЕЛЕМ, действующих, в настоящее время, в Португалии.

4 – Цены и условия оплаты

4.1. Продажные цены на ПРОДУКТЫ указаны в прейскуранте ПРОИЗВОДИТЕЛЯ, действующем на день подтверждения заказа. Для договоров купли-продажи с отдельными поставками стоимость будет соответствовать цене, указанной в прейскуранте, действующем на дату каждой поставки, если договаривающиеся стороны не указали иное направление.

Для ТОВАРОВ, предназначенных для зарубежных рынков, цена будет рассчитываться, по усанию ПРОИЗВОДИТЕЛЯ, в иностранной валюте страны назначения или в евро.

4.2. За исключением случаев, когда прямо оговорено иное, платежи будут производиться банковским переводом в течение 30 дней с даты выставления счета. Все банковские сборы и комиссии за перевод оплачивает покупатель. В случае задержки платежа ПРОИЗВОДИТЕЛЬ будет иметь право без необходимости предварительного уведомления покупателю применять штрафные процентные ставки, эквивалентные 6-месячной ставке EURIBOR плюс 5%, без ущерба для права на компенсацию за любые другие потери.

5 - Ответители производителя

5.1. Агенты ПРОИЗВОДИТЕЛЯ способствуют продаже ПРОДУКТОВ и не имеют права действовать от имени ПРОИЗВОДИТЕЛЯ, если только они не получат для этой цели специальное прямое разрешение.

5.2. Заказы, полученные агентами фирмы, не являются обязательными для ПРОИЗВОДИТЕЛЯ и поэтому должны быть письменно подтверждены самим ПРОИЗВОДИТЕЛЕМ.

6 – Право собственности

6.1. Между сторонами согласовано, что продажа ПРОДУКЦИИ осуществляется с правом собственности со стороны ПРОИЗВОДИТЕЛЯ до полной оплаты покупателем по согласованной цене. Однако риск потери товара переходит к покупателю при доставке ТОВАРА.

6.2. В случае продаж за границу, когда товары продаются и доставляются третьими лицами в рамках обычной коммерческой деятельности Покупателя и право собственности на товары еще не передано, право собственности ПРОИЗВОДИТЕЛЯ остается в силе с третьими сторонами.

6.3. В случае просрочки платежа, ПРОИЗВОДИТЕЛЬ имеет право, без необходимости прибегать к каким-либо формальностям, включая какое-либо предварительное уведомление покупателю, получить обратно все товары, подлежащие сохранению его праву собственности, и, если это законодательно закреплено, - все кредитные документы перед третьими лицами, сохраняя за собой право ПРОИЗВОДИТЕЛЯ, защищенное законом и имеющихся в распоряжении правовых средств, с целью компенсации понесенных убытков или возможных убытков, возникших в результате неисполнения обязательств Покупателем.

7 – Форс-мажорная ситуация

7.1. ПРОИЗВОДИТЕЛЬ не несет ответственности перед покупателем за любое нарушение договора, включая непоставку или несвоевременную доставку ТОВАРА, вызванные событиями, находящимися вне его контроля, например, недоставкой или задержкой доставки материалов от поставщиков, поломки оборудования, забастовок, стихийных бедствий, перебоев в подаче электроэнергии, приостановки или транспортных затруднений.

8 – Применимое законодательство – Компетентный Трибунал

8.1. Стороны соглашаются, что любые споры, касающиеся заключения, действительности, толкования или исполнения настоящего договора, подлежат исключительно юрисдикции судов по месту нахождения продавца, при этом прямо отказываясь от любой другой юрисдикции.

index

colour map

collections

linea collections

useful information

calibers

certification

general sales

conditions

important notes

laying suggestions

margres green

margres tools

outdoor extra thick

package

Protect

sustainable choice

symbols

technical information



2026

TABELA PREÇOS POR GRUPOS



MARGRES
CERAMIC TILES

TABELA DE PREÇOS 2026

Edição: Maio

código	preço / m²
MG-1015	17,60 €
MG-1040	20,65 €
MG-1055	25,30 €
MG-1080	33,80 €
MG-1160	26,20 €
MG-1220	23,00 €
MG-1240	23,65 €
MG-1245	24,60 €
MG-1270	25,25 €
MG-1330	23,65 €
MG-1450	30,00 €
MG-2095	27,50 €
MG-2105	27,50 €
MG-2125	29,50 €
MG-2205	33,90 €
MG-2235	35,55 €
MG-2370	30,75 €
MG-2570	33,95 €
MG-2650	40,35 €
MG-2765	28,30 €
MG-2775	28,30 €
MG-2780	28,30 €
MG-2785	28,30 €
MG-2795	29,50 €
MG-2810	30,35 €
MG-2870	34,80 €
MG-2890	36,45 €
MG-3070	31,55 €
MG-3080	31,55 €
MG-3095	31,55 €

código	preço / m²
MG-3250	34,75 €
MG-3280	34,75 €
MG-3330	41,30 €
MG-3425	36,40 €
MG-3475	44,55 €
MG-3560	28,95 €
MG-3580	28,95 €
MG-3730	32,15 €
MG-3955	32,15 €
MG-3960	32,15 €
MG-3970	32,15 €
MG-3985	32,15 €
MG-4010	34,55 €
MG-4045	38,85 €
MG-4055	34,40 €
MG-4100	40,55 €
MG-4290	35,45 €
MG-4470	38,65 €
MG-4485	38,65 €
MG-4540	45,35 €
MG-4680	30,60 €
MG-4695	30,60 €
MG-4720	32,65 €
MG-4730	33,00 €
MG-4760	30,60 €
MG-4790	38,75 €
MG-4805	37,20 €
MG-4850	33,80 €
MG-4865	36,20 €
MG-4950	32,20 €

código	preço / m²
MG-4970	33,85 €
MG-5160	37,05 €
MG-5210	37,05 €
MG-5250	43,75 €
MG-5450	39,10 €
MG-5490	42,25 €
MG-5700	43,80 €
MG-7090	41,90 €
MG-7180	43,70 €
MG-7290	43,70 €
MG-7490	61,75 €
MG-7690	64,00 €
MG-9515	33,00 €
MG-9520	35,00 €
MG-9525	42,30 €
MG-9570	91,90 €
MG-9580	103,55 €
MG-9590	114,85 €
MG-9640	166,70 €
MG-9660	180,10 €
MG-9715	45,35 €
MG-9720	63,05 €
MG-9730	70,35 €
MG-9735	83,45 €
MG-9740	85,00 €
MG-9745	103,55 €
MG-9790	180,10 €
MG-9830	114,85 €
MG-9835	119,50 €
MG-9885	180,10 €

LINHA

código	preço / m²
M3-1230	51,50 €
M3-1530	56,30 €
M3-2730	63,00 €
M3-3130	83,90 €
M3-3530	66,00 €
M3-3830	86,90 €

código	preço / m²
M3-4230	66,00 €
M3-4630	86,90 €
M3-4930	108,00 €
M3-5730	48,90 €
M3-6230	53,05 €
M3-6730	53,05 €

código	preço / m²
M3-6780	57,80 €
M3-7300	61,50 €
M3-7730	61,50 €
M3-8230	61,50 €
M3-8270	65,00 €

MARGRES
CERAMIC TILES

preços sem I.V.A.

TABELA DE PREÇOS 2026

Edição: Maio

código	preço / un
MP-6040	2,15 €
MP-6080	3,75 €
MP-6150	7,05 €
MP-6170	7,45 €
MP-6180	8,95 €
MP-6200	9,30 €
MP-6230	11,05 €
MP-6240	12,00 €
MP-6260	12,75 €
MP-6270	13,30 €
MP-6310	16,20 €
MP-6320	17,30 €
MP-6330	18,70 €
MP-6350	20,70 €
MP-6370	23,10 €
MP-6380	24,25 €
MP-6400	26,50 €
MP-6415	29,05 €
MP-6430	29,95 €
MP-6445	32,95 €
MP-6470	39,15 €

código	preço / un
MP-6488	42,85 €
MP-6490	29,85 €
MP-6500	51,20 €
MP-6520	54,15 €
MP-6560	73,60 €
MP-6580	82,75 €
MP-6590	86,65 €
MP-6595	99,35 €
MP-6620	68,35 €
MP-6630	109,15 €
MP-6640	107,00 €
MP-6645	122,30 €
MP-6650	128,20 €
MP-6655	140,65 €
MP-6670	132,10 €
MP-6680	142,50 €
MP-6685	146,45 €
MP-6690	149,35 €
MP-6700	155,40 €
MP-6710	187,85 €
MP-6740	213,95 €

embalagens e acessórios		
artigo	código	preço* / un
k-blade	P3-0120	18,90 €
100x250 caixa	P3-0510	120,00 €
100x300 caixa		
120x260 caixa	P3-0530	150,00 €
120x278 caixa		

*preços líquidos sem desconto

MARGRES

CERAMIC TILES

